

# **Advantage<sup>®</sup>**

**Maintenance Products Ltd.**



**519-470-6000**  
**1-855-470-6001**

**Georgian Bay Chemical**

**121 Jason Street, Owen Sound, ON N4K 5N7 (Springmount Business Park)**  
**www.GeorgianBayChemical.com Fax : 866-370-2527**  
**info@georgianbaychemical.com**

# 2015 SUPPLY CATALOGUE

Within the pages of this catalogue you will find thousands of products used by businesses everyday. We have strived to offer a comprehensive listing of products, yet there may be something special you need. If you don't find your required item on the pages of the catalogue or in the index at the back of the book, call us. We can special order many additional items.

---

---

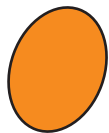

## Washroom Accessories & Supplies

Accessoires & Fournitures  
pour Salle de Toilette

Pages 1 - 27

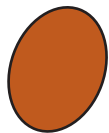

## Floor & Wall Maintenance

Entretien des Murs & Planchers

Pages 28 - 48

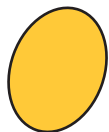

## Mopping Equipment

Équipement de Lavage de Plancher

Pages 49 - 56

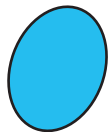

## Brooms, Brushes & Accessories

Balais, Brosses & Accessoires

Pages 57 - 67

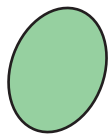

## Waste Receptacles

Contenants de Récupération et de Déchets

Pages 68 - 82

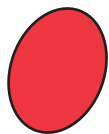

## Aerosols

Aérosols

Pages 83 - 91

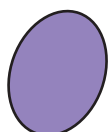

## Wipes & Wiping Cloths

Lingette Humide

Pages 92 - 98

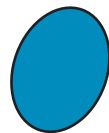

## Cleaning Chemicals & Air Fresheners

Produits Chimiques de Nettoyage &  
Rafraîchisseur d'Air

Pages 99 - 109

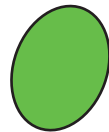

## Trigger Sprayers & Bottles

Bouteilles & Vaporisateurs

Pages 110 - 113

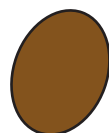

## Pumps & Dispensers

Pompes & Équipements de Mesure

Pages 114 - 120

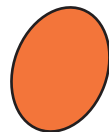

## Window Cleaning Tools

Outils pour Nettoyage de Vitres

Pages 121 - 129

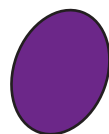

## Safety & Security Products

Produits de Sécurité et de Protection

Pages 130 - 134



## Material Handling

Équipement de Manutention

Pages 135 - 143

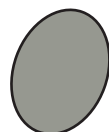

## Auto Detailing

Auto Detailing

Pages 144 - 149



**New Products** – Products designated with a New Products logo are items that are recent inclusions to our product offerings and have may not been featured in a previous catalogue.



**Best Buy** – Over the past few years there has been a significant drive, in all industries, to reduce the cost-of-goods. Items that are marked with the Best Buy symbol are products that we believe offer the best value for money.



**Special Order** – Items identified with the Special Order symbol indicate this item may not be in stock, in all our branches. Contact your representative about availability or delivery times.



**Earth Choice** – The U.S. Environmental Protection Agency's Design for the Environment (DfE) review team has screened each ingredient in the product for potential human health and environmental effects. The product contains only those ingredients that pose the least concern among chemicals in their class.



**CFIA** – The Canadian Food Inspection Agency, is the regulatory body with responsibility for maintaining the high standards of the Canadian food industry. Items marked with the CFIA logo are considered safe for use in situations where casual and incidental contact with food may occur.



**Underwriters Laboratory** – The Advantage UL Classified Wastebaskets meet the UL performance criteria for open, non-metallic wastepaper containers and their ability to contain fire.



**Factory Mutual** – FM is an independent testing agency that approves covered containers based on their ability to withstand an internal fire by the elimination/reduction of oxygen intake.



**California State Fire Marshal** – The state of California is often believed to be the most stringent of all the North American jurisdictions on their fire codes. Once a product has obtained UL and/or FM approval, they are submitted to California for acceptance.



**NSF** – National Sanitation Foundation is an independent testing laboratory that lists product which meet their criteria for cleanability and sanitation in the areas of food contact and splash zone.



**USDA** – The United States Department of Agriculture sets regulations for the construction of material of equipment for use and/or contact with meat poultry and dairy production.



# Washroom Accessories & Supplies

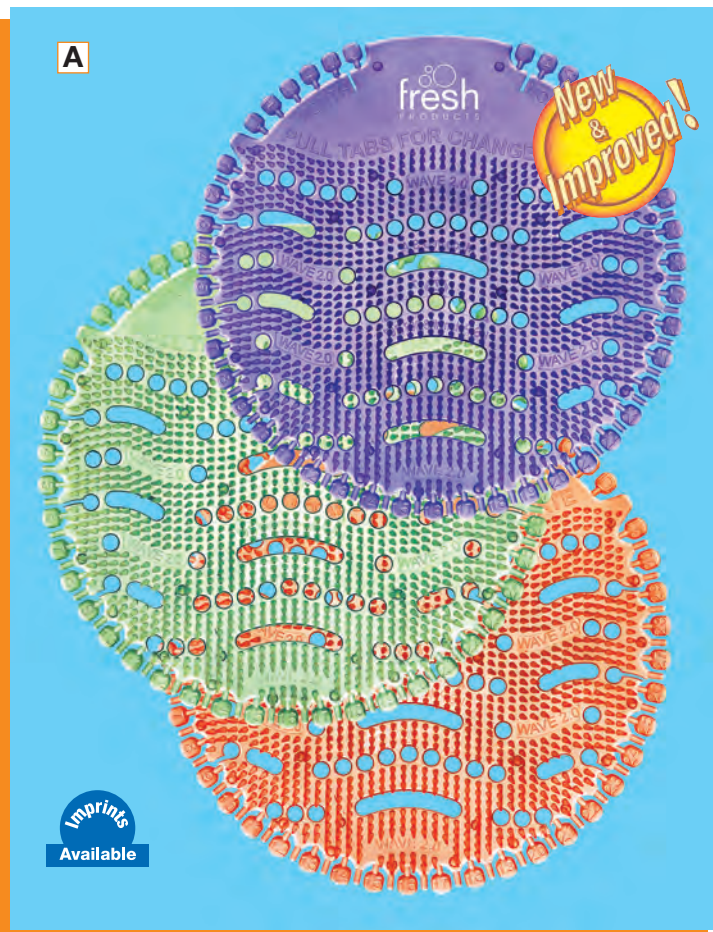

## Eco Fresh System

### A The Wave 2.0 Urinal Screen

- New & improved design
- Pull off the date tabs upon installation to remind you when to change the air freshener
- Includes one "Screen Saver" bag per box to store the spare screen until needed
- Freshens Urinal a full 30 Days; twice as much as the competitors
- Releases billions of optimized bacteria that clean the urinal and eliminate odours
- Longer protrusions release fragrance and reduce splashback
- Cuts cleaning time by up 50% while saving money
- Complies with VOC Requirements

20HM	Herbal Mint	10/bx	1 lb
20HS	Honeysuckle	10/bx	1 lb
20KG	Kiwi Grapefruit	10/bx	1 lb
20FB	Fabulous	10/bx	1 lb
20WG	Wintergreen	10/bx	1 lb
20OM	Ocean Mist	10/bx	1 lb
20MG	Mango	10/bx	1 lb
20CT	Citrus	10/bx	1 lb
20SA	Spiced Apple	10/bx	1 lb
20CB	Cotton Blossom	10/bx	1 lb
20GP	Guava Pineapple	10/bx	1 lb
20CM	Cucumber Melon	10/bx	1 lb

### B The Dome Urinal Screen

- Fragrances last 60 days, twice as long as any other urinal screen; purchase 50% fewer screens, reducing costs
- Date tabs remind you when to change it
- Unique non-splash dome design minimizes over-spray on floors walls and partitions
- Perfect for high domed waterless urinal cartridges and raised drains
- Contains billions of beneficial bacteria that consume the source of drain odours
- Dome design eliminates floating and movement in the urinal

RUS30HM	Herbal Mint	5/bx	1.4 lb
RUS30MG	Mango	5/bx	1.4 lb
RUS30CT	Citrus	5/bx	1.4 lb
RUS30SA	Spiced Apple	5/bx	1.4 lb
RUS30CB	Cotton Blossom	5/bx	1.4 lb
RUS30CM	Cucumber Melon	5/bx	1.4 lb



### Fragrance Intensity Chart

Herbal Mint	
Honeysuckle	
Kiwi Grapefruit	
Fabulous	
Wintergreen	
Ocean Mist	
Mango	
Citrus	
Spiced Apple	
Cotton Blossom	
Guava Pineapple	
Cucumber Melon	

## Eco Fresh System

### A Eco Clip

- Freshens the air for 30 days or more
- Unique patent-pending material contains 30 times more air freshener than standard rim sticks
- Environmentally Friendly; low VOC's
- 100% recyclable; will not dissolve in or pollute water
- Fits most standard toilets; clips on outside of bowl
- Also clips on toilet tank, bathroom partition, etc.

<b>EBC72HM</b>	Herbal Mint	12/cs	1.6 lb
<b>EBC72HS</b> ♦	Honeysuckle	12/cs	1.6 lb
<b>EBC72KG</b> ♦	Kiwi Grapefruit	12/cs	1.6 lb
<b>EBC72FB</b> ♦	Fabulous	12/cs	1.6 lb
<b>EBC72OM</b> ♦	Ocean Mist	12/cs	1.6 lb
<b>EBC72MG</b>	Mango	12/cs	1.6 lb
<b>EBC72CT</b> ♦	Citrus	12/cs	1.6 lb
<b>EBC72SA</b>	Spiced Apple	12/cs	1.6 lb
<b>EBC72CB</b>	Cotton Blossom	12/cs	1.6 lb
<b>EBC72GP</b> ♦	Guava Pineapple	12/cs	1.6 lb
<b>EBC72CM</b>	Cucumber Melon	12/cs	1.6 lb



### B Eco Air Passive 30-Day Air Freshener

- Unique fragrances are designed for month long performance without batteries or fans
- Easy to use – Fits TC®, TimeMist®, Ecolab®, Hospeco®, Kimberly-Clark®, Vectair® and fan dispensers too
- Cannot spill or break; 100% recyclable
- Use in restroom stalls, on restroom walls, conference rooms, entry ways, lobbies, trash rooms and near soiled linens

<b>EA36HM</b>	Herbal Mint	6/cs	1.3 lb
<b>EA36KG</b> ♦	Kiwi Grapefruit	6/cs	1.3 lb
<b>EA36FB</b> ♦	Fabulous	6/cs	1.3 lb
<b>EA36MG</b>	Mango	6/cs	1.3 lb
<b>EA36CT</b>	Citrus	6/cs	1.3 lb
<b>EA36SA</b>	Spiced Apple	6/cs	1.3 lb
<b>EA36CB</b>	Cotton Blossom	6/cs	1.3 lb
<b>EA36CM</b> ♦	Cucumber Melon	6/cs	1.3 lb
<b>EACAB2</b>	Eco Air Cabinet	12/cs	2.0 lb



### C Eco Fresh Hang Tags

- 100% more fragrance than typical air fresheners
- Versatile - hang it in places like a stall doorstop, toilet handle, fan cabinets, etc.
- Environmentally friendly when compared to most gel or metered aerosol air fresheners

<b>72HM</b>	Herbal Mint	12/cs	1.7 lb
<b>72HS</b>	Honeysuckle	12/cs	1.7 lb
<b>72KG</b> ♦	Kiwi Grapefruit	12/cs	1.7 lb
<b>72WG</b>	Wintergreen	12/cs	1.7 lb
<b>72OM</b> ♦	Ocean Mist	12/cs	1.7 lb
<b>72MG</b>	Mango	12/cs	1.7 lb
<b>72CT</b> ♦	Citrus	12/cs	1.7 lb
<b>72SA</b>	Spiced Apple	12/cs	1.7 lb
<b>72CB</b>	Cotton Blossom	12/cs	1.7 lb
<b>72GP</b> ♦	Guava Pineapple	12/cs	1.7 lb
<b>72CM</b> ♦	Cucumber Melon	12/cs	1.7 lb
<b>1114</b>	Suction Cups	12/bg	0.1 lb



♦ Non-stocked item requires special order



## Eco Fresh System

### A Easy Fresh

- The only air freshener that uses the cover of the dispenser as the air freshener itself; no locks - remove the old cover and replace it
- Powerful enough to freshen large areas; contains 2 - 3 times more fragrance than most gels or metered aerosols
- VOC compliant and works continuously; no peaks of freshness
- Air freshener lasts consistently for 30 days or more
- The computerized fan turns sparingly in week 1 and gradually turns more frequently until week 4 when the fan turns constantly

#### Refills with Battery

EF12HM	Herbal Mint	12/bx	4 lb
EF12HS	Honeysuckle	12/bx	4 lb
EF12KG	Kiwi Grapefruit	12/bx	4 lb
EF12FB	Fabulous	12/bx	4 lb
EF12OM	Ocean Mist	12/bx	4 lb
EF12MG	Mango	12/bx	4 lb
EF12CT	Citrus	12/bx	4 lb
EF12SA	Spiced Apple	12/bx	4 lb
EF12CB	Cotton Blossom	12/bx	4 lb
EF12GP	Guava Pineapple	12/bx	4 lb
EF12CM	Cucumber Melon	12/bx	4 lb

#### Refills without Battery

EF12NBHM	Herbal Mint	12/bx	2 lb
EF12NBHS	Honeysuckle	12/bx	2 lb
EF12NBKG	Kiwi Grapefruit	12/bx	2 lb
EF12NBFB	Fabulous	12/bx	2 lb
EF12NBOM	Ocean Mist	12/bx	2 lb
EF12NBMG	Mango	12/bx	2 lb
EF12NBCT	Citrus	12/bx	2 lb
EF12NBSA	Spiced Apple	12/bx	2 lb
EF12NBCB	Cotton Blossom	12/bx	2 lb
EF12NBGP	Guava Pineapple	12/bx	2 lb
EF12NBCM	Cucumber Melon	12/bx	2 lb

#### Dispensers

- Choose from a passive or battery operated dispenser
- Fan unit has LED indicators; Green Light = Good, Red Light = Replace the cover, No Light = Needs cover and battery, Audible Alert = change the cover (after 33 days, "chirps every 3 minutes)
- Push button release resets the program for the 30-day refill

EFCABP	Passive Dispenser	24/cs	0.8 lb
EFCABPE	Fan Dispenser	12/cs	4 lb

### B The Curve Air Freshener

- Using the date tabs, you'll know when to replace it
- Place or hide the Curve almost anywhere - on the side of toilets, inside bathroom cabinets, on the underside of trash can lids, etc.
- Contains 50 times more fragrance than a standard toilet rimstick; freshening for a full 30 days

RC30HM	Herbal Mint	10/bx	1 lb
RC30MG	Mango	10/bx	1 lb
RC30CT	Citrus	10/bx	1 lb
RC30SA	Spiced Apple	10/bx	1 lb
RC30CB	Cotton Blossom	10/bx	1 lb
RC30CM	Cucumber Melon	10/bx	1 lb
RC30FB	Fabulous	10/bx	1 lb
RCCAB	Curve Holder	30/cs	1 lb

## Foam·eeze Soap Dispensers

### A Foam·eeze Bulk Foam Soap Dispenser

- Sleek, smooth modern design complements any décor
- Made of durable ABS for extended lifetime
- Key lock for maximum security or optional universal access
- 1000 mL (33.8 oz) refillable bottle features vented, large screw cap for easy refilling
- Replacement bottle and foam pump mechanism available (9325B)
- Refillable bottle is easily removed for cleaning and refilling or it can be refilled while still in the dispenser
- Accepts bulk foam soap and sanitizers

9325	White	1000 mL/33.8 oz	12/cs	15 lb
9326	Black	1000 mL/33.8 oz	12/cs	15 lb

### B Encore Foam·eeze Bulk Foam Soap Dispenser

- Can be easily removed from mounted back plate
- Smaller, compact design fits in tight spaces
- Helps keep sinks, countertops and floors clean
- Accepts bulk foam soap and sanitizers

9335	White	900 mL/30 oz	12/cs	10 lb
9336	Grey	900 mL/30 oz	12/cs	10 lb

### C ClearVu Foam·eeze Bulk Foam Soap Dispenser

- Can be easily removed from mounted back plate
- Hidden security lock prevents vandalism
- Large reservoir provides 10-30% more soap than captive systems
- Fewer refills; less real labour and environment savings
- Helps keep sinks, countertops and floors clean

9344	White	1360 mL/46 oz	12/cs	18 lb
9345	Grey	1360 mL/46 oz	12/cs	18 lb



## Hands-Free Bulk Foam Dispensers

### D Foam·eeze Hands-Free Bulk Foam Soap Dispenser

- Dispenses automatically; reduces risk of contamination
- Accepts most bulk foam soap and sanitizers
- Key lock for maximum security
- Refillable bottle features a vented, large screw cap for easy refilling and can be used long-term, reducing waste
- Battery operated; batteries will last for 50,000 strokes (approximately 6 months)
- Replacement bottle and foam pump mechanism available (9327B)

9327	White	1000 mL/33.8 oz	12/cs	28 lb
9328	Metallic	1000 mL/33.8 oz	12/cs	28 lb



**NOTE:** Bulk Foam and Lotion Soap Available - See Page 9

❖ **Non-stocked item requires special order**





## Counter Mount Foam Dispensers

### A TidyFoam Counter Mount Foaming Dispenser

- Universal fit designed to accommodate the location and diameter of most existing installations
- Top fill - no more crawling around on the floor or waiting for the cartridge to empty before refilling
- Unique design prevents over-filling or spilling - no funnels required
- Operates with one hand; requires less than 5 lb of pressure to dispense product
- Approximately 1300 shots per 1000 mL

<b>A8800F</b>	Ivory	1000 mL/34 oz	6/cs	10 lb
<b>A8801F</b>	Black	1000 mL/34 oz	6/cs	10 lb
<b>A8802F</b>	Chrome	1000 mL/34 oz	6/cs	10 lb

### Soap Refills

#### TidyFoam Pink Hand Soap

- Pink colour; tropical fragrance
- Green Seal Certified

<b>A7809F</b>		1000 mL/34 oz	4/cs	10 lb
---------------	--	---------------	------	-------

#### TidyFoam Antibacterial Moisture Wash

- Light pink colour; grapefruit fragrance

<b>A7810F</b>		1000 mL/34 oz	4/cs	10 lb
---------------	--	---------------	------	-------

## Metal Soap Dispensers



### B Metal Powder Soap Dispenser

- 4" opening top-fill with service key
- Dimensions: 4 $\frac{1}{2}$ " D x 4 $\frac{1}{8}$ " W x 7 $\frac{1}{8}$ " H

<b>4010MP</b>	Chrome	946 mL/32 oz	24/cs	48 lb
---------------	--------	--------------	-------	-------

### C Vertical Tank Style Soap Dispenser

- Surface mounted; Lucite soap level indicator window
- Drawn and welded construction of 20 ga. stainless steel
- Easy refill at top; keyed lock filler cap
- Dispenses liquid soap and more viscous synthetic detergents, lotions and antiseptic soaps

<b>708A</b>		1182 mL/40 oz	24/cs	48 lb
-------------	--	---------------	-------	-------

### D Horizontal Tank Style Soap Dispenser

- Surface mounted; Lucite soap level indicator window
- Drawn and welded construction of 20 ga. stainless steel
- Easy refill at top; keyed lock filler cap
- Dispenses liquid soap, detergents, lotions and antiseptic soaps

<b>710A</b>		1182 mL/40 oz	24/cs	48 lb
-------------	--	---------------	-------	-------

## Lotion Soap Dispensers



### E Bulk Lotion Soap Dispenser

- Modern design complements any decor; made of durable ABS for extended lifetime
- Sight window indicates level of soap remaining
- ADA compliant pushbar
- Key lock for maximum security or optional universal access
- Refillable bottle reduces environmental waste; features vented large screw cap for easy refilling
- Dispenses 0.7 ml of liquid in the form of liquid soap
- Recyclable bottle marked "LIQUID SOAP" to insure proper use

<b>9390</b>	White	1000 mL/34 oz	12/cs	15 lb
<b>9391</b>	Black	1000 mL/34 oz	12/cs	15 lb

## Lotion Soap Dispensers

### A 9330 ClearVu Encore™ Dispenser

- 30 oz capacity tank and hidden, removable backplate
- Unique water resistant top, ideal for showers
- Accommodates a wide variety of liquid and lotion soaps including antibacterial, antiseptic and antimicrobial soaps
- Does not accept pumice
- Dispenses approximately 1 cc/stroke depending on soap viscosity; large push bar meets ADA requirements
- Dimensions: 4" D x 4½" W x 6¼" H

9330WT	White	30 oz	12/cs	11 lb
9331	Grey	30 oz	12/cs	11 lb

### B 9346 ClearVu™ Dispenser

- Accommodates a wide variety of liquid and lotion soaps including antibacterial, antiseptic and antimicrobial soaps
- Does not accept pumice or grit soap
- Hidden security key lock prevents vandalism
- Smooth curved design easy to clean and maintain; prevents bacteria growth and unsightly smoke burns
- Dispenses approximately 1 cc/stroke depending on soap viscosity; large push bar meets ADA requirements
- Dimensions: 4¼" D x 5½" W x 8½" H

9346	White	46 oz	12/cs	15 lb
9347	Grey	46 oz	12/cs	15 lb

### C 9350 Triad™ Soap Dispenser

- Versatile push plunger valve dispenses 0.9 cc or more per stroke
- Hidden security key lock prevents vandalism
- Accommodates many soap types except pumice
- Easily installed, removable backplate for easy mounting
- Meets ADA requirements
- Dimensions: 4¼" D x 4¾" W x 7½" H

9350	Tan	50 oz	12/cs	16 lb
9351	Grey	50 oz	12/cs	16 lb

### D 9352 Deluxe Triad™ Soap Dispenser

- Large capacity see-thru tank allows for easy view of soap level
- Versatile push plunger valve dispenses 0.9 cc or more per stroke
- Hidden security key lock prevents vandalism
- Accommodates many soap types except pumice
- Easily installed, removable backplate for easy mounting
- Meets ADA requirements
- Dimensions: 4¼" D x 4¾" W x 7½" H

9352	Grey	50 oz	12/cs	16 lb
9356	Black	50 oz	12/cs	16 lb
9354	White	50 oz	12/cs	16 lb

### E Soft Touch™ Deluxe Tank Soap Dispenser

- 36 oz capacity; dispenses 1 to 1.4 cc per stroke
- "Soft Touch" push bar operation
- Dimensions: 4½" D x 5" W x 7½" H

235	White	1065 mL/36 oz	12/cs	12.5 lb
23550	Black	1065 mL/36 oz	12/cs	12.5 lb

### F Counter Mounted Soap Dispenser

- Free turning 4" spout; Mounts through 7/8" diameter hole
- Designed for end spout to extend over bowl
- Dimensions: 3½" Dia. x 11" H

4032	Chrome	946 mL/32 oz	24/cs	29 lb
------	--------	--------------	-------	-------





## Bladder Soap Systems

### A AMA 1000 mL Foaming Soap Dispenser

- Guaranteed leak proof and ADA compliant
- Economical to use and secured with a keyed locking system
- Multi purpose view window to monitor the soap level
- Dispenses 0.75 mL per stroke

<b>A8798F</b>	Black	1000 mL	6/cs	6 lb
<b>A8799F</b>	Grey	1000 mL	6/cs	6 lb

### B TidyClean No Touch Foam Soap Dispenser

- Economical choice; top-mounted valve eliminates leaks
- Modular battery pack can be changed without tools
- Optional key locking mode available
- LED indicator lights show when dispenser is activated and when batteries are low
- Bag-only refill reduces packaging waste by 50%

<b>A7990F</b> ♦	Grey	1000 mL	6/cs	23 lb
<b>A7991F</b> ♦	Black	1000 mL	6/cs	23 lb



### C Premium Series Soap Dispensers

- Unique top-dispensing technology – no risk of leaking valves
- You can see the product being dispensed; no extra pushes
- Durable plastic with no metal parts; ideal for wet or dry conditions
- ADA compliant with a secured locking option
- Dispenses only .75 mL per hand wash versus 1.5 mL for most bag-in-a-box systems

<b>A8900F</b>	Black	1000 mL	6/cs	10 lb
<b>A8901F</b>	Grey	1000 mL	6/cs	10 lb
<b>A8902F</b>	White	1000 mL	6/cs	10 lb

#### Hands-Free Option

<b>A8910F</b>	Black	1000 mL	6/cs	15 lb
<b>A8911F</b>	Grey	1000 mL	6/cs	15 lb
<b>A8912F</b>	White	1000 mL	6/cs	15 lb

### D TidyFoam Pink Hand Soap

- Mild concentrated hand soap with emollients glycerin and lanolin, pH balanced and biodegradable
- General purpose hand cleaner; Green Seal certified

<b>A7800F</b>	1000 mL	6/cs	15 lb
---------------	---------	------	-------



### E Foaming Instant Hand Sanitizer - No Alcohol

- Sanitizes hands when soap and water are not available
- Formulated with 0.2% Benzethonium Chloride to eliminate 99.9% of common germs within 15 seconds; non-flammable
- Enhanced with Aloe Vera and Vitamin E to moisturize skin
- No medicinal odour; dye free with a light linen fragrance

<b>A7808F</b>	1000 mL	6/cs	15 lb
---------------	---------	------	-------

### F TidyFoam Instant Hand Sanitizer - Alcohol

- Fast-acting product kills 99.9% of common germs within 15 sec
- Ethyl alcohol (62%) formula; for the highest hand antisepsis
- No water or rinsing needed; just rub in and let dry
- No added dye or fragrance

<b>A7820F</b>	1000 mL	6/cs	15 lb
---------------	---------	------	-------

### G Antibacterial Hand Cleanser with Triclosan

- Hand soap and lotion with Triclosan (.5%); 7.0 pH, 4000 cps
- Kills a wide variety of disease causing bacteria and fungi viruses on contact to provide antiseptic cleansing
- Recommended for use in hospitals, food establishments, etc.

<b>A7802F</b>	1000 mL	6/cs	15 lb
---------------	---------	------	-------

## Hygiene Station

### A Hygiene Station Floor Stand

- Matte silver finished stand design that's easy to assemble
- Lightweight; two dispensing heights - standard (44") and low (40.5"), ideal for schools
- Includes 6 1/4" x 8" customizable message holder with generic hand hygiene message
- Best used with TidyClean No Touch Foam Dispenser or Premium Designs Dispensers shown on **page 7**

<b>9938</b>	Floor Stand	1/cs	13.5 lb
-------------	-------------	------	---------

## Bag-in-a-Box Soap Systems

### B AMA 800 mL Soap Dispenser

- New contemporary space-saving design
- Dispenses 1.5 mL per stroke; each bag-in-a-box refill contains approximately 533 hand washes
- Keyless locking system; window to view soap level
- Push lever is ADA compliant
- Easy installation - just peel and stick

<b>A7898</b>	Black	800 mL	12/cs	12 lb
<b>A7899</b>	White	800 mL	12/cs	12 lb

### C Pink Grapefruit Lotion Hand Cleaner

- Mild concentrated hand soap with emollients glycerin and lanolin, pH balanced and biodegradable
- General purpose hand cleaner

<b>A7800</b>	800 mL	12/cs	25 lb
--------------	--------	-------	-------

### D Instant Hand Sanitizer

- Waterless, topical antimicrobial hand sanitizer gel
- Evaporates instantly to leave hands soft and smooth
- Ethyl alcohol (62%) formula; for the highest hand antiseptics
- Ideal for non-surgical areas where water is not available
- Complies with OSHA's Bloodborne Pathogens Std. 6.0-7.0 pH; 9000 cps +/- 1,000 cps

<b>A7808</b>	800 mL	12/cs	25 lb
--------------	--------	-------	-------

### E Hair and Body Shampoo

- Complete body wash, ideal for health clubs and spa's
- Refreshing pH balanced clear blue formula
- Formulation contains conditioners for skin and hair
- Quick sudsing, universally appealing Aloe fragrance

<b>A7805</b>	800 mL	12/cs	25 lb
--------------	--------	-------	-------

### F Antibacterial Hand Cleanser with Triclosan

- Hand soap and lotion with the remarkable germ fighting ingredient Triclosan (.03%); 7.0 pH, 4000 cps
- Kills a wide variety of disease causing bacteria and fungi viruses on contact to provide antiseptic cleansing
- Reduces the growth of bacteria, long after washing
- Recommended for use in hospitals, food establishments, etc.

<b>A7802</b>	800 mL	12/cs	25 lb
--------------	--------	-------	-------

❖ Non-stocked item requires special order





## Foaming Hand Soaps

### A TidyFoam Luxury Hand Soap

- Foaming luxury hand soap
- Pink, tropical fragrance
- Formulated to be used in foaming dispensers

<b>A7700F</b>	3.78 L/1 US Gal	4/cs	37 lb
---------------	-----------------	------	-------

### B TidyFoam Bulk Antibacterial Hand Soap

- Hand soap with Triclosan
- Contains a germ fighting ingredient proven to kill a broad spectrum of germs and bacteria
- Mild, yet effective
- Golden amber colour and pleasant Citrus-Spice fragrance

<b>A7702F</b>	3.78 L/1 US Gal	4/cs	37 lb
---------------	-----------------	------	-------

## Hand Soaps

### C TidyPearl Bulk Pink Grapefruit Lotion Soap

- High sudsing, general purpose soap
- Great for medium to heavy soil removal
- Pleasant grapefruit scent; pink colour

<b>A78044</b>	3.78 L/1 US Gal	4/cs	37 lb
---------------	-----------------	------	-------

### D TidyBac<sup>®</sup> Bulk Antibacterial Hand Soap

- Hand cleanser with Triclosan; mild, yet effective
- Contains a germ fighting ingredient proven to kill a broad spectrum of germs and bacteria
- Golden amber colour and pleasant Spicy Floral fragrance

<b>A78024</b>	3.78 L/1 US Gal	4/cs	37 lb
---------------	-----------------	------	-------

### E TidyBac<sup>®</sup> Antibacterial Hand Soap

- Most popular antibacterial product
- Formulated with .3% Triclosan
- Effective against VRE, MRSA, and salmonella
- Spicy Floral scent; moisturizes and deodorizes
- Refillable 8 oz/237 mL pump bottle

<b>A7832</b>	237 mL/8 oz	12/cs	7 lb
--------------	-------------	-------	------

### F Enviro Care<sup>®</sup> Bulk Hand Soap

- Biobased with a thick lather
- Biodegradable; dye free
- No fragrance

<b>11259336</b>	1 US gal/3.78 L	4/cs	37 lb
-----------------	-----------------	------	-------

### G Foaming Antibacterial Hand Cleaner

- Clean shape combines the convenience and hygiene of disposable containers with the style of premium fixtures
- Formulated with 0.5% Triclosan germ fighter
- Amber colour and citrus spice fragrance

<b>A7812</b>	950 mL	4/cs	10 lb
--------------	--------	------	-------

### H Foaming Pink Hand Cleaner

- Mild foaming soap with emollients; removes dirt and oil
- pH balanced and biodegradable, pink colour, tropical scent

<b>A7811</b>	950 mL	4/cs	10 lb
--------------	--------	------	-------

### I Bracket for Foaming Hand Cleaners

- For added security and convenience
- Helps keep counter areas clear

<b>9907ZPL</b>	Grey	24/cs	2 lb
----------------	------	-------	------

## Hands Free Soap Dispenser

### A OneShot® Automatic Soap System

- Cost-effective controlled dosing (1000 hand washes per 800 mL refill); reduces soap usage and waste
- New pump and delivery tube with every refill; always clean and working, no more clogs and drips
- Easy 5 minute installation; fits existing opening and a quick-twist “one-handed” refill
- Sophisticated sensor technology guarantees delivery, promotes health and prevents the spread of infectious diseases
- 4 “D” Batteries not included - **see page 14**

401310	Chrome	800 mL	4/cs	10 lb
--------	--------	--------	------	-------

### B OneShot® Automatic Foam Soap System

- Patented Smart Sensor™ technology detects hands, automatically delivering the perfect amount of soap every time
- Helps earn LEED credits
- Touch-free delivery eliminates cross-contamination to help reduce the spread of germs and encourages use
- Controlled dispensing of concentrated soaps eliminates over use and costly waste
- Highest yield of hand washes — up to 1000 per refill
- 4 “D” Batteries not included - **see page 14**

750339	Chrome	800 mL	4/cs	10 lb
--------	--------	--------	------	-------

## OneShot® Refill Lotion Soap

### C Lotion Soap with Moisturizer

- Rich, luxurious hand soap with special moisturizing ingredients including Glycerin, Aloe Vera and Vitamin E, to help soothe and soften skin
- Produces a thick, rich lather; contains 1000 soap shots
- Unique fresh floral scent

4013111		800 mL	4/cs	9 lb
---------	--	--------	------	------

### D Enriched Lotion Free ‘N Clean Soap

- Enriched with Glycerin, Silk Proteins, Aloe Vera, and Vitamin E
- Hypoallergenic for sensitive skin; dye-free and fragrance-free
- Biodegradable

402363		800 mL	4/cs	9 lb
--------	--	--------	------	------

### E Enriched Foam Free ‘N Clean Soap

- Green Seal™ certified
- Enriched with skin conditioners; pH balanced
- NSF E1 rated for food handlers, leaves no scent
- Dye-free and fragrance-free; biodegradable

750389		800 mL	4/cs	9 lb
--------	--	--------	------	------

### F Enriched Foam Soap with Moisturizers

- Green Seal™ certified
- Enriched with skin conditioners; pH balanced
- Fresh light citrus fragrance; rich teal color
- Biodegradable

750517		800 mL	4/cs	9.5 lb
--------	--	--------	------	--------

### G Green Certified Lotion Soap

- Green Seal™ certified; biodegradable
- Hypoallergenic for sensitive skin
- Fresh light honeysuckle fragrance

4013131		800 mL	4/cs	9 lb
---------	--	--------	------	------



## Toilet Tissue Dispensers

**A**



### **A Jumbo Toilet Tissue Dispenser**

- Ideal for high traffic areas requiring the durability of an all-metal exterior
- Holds two 9" (230 mm) jumbo toilet tissue rolls
- Moulded spindles can accommodate 2 ¼" or 3" (57 or 76 mm) diameter cores
- Spring loaded access tray will lock into position only when first roll on left side is depleted and will return to original position when door is opened
- Single viewing slot reveals tissue
- Equipped with tumbler lock
- Dimensions for 169: 5¾" D x 20½" W x 11¼" H
- Dimensions for 170: 5¾" D x 20½" W x 11¼" H

<b>169</b>	Stainless Steel	1/cs	9 lb
<b>170</b> ❖	White Enamel	1/cs	9 lb

## Chrome Toilet Tissue Dispensers

**B**



**C**



- Dispenses all standard 4 ½" wide toilet tissue rolls
- Surface mounted dispensers

### **B Multi-Roll Toilet Tissue Dispenser**

- Ideal for high volume areas requiring an efficient dispenser
- Stainless steel finish enhances appearance
- Two rolls per unit reduces maintenance time and costs
- Keyed lock to reduce theft
- Dimensions: 6 ½" D x 6" W x 11 ¾" H

<b>165</b>	Stainless Steel	1/cs	5.5 lb
------------	-----------------	------	--------

### **C Chrome Single & Double Roll Dispensers**

- 18 gauge bright chrome metal finish; self-locking
- 4 ½" from the wall when loaded
- Ideal for areas requiring a heavy duty economical dispenser
- Dispenses all standard toilet tissue rolls including 4.2" x 4.5", 500 sheet rolls
- Front loading for easy service and maintenance
- Dimensions for 146: 4 ¼" D x 6" W x 2 ¾" H
- Dimensions for 150: 4 ¼" D x 11" W x 2 ¾" H

<b>146</b>	Polished Chrome	Single	20/cs	18 lb
<b>150</b>	Polished Chrome	Double	10/cs	18 lb

**D**



## 3 Roll Plastic Toilet Tissue Dispenser

### **D Tri-Roll Three Roll Standard**

- Uses any standard toilet tissue roll; 1 ½" core size
- The centre window allows you to easily check the contents of the dispenser
- Cover comes with a locking system
- A unique brake system requires complete use of each roll before rotating to the next full roll
- Dimensions: 5 ⅝" D x 11 ½" W x 11 ½" H

<b>20302</b>	Smoke	6/cs	18 lb
--------------	-------	------	-------

❖ Non-stocked item requires special order

## Metal Paper Towel Dispensers

### A Universal Towel Dispensers

- Accepts all standard single fold and roll towels, maximum 6" diameter and up to 10" long
- Front loading for easy service and maintenance
- All welded construction of 20 and 22 gauge steel
- Vinyl laminated protected saw tooth cutting edge
- Dimensions: 6¾" D x 10½" W x 9½" H
- Dimensions of 101J: 7¼ D x 10½" W x 9½" H

101	White		6/cs	30 lb
101-1	White	Locking	6/cs	30 lb
101J	White	Jumbo	6/cs	33 lb
102	❖ Chrome		6/cs	30 lb
103	❖ Stainless Steel		6/cs	30 lb

### B Control Roll Towel Dispenser

- All metal construction for areas where vandalism is a concern
- Dispenses Jumbo 8" dia. (4" reserve roll) x 8" W roll towels
- Controlled delivery through push action lever
- Keyed tumbler lock to reduce pilferage and vandalism
- Dimensions: 8¾" D x 10¾" W x 15½" H

109-50W	❖ White	with Lock	1/cs	12 lb
---------	---------	-----------	------	-------

### C Hands Free Mechanical Towel Dispenser

- Touch free dispenser will cut an 11" towel, leaving a 3" length for others to grab
- Hygienic; reduces paper flow
- Designed to dispense jumbo roll towels, with maximum 8" dia.
- Keyed tumbler lock to reduce pilferage and vandalism
- Front loading for easy service and maintenance
- Dimensions: 8¾" D x 13¾" W x 15" H

109-60W	❖ White		1/cs	12 lb
---------	---------	--	------	-------

### D Hands Free Roll Towel Dispenser

- All metal construction for areas where vandalism is a concern
- Dispenses Jumbo 8" dia. (2½" reserve roll) x 8" W roll towels
- Large detection zone senses hand to deliver a 12" length of towel; towel delivery is quiet and uniform
- Reduces paper flow and provides maximum hygiene
- Operates with 4 "D" size alkaline batteries or plug in AC adaptor
- Keyed tumbler lock to reduce pilferage and vandalism
- Dimensions: 8½" D x 11¾" W x 15¾" H

109-70W	❖ White		1/cs	15 lb
---------	---------	--	------	-------

### E Standard Roll Dispenser

- Accepts all standard 11" rolls
- All welded construction of 18 gauge steel with concealed lock
- Pivot arm hinges on hardened steel rivets
- Tension springs restrict paper consumption
- Dimensions: 4¼" D x 12¾" W x 3¾" H

126F	Polished Chrome		10/cs	32 lb
------	-----------------	--	-------	-------

## Paper Cup Dispenser

### F Water Cup Dispenser

- Self-adjusting, top loading, gravity fed dispenser
- High impact plastic in transparent white
- Wall mount for cone or flat bottom cups
- Holds cup size: cone - 3-4.5 oz; flat - 3-5 oz
- Rim size: 2¼" x 2¾"; tube length: 16"

C4160WH	Opaque White	Flip Cap	24/cs	24 lb
---------	--------------	----------	-------	-------







## Plastic Paper Dispensers

### A 9" Jr. Jumbo Tissue Dispenser

- Dispenses all universal brands of 9" tissue with cores from 3¼" - 3⅝"
- Sliding door prevents access to spare roll before first role is depleted
- Double latch key lock; durable plastic
- Dimensions: 20¼" L x 5⅝" W x 11¼" H

2529	9"	Smoke	4/cs	17 lb
------	----	-------	------	-------

### B 9" Jumbo Single Tissue Dispenser

- Dispenses all universal brands of 9" tissue with cores from 2¼" - 3⅝"
- Double latch key lock; durable plastic
- Dimensions: 11" L x 17½" W x 12¼" H

2539	9"	Smoke	6/cs	15 lb
------	----	-------	------	-------



### C Double Roll Toilet Tissue Dispenser

- Dispenses universal rolls with diameter up to 5.3" and width up to 4.5"
- Double latch key lock
- Heavy gauge metal back
- Dimensions: 6" L x 6" W x 13¼" H

2519		Smoke	6/cs	17 lb
------	--	-------	------	-------

### D Hands-Free Auto Cut Roll Towel Dispenser

- Dispenses non-perforated roll towels up to 8" (210mm) diameter and 8" wide; auto cut mechanism provides 11" sheets
- No levers, cranks or bottoms to touch, reducing the risk of cross-contamination
- Emergency paper feed assists in paper advance if needed
- No batteries required
- Made of durable, high-impact material
- Quiet operation, key lock
- Dimensions: 9" L x 12⅝" W x 14" H

5015		Smoke/Beige	1/cs	5.4 lb
------	--	-------------	------	--------



### E Combo Towel Dispenser

- Transparent plastic cover; plastic front, metal back
- Chemical-resistant, durable; key lock
- Holds 300 C-fold or 500 multi-fold towels
- Dimensions: 15¼" L x 11" W x 8¾" H

4089		Smoke	6/cs	26 lb
------	--	-------	------	-------



## Automatic Towel Dispenser

### F Automatic Paper Towel Dispenser

- Dispenses non-perforated roll towels 8" in diameter and 8" wide with cores up to 2"
- Towels dispense automatically when hands are placed in natural location under the unit
- Adjustable time delay 1, 2, or 3 seconds, sheet length 9", 12" or 15", paper saving mode 0%, 12.5%, or 2.5%
- Battery location in front of unit for easy installation
- Locking unit comes with key (4090k replacement key available)
- Low battery indicator; designed for long battery life (4 "D" size batteries, not included - see page 14)
- Dimensions: 9½" L x 11" W x 15" H

5079		Smoke	1/cs	5.4 lb
------	--	-------	------	--------

## Plastic Paper Dispensers

### A Centre Pull Towel Dispenser

- Unique self-adjusting nozzle allows reliable single sheet dispensing
- Accepts the widest range of towels
- Accommodates all center pull roll diameters
- Durable, high impact resistant plastic construction; no metal
- Dimensions: 10 1/8" Dia. x 12 1/4" H

4086	Smoke	1/cs	3.3 lb
------	-------	------	--------

### B Roll Towel Dispenser with Lever

- Dispenses non-perforated roll towels up to 8" diameter and 8" wide with core sized 1 1/2" to 2"
- Key lock; heavy gauge metal back, durable; transparent plastic cover
- Meets ADA requirements with proper installation
- Dimensions: 8 1/2" L x 10" W x 15" H

4079	Smoke	1/cs	8 lb
------	-------	------	------

### C Push Bar Roll Towel Dispenser

- Automatic transfer system for stub roll
- Handles up to 8" diameter, 8" wide roll and 4" diameter stub roll; max core 2"
- Towel cabinet features full push bar to dispense paper
- Meets ADA requirements when mounted properly
- Dimensions: 8 3/4" L x 10 1/2" W x 15 3/4" H

4099	Smoke	1/cs	7.3 lb
------	-------	------	--------



## Hand Dryers

### D Air Boss Hand Dryers

- Dries hands in 10 seconds
- Touchless - auto on/off
- Universal Voltage; flexible Mounting
- All casted metal, tamper proof cover
- Smaller dryer footprint
- Contains a single "plug and play" module replaceable in under five minutes without the need for an electrician
- 6 amp dryers use far less energy and create less noise than the competitors' models
- Up to a 97% savings on paper towel usage
- Sleek design is available in custom colours upon request
- Dimensions: 10.6" H x 6" W x 4.75" D

111WT	White	1/cs	8 lb
112BK	Black	1/cs	8 lb
113CH	Chrome	1/cs	8 lb



## Industrial Batteries

### E Energizer Industrial Batteries

- Designed for long-lasting performance for a broad range of industrial applications
- Provides longer life for a variety of dispensers, hands-free faucets, toilets and urinals

1209	H.D. 6 V Spring Bulk Battery	12/cs	14 lb
EN22	9 V Alkaline	72/cs	7.7 lb
EN91	AA Alkaline	144/cs	8.6 lb
EN92	AAA Alkaline	144/cs	4.3 lb
EN93	C Alkaline	72/cs	11.8 lb
EN95	D Alkaline	72/cs	24.3 lb





## Sanitary Napkin Receptacles & Wax Bags

### A 1102 Safe-Use® Plastic Sanitary Napkin Receptacles

- Unit empties from the bottom, so hands never touch the contents
- Prevents exposure to and the spread of disease or cross contamination
- Wall mount unit operates simply by pulling unit at bottom forward and liner automatically drops into waste receptacle for safe use action
- Can be used on floor as single or double unit
- Each unit contains complimentary waxed bag
- Dimensions: 4 $\frac{5}{8}$ " D x 9" W x 10 $\frac{5}{8}$ " H

1102WT	White	4/cs	6 lb
--------	-------	------	------

### B Sanitary Napkin Waxed Bags

- Disposable kraft waxed liners for above
- Waxed bag fits in sanitary napkin receptacles
- Prevents exposure to and spread of disease by enclosing contents
- Dimensions: 3 $\frac{1}{4}$ " D x 7 $\frac{1}{2}$ " W x 9 $\frac{1}{2}$ " H

68150	Brown	500/cs	8 lb
1101	Brown	250/cs	4.5 lb

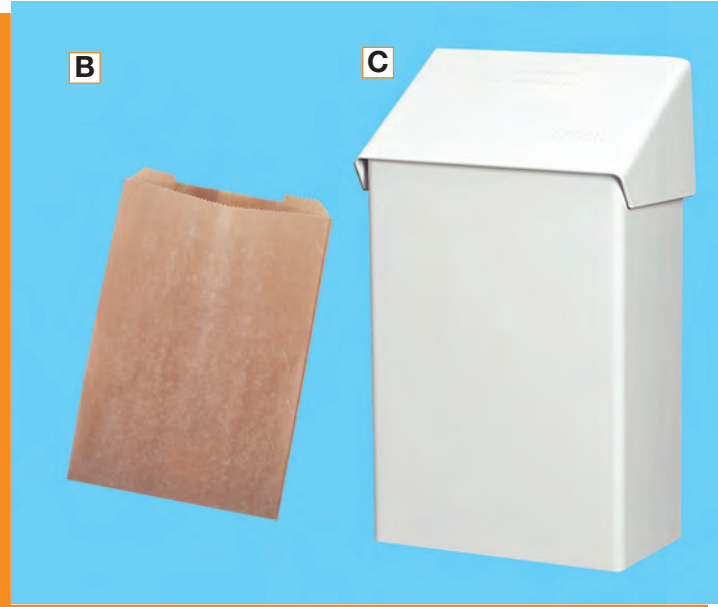

### C Metal Sanitary Napkin Receptacles

- Wall mounted
- Dimensions: 4 $\frac{1}{2}$ " D x 7 $\frac{1}{2}$ " W x 11 $\frac{1}{2}$ " H

620	White Epoxy	6/cs	23 lb
622	Stainless Steel	6/cs	23 lb

### D Sanitary Disposal System

- Hygienic, reliable sanitary disposal system
- Slim fit for easy location
- Safe, secure and convenient
- Flexible service frequency to suit your needs
- Ribbed chute helps prevent sticking
- Dimensions: 19" D x 6" W x 23" H
- Liner dimensions: 24" W x 28 $\frac{1}{2}$ " L

432WT	White	5 gal	1/cs	7 lb
432GY	Grey	5 gal	1/cs	7 lb
435	Liner	15/Roll	25 rolls/cs	11 lb



### E SaniSense Odour Neutralizer

- SaniSense automatically activates when exposed to waste material in the bin
- Large granular formulation prevents dust formation and protects service personnel from dust inhalation
- Contains Microtrans Odour Neutralizer and a high quality fragrance that eradicates bad odours and keeps bins fresh between services
- Advanced base compound penetrates dressings and releases a pervasive vapour that rises up, providing total bin coverage
- 50 metered doses of 20 g/dose per bottle

437	1000 g	12/cs	26 lb
-----	--------	-------	-------

❖ Non-stocked item requires special order

## Napkin/Tampon Dispensers

### **A** 606-1 Single Napkin Vendor

- Dispenses 16 napkins
- Surface mounted, white epoxy finish napkin dispenser
- Easy, flexible mounting on any type of wall or construction
- Removable coin box with tumbler lock
- Interchangeable coinage mechanism
- Free, 10¢, 25¢, 50¢ or \$1.00 (Loonie) vending
- Please specify mechanism required
- Dimensions: 5¾" D x 9¾" W x 25¾" H

<b>606-1</b> ♦		1/cs	20 lb
----------------	--	------	-------

### **B** 608-1 Double Napkin/Tampon Vendor

- Dispenses 16 napkins and 22 tampons
- Same features as 606-1
- Dimensions: 5¾" D x 14¾" W x 25¾" H

<b>608-1</b> ♦		1/cs	25 lb
----------------	--	------	-------



## Sanitary Napkins & Tampons

### **C** #4 Naturelle® Plus Maxi with Wings

- Features Twin Grooves System® for leak protection

<b>68001</b>		250/cs	13 lb
--------------	--	--------	-------

### **D** Naturelle® Ultra Thin Napkins

- Folded maxi with twin grooves and cloth-like cover

<b>68002</b>		200/cs	12 lb
--------------	--	--------	-------

### **E** Naturelle® Maxi

- Contoured Shape; individually wrapped

<b>Q40201</b>		250/cs	13 lb
---------------	--	--------	-------

### **F** Naturelle® Biodegradable Applicator Tampons

- Cardboard applicator

<b>68008</b>		200/cs	4 lb
--------------	--	--------	------



## Toilet Seat Cover Dispensers

### **G** Toilet Seat Cover Dispensers

- Attractive, high impact, styrene toilet seat cover dispenser
- Conveniently holds two packages of toilet seat covers (250 per package)
- Mounted by screws (included)
- Dimensions: 3¼" D x 11" W x 16" H

<b>1120</b>	White	1/cs	26 lb
-------------	-------	------	-------

### **H** Toilet Seat Covers

- Offers safe protection
- Biodegradable, half-fold style
- Dimensions: 1" D x 10½" W x 15" H

<b>1150-250</b>	White	250/pk	1.5 lb
<b>1150</b>	White, 250/pk	20 pk/cs	26 lb





**A**

Imprints Available



**B**



**C**

**D**



**E**

Imprints Available



**F**

**G**



**H**

**I**

## Bowl Mops, Brushes & Caddies

### **A** Duralon Toilet Bowl Mop

- Full 4½" mop head with greater absorbency
- Acid-resistant polypropylene strands
- 12" strong I-beam plastic handle
- Dimensions: 5¾" W x 12" H

<b>204</b>	White	100/cs	13 lb
------------	-------	--------	-------

### **B** Deluxe Cone Bowl Mop

- Heavy-duty round handle with no leak, friction-fit, self-wiping cone, acid-resistant polypropylene
- Cone slides over mop head and is squeezed
- Dimensions: 5½" Dia. x 13" L

<b>3600</b>	White	50/cs	8 lb
-------------	-------	-------	------

### **C** Deluxe Bowl Brush

- Contoured poly bristles set in sturdy plastic handle
- Bristles won't scratch, stain or absorb odours

<b>9080</b>	15½" Overall Length	24/cs	3.6 lb
-------------	---------------------	-------	--------

### **D** Standard Toilet Bowl Brush

- Cream colored tampico bristles twisted in wire
- Resists most common cleaning solvents and chemicals
- Bristle head length 6¼"

<b>220</b>	21" Overall Length	12/cs	5 lb
------------	--------------------	-------	------

### **E** Super Toilet Bowl Caddy

- Locking strap holds 32 oz bottles snugly
- Hinged lid keeps mop hidden and corrosive fumes contained; comfortable carrying handle
- Conveniently holds quart bottle and bowl mop (sold separately)
- Dimensions: 4" L x 6" W x 8" H

<b>100WH</b>	White	12/cs	4.5 lb
--------------	-------	-------	--------

<b>101BL</b>	Blue	12/cs	4.5 lb
--------------	------	-------	--------

### **F** Toilet Brush and Caddy Set

- Radial toilet brush complete with caddy

<b>123</b>	White	10/cs	5 lb
------------	-------	-------	------

### **G** Bowl Brush Caddy Only

- Optional polyethylene caddy fits all bowl brushes
- Shown with toilet bowl brush (sold separately)
- Dimensions: 4" Dia. x 4½" H

<b>123B</b>	White	100/cs	18 lb
-------------	-------	--------	-------

### **H** Pumie Toilet Bowl Ring Remover

- Powers out lime, rust and stains in toilets and urinals without harming porcelain finishes; erases toilet rings in seconds
- Ready to use; works through gentle abrasive action
- Shapes easily to flat or curved surfaces
- Safe for hands, around children and pets

<b>JAN6</b>	Display Pack of 6	1/cs	2.5 lb
-------------	-------------------	------	--------

### **I** Pumie Scouring Stick

- Cleans water stains, scale, rust and mineral deposits from urinals, sinks tubs, showers and plumbing
- Removes graffiti and paint from tile, concrete and masonry walls
- Takes off baked-on food and grease, carbon build-ups in ovens, on grills and iron cookware
- Pumie speeds the action of chemicals or works alone

<b>JAN12</b>	Display Pack of 12	Sold ea.	1.2 lb
--------------	--------------------	----------	--------

## Toilet Bowl Brushes & Mops

- All bowl brushes have a hang up hook for easy storage

### A Ergo Toilet Bowl Swab with Holder

- Ideal for daily and project cleaning
- Heads are easily replaceable with quick connect to Ergo Handle
- Apply disinfectant/bowl cleaner directly to mop or inside bowl for effective cleaning

<b>BSWHR</b>	Handle, holder 2 Mop Heads	5/cs	10 lb
<b>BSRHR</b>	Repl. Mop Head 2/pk	5 pk/cs	1.6 lb
<b>BSCOR</b>	Repl. Handle & 2 Swabs	5/cs	3.1 lb

### B Ergo Toilet Bowl Brush with Holder

- Longer, lightweight handle increases worker safety
- The holder isolates contaminants to reduce spreading
- Excess solution collects in drip bowl
- Reusable durable heads are environmentally friendly and replaceable
- Lower water line by pushing water out of trap with brush head

<b>BBWHR</b>	Brush, holder 2 Heads	5/cs	10.5 lb
<b>BBRHR</b>	Repl. Brush Head 2/pk	5 pk/cs	2.0 lb
<b>BBCOR</b>	Repl. Handle & 2 Brush Heads	5/cs	4.8 lb



## Toilet Bowl Plungers

### C Plumber One

- Safely clears obstructed and slow moving drains
- Within seconds, a controlled amount of pressure will clear difficult obstructions
- 6 applications per can make it very economical to use
- Contains no CFCs
- With the optional adapter kit, it can also be used in toilets, shower stalls, floor drains, urinals and garbage disposals

<b>17255</b>	120 g/4.5 oz Can	12/cs	6 lb
<b>17256</b>	Universal Adapter Kit	Sold ea	1 lb

### D Utility Econo Plungers

- Red rubber force cup
- Full pressure blows through clogs

<b>9074</b>	4" Cup Dia. with 9" Handle	10/cs	5 lb
<b>9075</b>	5" Cup Dia. with 9" Handle	48/cs	24 lb

### E Hydro Blast Force Cup

- Extra large engineered unique full force cup design assures instant removal of obstacles

<b>9072</b>	6" Dia. x 21" H	48/cs	48 lb
-------------	-----------------	-------	-------

### F Deluxe Professional E-Z Plunger

- Innovative bellow design provides more plunge per push
- Use to remove water from trap
- Dimensions: 6" Dia. x 21½" H

<b>9071</b>	Black	12/cs	6 lb
-------------	-------	-------	------



❖ Non-stocked item requires special order

## Touchless Fixtures



### A AutoFlush® Clamp

- AutoFlush® ensures your urinals and toilets are always flushed, odour-free and presentable
- Eliminates cross-contamination and odours
- Easy 2-minute installation with no water shut off or tools
- One unit fits both Urinal and Toilet installations
- Fits both Sloan and Zurn flush handles
- Courtesy manual flush
- 4 C-cell batteries (included) power the AutoFlush® for up to three years (80,000 flushes)
- Dimensions: 3<sup>1</sup>/<sub>6</sub>" D x 4<sup>3</sup>/<sub>4</sub>" W x 2<sup>7</sup>/<sub>8</sub>" H

401805	Chrome	6/cs	13 lb
--------	--------	------	-------

### Canadian Flush Valve Adapter Kit (for Teck, Crane or Tempus)

401973		Sold ea	0.5 lb
--------	--	---------	--------



### B AutoClean® - Urinals & Toilets

- Ensures urinals & toilets are always clean and odour-free
- Dispenses the concentrated Purinel® Cleaner
- Round-the-clock cleaning and eliminates odours
- Convenient, easy change refills
- Programmable options to meet your needs
- Normal: Dispenses Purinel® every 14 minutes,
- Lite: Dispenses Purinel® every 28 minutes,
- Heavy: Dispenses Purinel® every 7 minutes,
- Auto/24 Hr: Auto operates dispenser in selected day or night, 24 Hr operates dispenser 24 hours-a-day
- Complete system includes dispenser and connection kit, mounting hardware, two D-Cell batteries (operates one year) and stainless steel connector tube
- Dimensions: 3<sup>1</sup>/<sub>4</sub>" D x 4<sup>3</sup>/<sub>4</sub>" W x 8" H

### AutoClean Dispenser & 3/4" Saddle Kit

500409		Sold ea	3 lb
400586	Refill Purinel Concentrate Cleaner	6/cs	6 lb



### C AutoJanitor™ - Urinals & Toilets

- The AutoJanitor™ not only cleans toilets and urinals, it fragrances the restroom with clean fresh scents
- The powerful cleaning solution helps prevent stains and scaling and a quaternary agent helps reduce bacteria growth
- One dispenser can clean and deodorize up to two fixtures 24 hours a day; requires 2nd fixture tubing kit #401290
- AutoJanitor™ comes complete with dispenser, plastic tubing and mounting hardware. Batteries not included
- 3 Year Warranty against defects in parts & workmanship
- Dimensions: 3" D x 4" W x 10" H

1793506	Dispenser	6/cs	12 lb
400978	Linen Fresh (562 mL/19 oz)	6/cs	11 lb
400980	Mandarin Orange (562 mL/19 oz)	6/cs	11 lb
400982	Country Delight (562 mL/19 oz)	6/cs	11 lb
401290	2nd Fixture Tubing Kit	12/cs	5 lb

NOTE: For replacement batteries see page 14

❖ **Non-stocked item requires special order**

## Automatic Drip System

### A Odor-Guard® Drip Dispenser

- Automatically dispenses even level of odour counteractant into urinals and toilet bowls
- Easy to service and maintain; provides 24 hour protection
- Each dispenser comes complete with all hardware
- Use with 3910 Ready-To-Use Counteractant or 391B Cherry Concentrate
- Dimensions: 3½" D x 4½" W x 12" H

<b>390WT</b>	White	6/cs	12 lb
--------------	-------	------	-------

### B Odor Guard® Ready-To-Use Counteractant

- Easy to install; attach dispensing cap and place bottle in drip dispenser
- Each bottle of counteractant lasts 28-30 days; concentrate services urinal for up to 1 year
- Neutralizes urine/fecal odors at source
- Use with 390WT Odor Guard™ Drip Dispenser
- Cherry fragrance
- Dimensions: 3" D x 3½" W x 9" H

<b>3910</b>	RTU	946 mL/32 oz	6/cs	14 lb
<b>391B</b> ♦	Concentrate	961 mL/32½ oz	12/cs	30 lb



## Urinal & Toilet Mats

### C P-Shield Urinal Mat

- Absorbs and neutralizes uric acid (urine)
- An impenetrable bottom plastic layer keeps urine off the floor while a superabsorbent top layer consumes and neutralizes urine
- Reduces costs and labour by 50% — our superabsorbent soaks up at least twice as much as the leading mat
- Replacement date indicator — assures a cleaner, fresher restroom
- Unique non-slip flexible materials keep the mat where you place it
- Superabsorbent layers are black so they hide unsightly urine
- Unique, patent pending odour lock technology traps and eliminates urine and its odour
- No fragrance

<b>6PSUM</b>	Black Urinal Mat	6/cs	3 lb
--------------	------------------	------	------

### D Disposable Urinal & Toilet Floor Mats

- Orchard Zing fragrance
- Impregnated with Neutra Tech™, a neutralizing agent to combat odours and refresh the area
- Protects floors from stains and uric acid damage
- Makes restroom maintenance easier
- Improved non-slip bottom provides a safer floor surface
- Lasts 4 to 6 weeks dependent on usage

<b>1525</b>	Z-Mat Urinal Mat	6/cs	6 lb
<b>1550</b>	Toilet Mat	6/cs	5.5 lb



♦ Non-stocked item requires special order



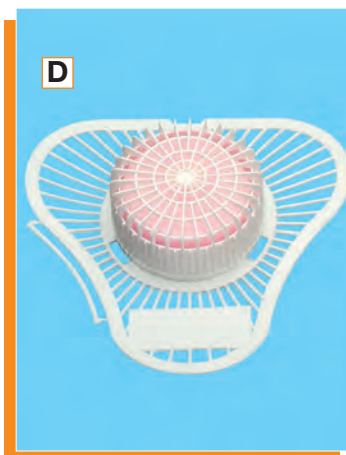

## Urinal Screens with Non-Para Block

### A Urinal Screen with (Non-Para) Block

- Cleans and deodorizes for up to 2000 flushes
- Non-para detergent block is 100% biodegradable
- Contains enzymes to reduce odours
- Cage designed to keep block above water level
- Dimensions: 7" W x 7" H

17129	4 oz	Green Apple	12/cs	4.5 lb
17135	4 oz	Cherry	12/cs	4.5 lb

### B 60 Day (Non-Para) Big Block Urinal Screen

- Lasts up to 100% longer (up to 3000 flushes)
- Non-para, water soluble block in a water soluble wrap
- Contains enzymes to reduce odors
- Cleans and deodorizes with sudsing action
- Flexible screen fits urinals of all sizes
- Built-in hook for easy removal
- Dimensions: 7" W x 7" H

94901	6 oz	Emerald Mist	6/cs	4 lb
94902	6 oz	Cherry	6/cs	4 lb

### C Urinal Screen without Blue Dye Indicator (Non-Para)

- Cleans and deodorizes for up to 1500 flushes
- Non-para, natural odor counteractant
- Patented NoRoma® enzymatic bacteria reduces odors on contact and is environmentally safe
- Strong sudsing action assures complete sanitation
- Block only is enclosed in water-soluble wrap
- Dimensions: 7" W x 7" H

9400	3 oz	Cherry	12/cs	4 lb
------	------	--------	-------	------

## Urinal Screens with Para Block

### D Urinal Screen with Para Block

- Para block deodorizes for up to 30 days
- Screen protects urinal from debris
- Dimensions: 7" W x 7" H

9513	3 oz	Cherry	12/cs	4 lb
------	------	--------	-------	------

## Urinal/Toss Blocks

### E Non-Para Urinal/Toss Blocks

- Contains enzymes to reduce odours
- Cleans and descales, biodegradable
- Lasts up to 2000 flushes

17131	4 oz	Green Apple	12/pk	12 pks/cs	36 lb
-------	------	-------------	-------	-----------	-------

### F Para Urinal Blocks - Cherry

- Practical foundation for all deodorizing systems
- Eliminates odours at their source instantly
- 3 oz and 4 oz blocks deodorize up to 30 days

21-155	3 oz	Pink	12/pk	12 pks/cs	29 lb
21-164	4 oz	White	12/pk	12 pks/cs	36 lb

❖ Non-stocked item requires special order

## Urinal Screens

### A The Wave 2.0 Urinal Screen

- Pull off the date tabs upon installation to remind you when to change the air freshener
- Includes one "Screen Saver" bag per box to store the spare screen until needed
- Freshens Urinal a full 30 Days; twice as much as the competitors
- Releases billions of optimized bacteria that clean the urinal and eliminate odours
- Longer protrusions release fragrance and reduce splashback
- Complies with VOC Requirements

20HM	Herbal Mint	10/bx	1 lb
20HS	Honeysuckle	10/bx	1 lb
20KG	Kiwi Grapefruit	10/bx	1 lb
20FB	Fabulous	10/bx	1 lb
20WG	Wintergreen	10/bx	1 lb
20OM	Ocean Mist	10/bx	1 lb
20MG	Mango	10/bx	1 lb
20CT	Citrus	10/bx	1 lb
20SA	Spiced Apple	10/bx	1 lb
20CB	Cotton Blossom	10/bx	1 lb
20GP	Guava Pineapple	10/bx	1 lb
20CM	Cucumber Melon	10/bx	1 lb

### B The Dome Urinal Screen

- Fragrances last 60 days; purchase 50% fewer screens
- Date tabs remind you when to change it
- Non-splash dome design minimizes over-spray on floors walls and partitions
- Perfect for high domed waterless urinal cartridges and raised drains; eliminates floating and movement in the urinal
- Contains billions of beneficial bacteria that consume the source of drain odours

RUS30HM	Herbal Mint	5/bx	1.4 lb
RUS30FB	Fabulous	5/bx	1.4 lb
RUS30MG	Mango	5/bx	1.4 lb
RUS30CT	Citrus	5/bx	1.4 lb
RUS30SA	Spiced Apple	5/bx	1.4 lb
RUS30CB	Cotton Blossom	5/bx	1.4 lb
RUS30CM	Cucumber Melon	5/bx	1.4 lb

### C Deluxe Deodorizing Urinal Screens

- One size fits most urinals; individually wrapped
- Variety of fragrances and colours
- Built-in germ fighting ingredients
- Dimensions: 8" W x 8" H

1451	Red/Cherry	50/cs	10 lb
1452	Blue/Bubble Gum	50/cs	10 lb

### D Sweet Pea Urinal Screens

- Built-in germ fighting ingredients; individually wrapped
- One size fits most urinals; prevents clogged drains
- Dimensions: 8" W x 8" H

9306	Blue/Cherry	50/cs	10 lb
------	-------------	-------	-------

### E Urinal Screen with Block Holder

- Not affected by harsh chemicals
- One size fits most urinals; prevents clogged drains
- Dimensions: 8" W x 9" H

501	Blue	50/cs	8 lb
-----	------	-------	------

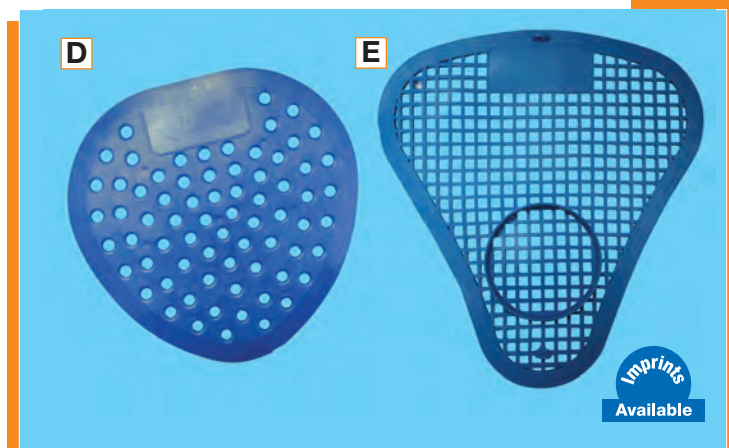
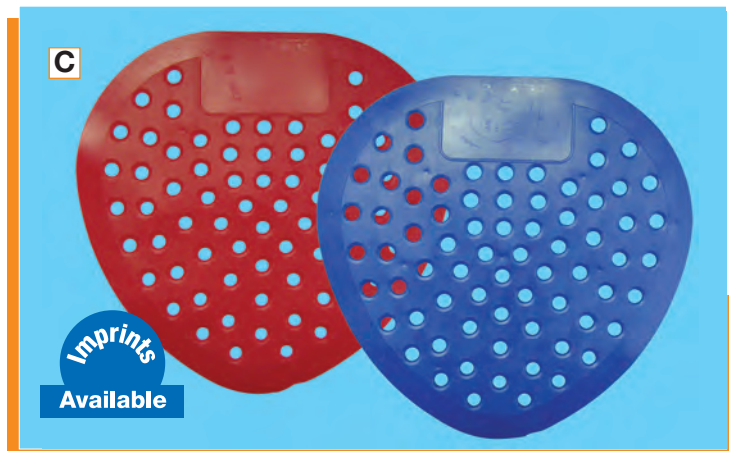
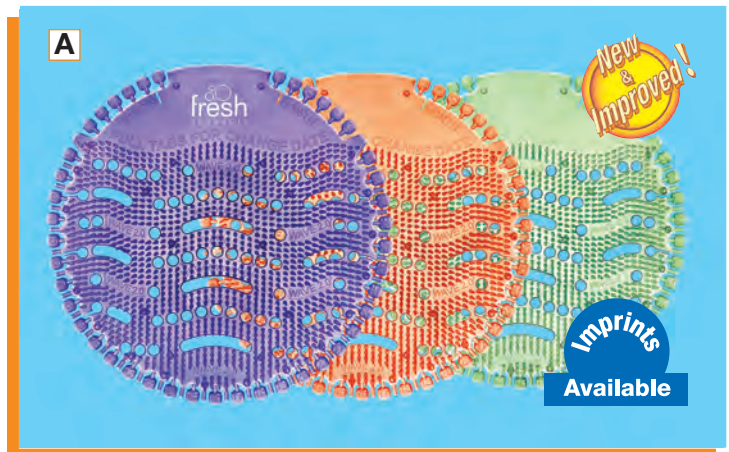



## Fixture Odour Control

### A Eco Clip

- Freshens the air for 30 days or more
- Unique patent-pending material contains 30 times more air freshener than standard rim sticks
- Environmentally Friendly; low VOC's
- 100% recyclable; will not dissolve in or pollute water
- Fits most standard toilets; clips on outside of bowl
- Also clips on toilet tank, bathroom partition, etc.

<b>EBC72HM</b>	Herbal Mint	12/cs	1.6 lb
<b>EBC72HS</b> ♦	Honeysuckle	12/cs	1.6 lb
<b>EBC72KG</b> ♦	Kiwi Grapefruit	12/cs	1.6 lb
<b>EBC72FB</b> ♦	Fabulous	12/cs	1.6 lb
<b>EBC72OM</b> ♦	Ocean Mist	12/cs	1.6 lb
<b>EBC72MG</b>	Mango	12/cs	1.6 lb
<b>EBC72CT</b> ♦	Citrus	12/cs	1.6 lb
<b>EBC72SA</b>	Spiced Apple	12/cs	1.6 lb
<b>EBC72CB</b>	Cotton Blossom	12/cs	1.6 lb
<b>EBC72GP</b> ♦	Guava Pineapple	12/cs	1.6 lb
<b>EBC72CM</b>	Cucumber Melon	12/cs	1.6 lb



## In Tank Cleaners

### B Ultra Big Blue Automatic Toilet Bowl Cleaner

- Terrific maintenance in-tank cleaner
- Cleans, deodorizes and blues the water
- Prevents scale build up, saving cleaning time and money
- Contains enzymes that break down organic matter, eliminating odours
- Lasts up to 900 flushes
- Environmentally friendly formula

<b>17179</b>	9 oz	12/cs	8 lb
--------------	------	-------	------



### C In-Tank Drop-In Blocks

- Convenient to use; just drop in the back of the toilet
- No plastic or glass containers to remove
- Long lasting freshness
- Lasts up to 1,200 flushes

<b>24DI</b>	2 oz	Blue	24/bx	4.3 lb
-------------	------	------	-------	--------

### D Rim Cage (Non-Para)

- Super Dual Action Cleans and Freshens with each flush
- Lasts up to 30 days; fits over the rim of most toilets
- "Blue Bubble" formulation turns the water blue with every flush
- Contains no Para or Chlorine
- Fights rings and stains
- Dimensions: 1¾" Dia. x 2¾" W

<b>17130</b>	Green Apple	24/cs	5 lb
--------------	-------------	-------	------

♦ Non-stocked item requires special order

## Deodorant Blocks & Air Freshener Cabinets

### A Metal Deodorant Wall Cabinet

- Chrome plated 20 gauge steel surface mounted fixture
- Holds all standard size deodorant blocks
- Non-motorized
- Dimensions: 2½" D x 3½" W x 9" H

1100	Chrome	20/cs	20 lb
------	--------	-------	-------

### B Para Wall Blocks Cherry

- 16 oz and 24 oz blocks control odours up to 60 days
- The perfect complement to urinal and toilet bowl blocks

21-111	White 16 oz	12/bx	12 lb
21-116	Pink 24 oz	12/bx	18 lb

### C Para 20 lb Super Blocks Cherry

- Perfect deodorant powerhouse for sewers, elevator shafts, dumpster areas, garbage areas
- Fights odours up to 14 weeks
- Unique mesh hanger, safe for easy hanging

1-20	Cherry	2/cs	40.5 lb
------	--------	------	---------

### D Non-Para Fragrance Super Blocks

- Great deodorizer for sewers, elevator shafts, dumpster areas, garbage collection areas, water treatment facilities, etc.
- FSB5 block lasts 4 months and FSB7 block lasts 6 months
- 100% fragrance; no VOC's

FSB5	5 lb	Black Cherry	4/cs	25 lb
FSB7	7 lb	Black Cherry	4/cs	33 lb

### E Air Freshener Cabinet

- Room deodorizing, operates continuously
- Most effective room size: 10' x 10' x 10'
- Accommodates 30 day cartridges
- Dimensions: 3½" L x 3¼" W x 7¾" D

350WT	White	12/cs	10 lb
348	Grey	12/cs	10 lb

### F 30-Day Fragrance Cartridge

- Uniform release of natural fragrance for 30 days
- Batteries included, Dimensions: 3½" D x 2 ¾" H
- Quick and easy replacement of the cartridge & battery

354C	Cherry	6/cs	3 lb
358P	Paradise	6/cs	3 lb
361B	Ocean Breeze	6/cs	3 lb
363O	Orange Burst	6/cs	3 lb

◆ Non-stocked item requires special order

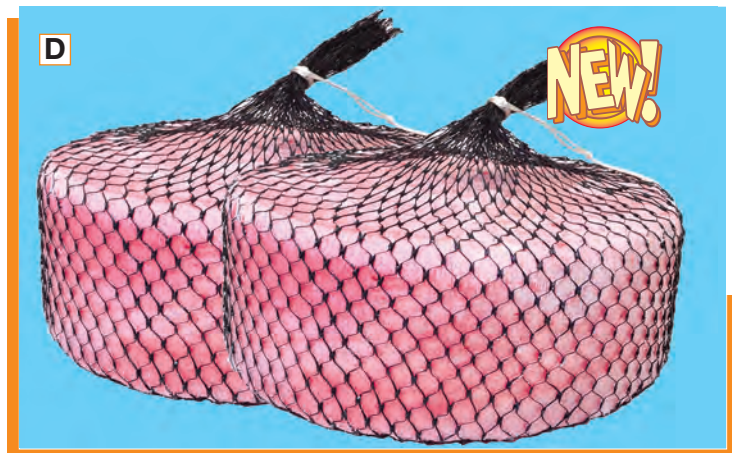

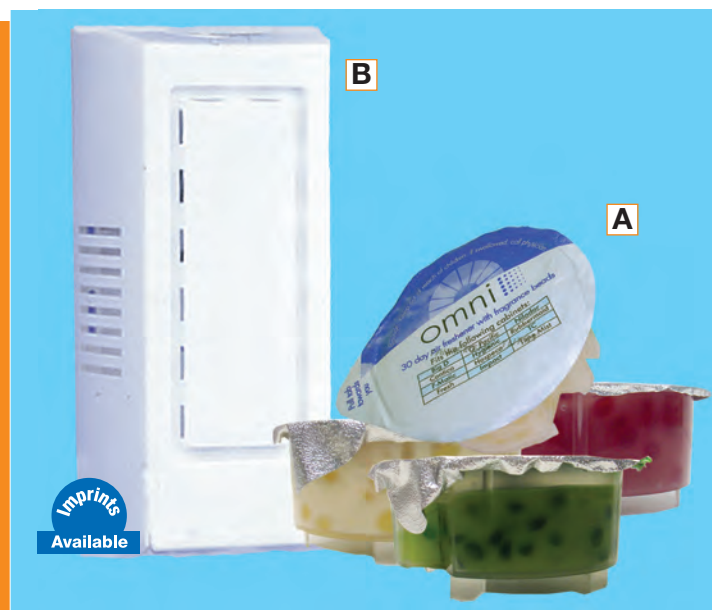

## Odour Control

### A Omni Gels

- 30-day gel air freshener
- Fragrance bead technology enhances overall gel performance and longevity
- Patented gel technology evaporates revealing the beads and releasing a burst of air freshening power
- Water soluble, non-toxic, non-flammable formula
- Fits the 300 Still Super Deodorant Wall Cabinet and at least 12 major competitors' cabinets, including Big D, Continental, Hospeco, Impact, Rubbermaid, etc.

OMNICF	2 oz	Cherry	12/cs	4 lb
OMNITTF	2 oz	Tangerine Twist	12/cs	4 lb
OMNISF	2 oz	Springtime	12/cs	4 lb

### B Still Super Deodorant Wall Cabinet

- Non-motorized with unique living hinge & locking device
- Durable 100% polypropylene; will not rust or corrode
- Accommodates many gels, liquids, deodorants and 16 oz and 24 oz deodorant blocks
- More venting for improved air circulation
- Individually polybagged with mounting screws and tape
- Dimensions: 3 3/8" D x 4" W x 8 3/4" H

300	White	12/cs	6.5 lb
-----	-------	-------	--------

NOTE: For deodorant blocks, see page 24



### C TCell™ Continuous Odor Control System

- Patented fuel cell creates hydrogen in the formula chamber forcing an equal amount of odour neutralizer out of the chamber
- Consistent dosing over 60 - 90 days
- Contains Microtrans®, a true odour neutralizer
- No batteries required; no programming
- Tamper resistant; compact with silent operation

1793546	Black	Dispenser	12/cs	1.5 lb
1793547	White	Dispenser	12/cs	1.5 lb
1793548	Chrome	Dispenser	12/cs	1.5 lb
402113	Citrus Refill		6/cs	2 lb
402498	Pure Odor Neutralizer		6/cs	2 lb
1836258	Energizing Spa Refill		6/cs	2 lb
402369	Mango Blossom Refill		6/cs	2 lb
402470	Cucumber Melon Refill		6/cs	2 lb
402187	Crystal Breeze Refill		6/cs	2 lb



### D Eco Air Passive 30-Day Air Freshener

- Fits TC®, TimeMist®, Ecolab®, Hospeco®, Kimberly-Clark®, Vectair® and fan dispensers too
- Cannot spill or break; 100% recyclable
- Use in restroom stalls, on restroom walls, conference rooms, entry ways, lobbies, trash rooms and near soiled linens

EA36HM	Herbal Mint	6/cs	1.3 lb
EA36KG	Kiwi Grapefruit	6/cs	1.3 lb
EA36FB	Fabulous	6/cs	1.3 lb
EA36MG	Mango	6/cs	1.3 lb
EA36CT	Citrus	6/cs	1.3 lb
EA36SA	Spiced Apple	6/cs	1.3 lb
EA36CB	Cotton Blossom	6/cs	1.3 lb
EA36CM	Cucumber Melon	6/cs	1.3 lb
EACAB2	Eco Air Cabinet	12/cs	2.0 lb

## Odour Control

### A Eco Fresh Hang Tags

- 100% more fragrance than typical air fresheners
- Versatile - hang it in places like a stall doorstop, toilet handle, fan cabinets, etc.
- Environmentally friendly when compared to most gel or metered aerosol air fresheners

<b>72HM</b>	Herbal Mint	12/cs	1.7 lb
<b>72HS</b>	Honeysuckle	12/cs	1.7 lb
<b>72KG</b> ♦	Kiwi Grapefruit	12/cs	1.7 lb
<b>72WG</b>	Wintergreen	12/cs	1.7 lb
<b>72OM</b> ♦	Ocean Mist	12/cs	1.7 lb
<b>72MG</b>	Mango	12/cs	1.7 lb
<b>72CT</b> ♦	Citrus	12/cs	1.7 lb
<b>72SA</b>	Spiced Apple	12/cs	1.7 lb
<b>72CB</b>	Cotton Blossom	12/cs	1.7 lb
<b>72GP</b> ♦	Guava Pineapple	12/cs	1.7 lb
<b>72CM</b> ♦	Cucumber Melon	12/cs	1.7 lb
<b>I114</b>	Suction Cups	12/bg	0.1 lb



### B Easy Fresh

- The only air freshener that uses the cover of the dispenser as the air freshener itself; no locks - remove the old cover and replace it
- Powerful enough to freshen large areas; contains 2 - 3 times more fragrance than most gels or metered aerosols
- VOC compliant and works continuously; no peaks of freshness
- Air freshener lasts consistently for 30 days or more
- The computerized fan turns sparingly in week 1 and gradually turns more frequently until week 4 when the fan turns constantly
- Refills available with and without batteries
- See page 3 for complete list of available fragrances with code numbers

#### Dispensers

<b>EFCABP</b>	Passive Dispenser	24/cs	0.8 lb
<b>EFCABPE</b>	Fan Dispenser	12/cs	4 lb



## Baby Change Station

### C Baby Care Station

- Sturdy safety strap, deep concave bed and side walls provide a safe surface for changing; holds up to 250 lb
- Non-porous, high-density polyethylene is easy to keep sanitary and will not absorb moisture or odors
- Smooth surfaces, oversized hinge, tamper-proof hardware and safety stop system provide added child security
- Built-in dispenser accepts narrow, multi-fold liners
- Contoured bag hooks to hang purse and diaper bag
- Several multilingual instructions
- Four inch depth complies with ADA and ANSI A117.1 handicapped accessibility
- Dimensions (folded): 4" D x 34¼" W x 18" H

<b>8252H</b>	White	1/cs	16 lb
<b>8255</b>	Change Station Liners	500/cs	8 lb





## Swing Top Waste Receptacles

- 22 gauge cold rolled steel construction offers maximum fire protection with no openings on sides or bottom of unit
- All units include a standard bag holder apparatus

### Free Standing Swing Top Receptacles

- Rounded soft edge design; recessed feet elevate the unit
- Small and medium units fit under most counter tops

#### A White Epoxy Finish

- Finished in hybrid epoxy polyester powder coat paint and black vinyl trim
- Dimensions for 300NL: 14 $\frac{3}{4}$ " D x 13 $\frac{3}{4}$ " W x 42" H
- Dimensions for 301NL: 14 $\frac{3}{4}$ " D x 13 $\frac{3}{4}$ " W x 34 $\frac{3}{4}$ " H
- Dimensions for 302NL: 14 $\frac{3}{4}$ " D x 13 $\frac{3}{4}$ " W x 26 $\frac{3}{4}$ " H

<b>300NL</b>	White	105 L/23 Imp gal	1/cs	27 lb
<b>301NL</b>	White	80 L/17.5 Imp gal	1/cs	23 lb
<b>302NL</b>	White	55 L/12 Imp gal	1/cs	19 lb

#### B Stainless Steel Finish

- Dimensions: 14 $\frac{3}{4}$ " D x 13 $\frac{3}{4}$ " W x 34 $\frac{3}{4}$ " H

<b>301NLS</b> ♦	SS	80 L/17.5 Imp gal	1/cs	23 lb
-----------------	----	-------------------	------	-------

#### C Wall Mounted Swing Top Receptacles

- White epoxy finish with black vinyl trim

##### Standard Wall Mounted Receptacle

- Designed to conserve floor space in light to medium-duty areas
- Dimensions: 8" D x 15 $\frac{3}{4}$ " W x 33" H

<b>303NL</b>	White	50 L/11 Imp gal	1/cs	20 lb
<b>303-3NL</b> ♦	SS	50 L/11 Imp gal	1/cs	20 lb

##### Jumbo Wall Mounted Receptacle

- Designed to conserve floor space in medium to heavy-duty areas; trash bag replaces optional metal liner (not available)
- Dimensions: 8" D x 21 $\frac{3}{4}$ " W x 39" H

<b>304NL</b> ♦	White	77 L/17 Imp gal	1/cs	27 lb
----------------	-------	-----------------	------	-------

### Optional Galvanized Metal Liners

- Optional light weight 26 gauge galvanized steel liner

<b>300-500</b> ♦	Fits 300NL	Sold ea.	13 lb
<b>301-500</b> ♦	Fits 301NL & 301NLS	Sold ea.	12 lb
<b>302-500</b> ♦	Fits 302NL	Sold ea.	6 lb
<b>303-500</b> ♦	Fits 303NL	Sold ea.	7 lb

## Free Standing Waste Receptacles

#### D Free Standing Funnel Top

- Dimensions: 18" Dia. x 30" H
- Dimensions 310J: 21 $\frac{1}{2}$ " Dia. x 35 $\frac{1}{2}$ " H
- 8" diameter top inlet waste opening
- Brushed Stainless Steel Finish

<b>310S</b>	121 L/ 27.5 Imp. gal	1/cs	43 lb
<b>310J</b> ♦	206 L/ 45 Imp. gal	1/cs	30 lb

♦ Non-stocked item requires special order



# Floor & Wall Maintenance





## Advantage Conventional Thick Line Pads

- Tough, long lasting pads for every floor maintenance job
- Designed and produced to give superior performance on specific floor surfaces
- Use wet or dry with conventional or high speed machines
- Institutional, commercial or industrial applications
- All pads are a blend of 100% virgin polyester and/or 100% virgin nylon fibres bonded with a tough, strong, elastic synthetic resin and impregnated with abrasives
- The specific types of fibres and abrasives used are related to the aggressiveness required for the particular floor maintenance procedure
- Each pad is designed for continuous contact with floor surface
- Open web construction enables easier dirt pick-up
- All pads are usable on both sides with equal effectiveness
- Centre hole punch-out plug

### **A Black - stripping**

For long lasting, heavy-duty stripping

### **B Brown - high productivity**

For fast, uniform stripping, wet or dry

### **C Green - scrubbing**

Wet, heavy-duty scrubbing

### **D Blue - cleaner**

Wet, medium duty scrubbing

### **E Red - buffing**

For dry buffing, spray buffing or light duty scrubbing

### **F Tan - buffing**

For light cleaning and dry buffing

### **G White - super polish**

For dry polishing or with fine water mist to ensure high gloss

Size	Black	Brown	Green	Blue	Red	Tan	White	Cs Qty.	lb
10" ♦	A06-10	A08-10 ♦	A02-10	A15-10	A05-10	A75-10 ♦	A01-10 ♦	5	1.0
11" ♦	A06-11	A08-11 ♦	A02-11	A15-11	A05-11	A75-11 ♦	A01-11	5	1.0
12" ♦	A06-12	A08-12 ♦	A02-12	A15-12	A05-12	A75-12 ♦	A01-12	5	1.0
13" ♦	A06-13	A08-13 ♦	A02-13	A15-13	A05-13	A75-13 ♦	A01-13	5	1.5
14" ♦	A06-14	A08-14 ♦	A02-14	A15-14	A05-14	A75-14 ♦	A01-14	5	2.0
15" ♦	A06-15	A08-15 ♦	A02-15	A15-15	A05-15	A75-15 ♦	A01-15	5	2.0
16" ♦	A06-16	A08-16 ♦	A02-16	A15-16	A05-16	A75-16 ♦	A01-16	5	2.5
17"	A06-17	A08-17 ♦	A02-17	A15-17	A05-17	A75-17 ♦	A01-17	5	2.5
18"	A06-18	A08-18 ♦	A02-18	A15-18	A05-18	A75-18 ♦	A01-18	5	3.0
19"	A06-19	A08-19 ♦	A02-19	A15-19	A05-19	A75-19 ♦	A01-19	5	3.0
20"	A06-20	A08-20 ♦	A02-20	A15-20	A05-20	A75-20 ♦	A01-20	5	3.5
21" ♦	A06-21	A08-21 ♦	A02-21	A15-21	A05-21	A75-21 ♦	A01-21	5	4.0

♦ Non-stocked item requires special order

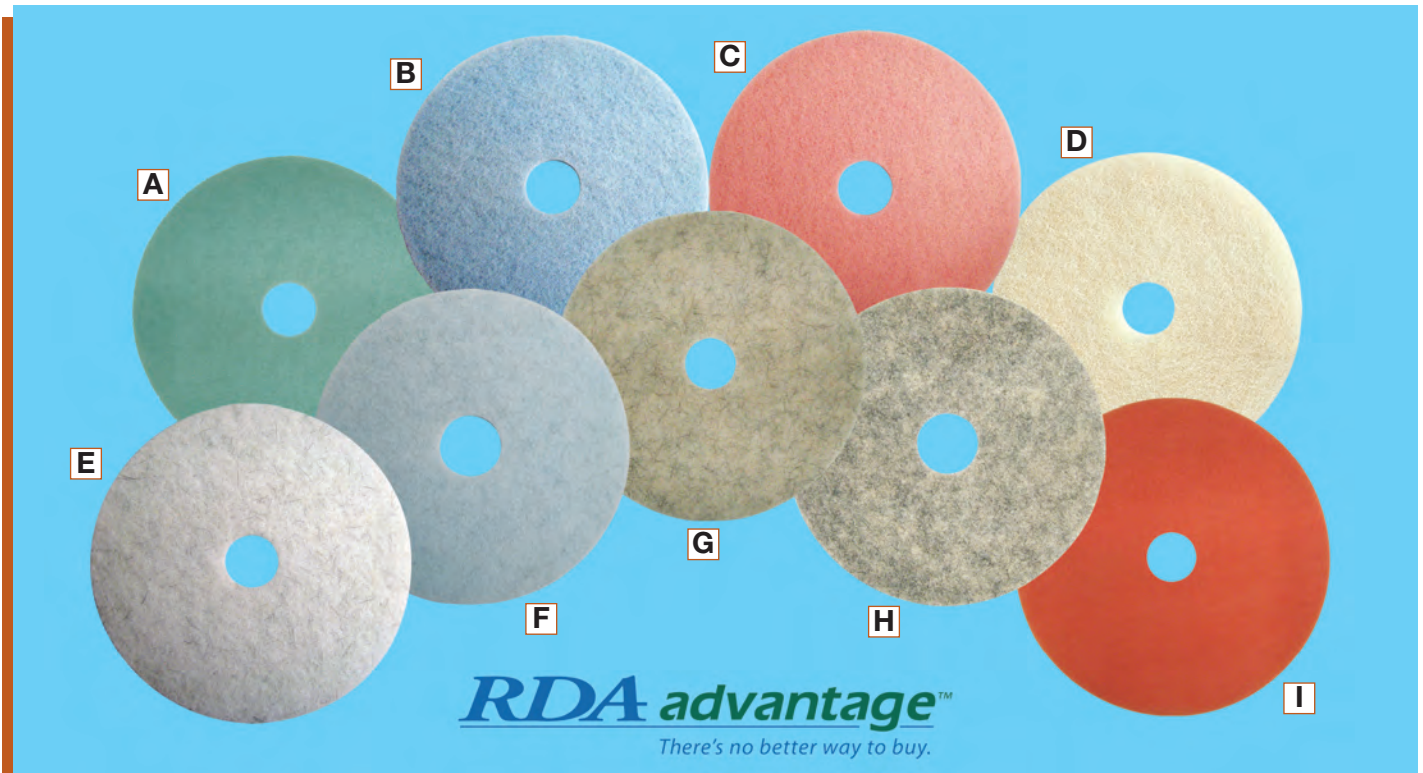

## Ultra High Speed Pads

- Various types of floor pads for every floor surface and preparation procedure
- A selection from the pads above will produce and maintain the wet-look shine on various floor surfaces when used with the different types of finishes and machines
- Centre hole punch-out plug or with optional ▼ bolt hole for high speed machines



- Octagon floor pads available upon request; contact your rep for details

- A Aqua - Burnishing (best used on machines up to 3000 RPM)**  
Thick, soft pads to lightly polish softer floor finishes; ideal for top dressing to a reflective gloss
- B Blue Velvet - Burnishing (best used on machines up to 3000 RPM)**  
Removes black marks without removing finish; great for laying a high-gloss finish in heavy traffic areas
- C Pink Burnish - Burnishing (best used on machines up to 3000 RPM)**  
Restores finish, improves gloss on harder floor surfaces; removes marks and scuffs quickly
- D Beige Polythermal - Burnishing (best used on machines up to 3000 RPM)**  
Stands up to propane burnishing; yields very, very high-gloss finishes on soft/medium surfaces
- E Hair Blend Light - Burnishing (best used on machines up to 3000 RPM)**  
Controlled blend of polyester and natural hair fibres; yields a "wet look" finish
- F Blue Natural Hair - Burnishing (best used on machines up to 3000 RPM)**  
Blend of blue polyester and natural hair fibres; produces the wet look on soft/medium finishes
- G Hair Blend Medium - Burnishing (best used on machines up to 1500 - 3000 RPM)**  
Aggressive, heavy blend of natural hair and polyester fibers; best suited for medium/hard finishes
- H Hair Blend Heavy - Burnishing (best used on machines up to 3000 RPM)**  
The most aggressive Burnishing Pad available; provides a "wet-look" shine
- I Peach - Burnishing, HS, Auto Scrubbing (best used on machines up to 1500 RPM)**  
Use on all types of floor finishes; use with an Auto Scrubber, for daily HS work or spray buffing

Size	Aqua A	Blue Velvet B	Pink C	Beige D	Hair Blend Light E	Blue Hair Blend F	Hair Blend Medium G	Hair Blend Heavy H	Peach I	Case Qty.	lb
19"	A30-19 ♦	A040-19	A76-19	A16-19 ♦	A21-19	A19-19 ♦	A20-19	A22-19	A23-19 ♦	5	3
20"	A30-20 ♦	A040-20	A76-20 ♦	A16-20 ♦	A21-20	A19-20 ♦	A20-20	A22-20	A23-20 ♦	5	3
21"	A30-21 ♦	A040-21	A76-21 ♦	A16-21 ♦	A21-21 ♦	A19-21 ♦	A20-21	A22-21	A23-21 ♦	5	4
22"	A30-22 ♦	A040-22	A76-22 ♦	A16-22 ♦	A21-22 ♦	A19-22 ♦	A20-22 ♦	A22-22 ♦	A23-22 ♦	5	4
24"	A30-24 ♦	A040-24	A76-24 ♦	A16-24 ♦	A21-24	A19-24 ♦	A20-24	A22-24 ♦	A23-24 ♦	5	5
27" ▼	A30-27 ♦	A040-27 ♦	A76-27 ♦	A16-27 ♦	A21-27 ♦	A19-27 ♦	A20-27 ♦	A22-27 ♦	A23-27 ♦	2	3



## Rectangular Floor Pads

### A Rectangular Floor Pads

- These pads are built to perform at a high level when used with the action of orbital machines
- Available in White for Polishing, Red for Buffing, Blue for Cleaning, Green for Scrubbing, Black for Stripping and Maroon Thin Line for surface conditioning/stripping
- Rectangular floor pads are available in White for polishing, Red for buffing, Blue for cleaning, Green for scrubbing, Black for stripping and in the Thin Maroon for surface conditioning/stripping work

4112-18	◆	White	12" x 18"	5/cs	1.4 lb
4114-20	◆	White	14" x 20"	5/cs	2.8 lb
4114-28	◆	White	14" x 28"	5/cs	3.7 lb
4114-32	◆	White	14" x 32"	5/cs	4.0 lb
5112-18	◆	Red	12" x 18"	5/cs	1.6 lb
5114-20	◆	Red	14" x 20"	5/cs	3.1 lb
5114-28	◆	Red	14" x 28"	5/cs	4.2 lb
5114-32	◆	Red	14" x 32"	5/cs	4.5 lb
5312-18	◆	Blue	12" x 18"	5/cs	1.7 lb
5314-20	◆	Blue	14" x 20"	5/cs	3.2 lb
5314-28	◆	Blue	14" x 28"	5/cs	6.2 lb
5314-32	◆	Blue	14" x 32"	5/cs	5.7 lb
5512-18	◆	Green	12" x 18"	5/cs	1.9 lb
5514-20	◆	Green	14" x 20"	5/cs	4.0 lb
5514-28	◆	Green	14" x 28"	5/cs	5.4 lb
5514-32	◆	Green	14" x 32"	5/cs	5.9 lb
7212-18	◆	Black	12" x 18"	5/cs	2.2 lb
7214-20	◆	Black	14" x 20"	5/cs	4.8 lb
7214-28	◆	Black	14" x 28"	5/cs	6.5 lb
7214-32	◆	Black	14" x 32"	5/cs	7.2 lb
4712-18	◆	Maroon	12" x 18"	10/cs	2.2 lb
4714-20	◆	Maroon	14" x 20"	10/cs	4.7 lb
4714-28	◆	Maroon	14" x 28"	10/cs	6.3 lb
4714-32	◆	Maroon	14" x 32"	10/cs	7.0 lb

### B Diamond Rectangular Pads

- Polish the floors mechanically instead of using chemicals
- Give life to dull, worn out floors transforming them to clean, glossy and brightly polished floors
- Wear indicators indicate when to replace the pad
- Use on concrete, granite, limestone, marble, cement-based terrazzo, travertine, VCT
- Produced with recycled fibre materials, Cyclone-D™ Diamond Floor Pads are environmentally friendly and cost effective

400-1420	◆	400 grit	14" x 20"	2/cs	1.6 lb
400-1428	◆	400 grit	14" x 28"	2/cs	2.1 lb
400-1432	◆	400 grit	14" x 32"	2/cs	3.1 lb
800-1420	◆	800 grit	14" x 20"	2/cs	1.6 lb
800-1428	◆	800 grit	14" x 28"	2/cs	2.1 lb
800-1432	◆	800 grit	14" x 32"	2/cs	3.1 lb
1500-1420	◆	1500 grit	14" x 20"	2/cs	1.6 lb
1500-1428	◆	1500 grit	14" x 28"	2/cs	2.1 lb
1500-1432	◆	1500 grit	14" x 32"	2/cs	3.1 lb
3000-1420	◆	3000 grit	14" x 20"	2/cs	1.6 lb
3000-1428	◆	3000 grit	14" x 28"	2/cs	2.1 lb
3000-1432	◆	3000 grit	14" x 32"	2/cs	3.1 lb

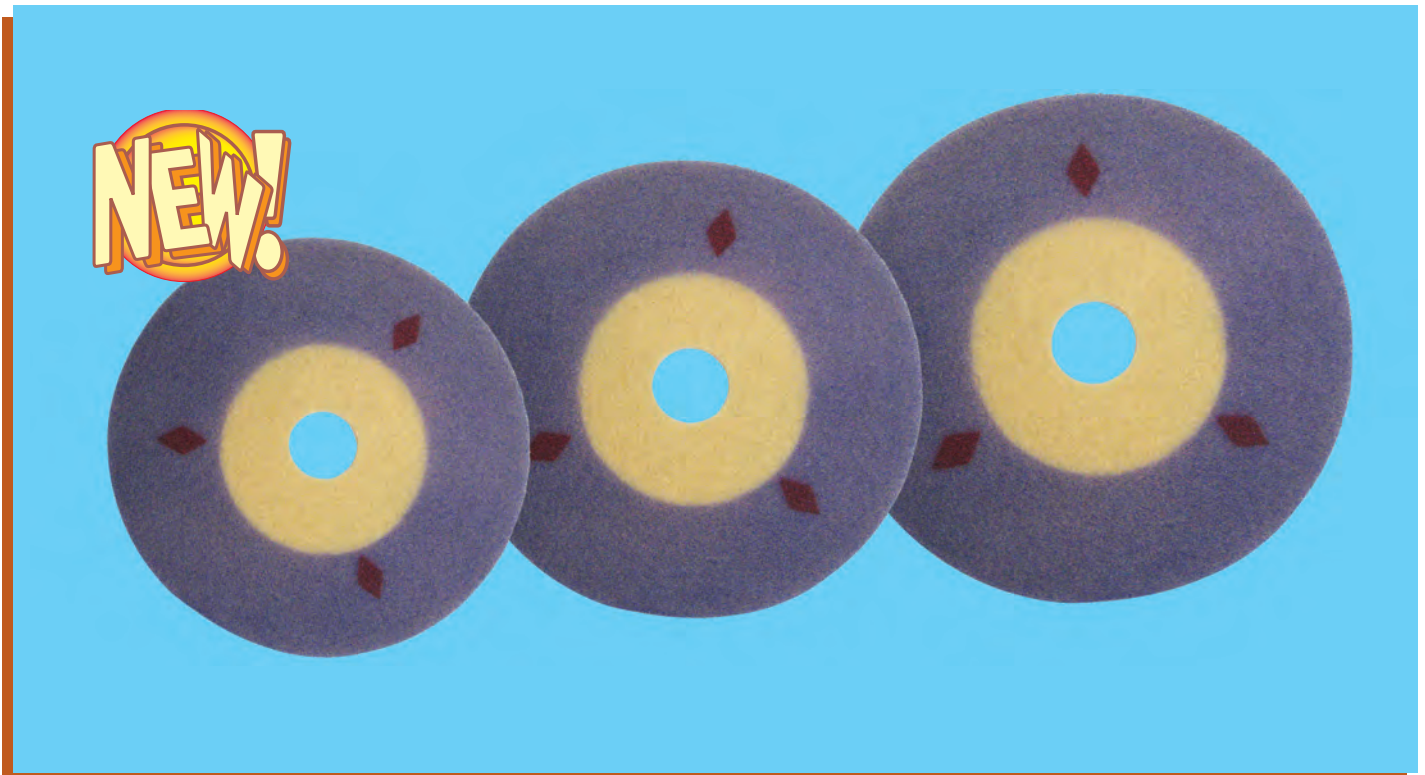

## Cyclone-D™ Diamond Floor Pads

- Diamond Floor Pads yield better results with less labour
- Use for daily maintenance with existing equipment
- Polish the floor mechanically instead of using chemicals
- Pads will give life to dull, worn out floors transforming them to clean, glossy and brightly polished floors
- Wear indicators make it easy to determine when to replace the pad
- Use on concrete, granite, limestone, marble, cement-based terrazzo, travertine, VCT
- Produced with recycled fibre materials, Cyclone-D™ Diamond Floor Pads are environmentally friendly and cost effective

Size	400 Grit	800 Grit	1500 Grit	3000 Grit	Cs Qty.	lb
8"	4008 ♦	8008 ♦	15008 ♦	30008 ♦	2/cs	0.8 lb
10"	40010 ♦	80010 ♦	150010 ♦	300010 ♦	2/cs	0.9 lb
11"	40011 ♦	80011 ♦	150011 ♦	300011 ♦	2/cs	1.0 lb
12"	40012 ♦	80012 ♦	150012 ♦	300012 ♦	2/cs	1.0 lb
13"	40013 ♦	80013 ♦	150013 ♦	300013 ♦	2/cs	1.1 lb
14"	40014 ♦	80014 ♦	150014 ♦	300014 ♦	2/cs	1.3 lb
15"	40015 ♦	80015 ♦	150015 ♦	300015 ♦	2/cs	1.3 lb
16"	40016 ♦	80016 ♦	150016 ♦	300016 ♦	2/cs	1.5 lb
17"	40017 ♦	80017 ♦	150017 ♦	300017 ♦	2/cs	1.6 lb
18"	40018 ♦	80018 ♦	150018 ♦	300018 ♦	2/cs	1.8 lb
19"	40019 ♦	80019 ♦	150019 ♦	300019 ♦	2/cs	1.9 lb
20"	40020 ♦	80020 ♦	150020 ♦	300020 ♦	2/cs	2.2 lb
21"	40021 ♦	80021 ♦	150021 ♦	300021 ♦	2/cs	2.3 lb
24"	40024 ♦	80024 ♦	150024 ♦	300024 ♦	2/cs	3.2 lb
27"	40027 ♦	80027 ♦	150027 ♦	300027 ♦	2/cs	3.3 lb
28"	40028 ♦	80028 ♦	150028 ♦	300028 ♦	2/cs	3.4 lb

♦ Non-stocked item requires special order

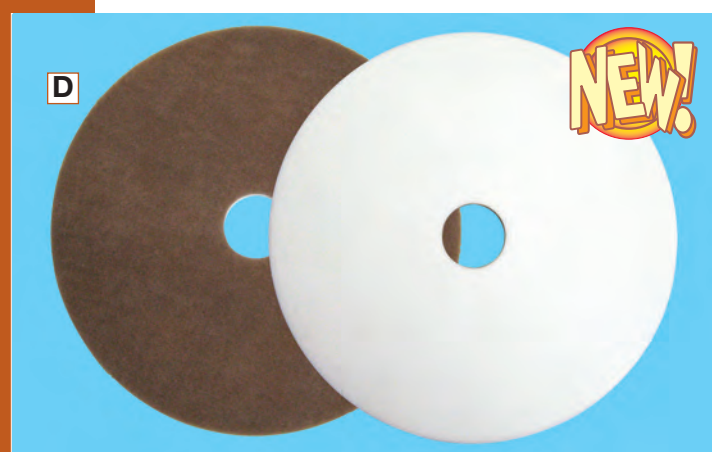

## Specialty Floor Pads

### A Emerald Hy-Pro

- Maximum abrasive content, tear resistant and long wearing
- 5/8" thick; it's the toughest pad
- Wide open mesh construction allows solutions to flow through without build-up

A66-17	17"	Emerald Hy-Pro	5/cs	3.0 lb
A66-18	18"	Emerald Hy-Pro	5/cs	3.0 lb
A66-19	19"	Emerald Hy-Pro	5/cs	5.0 lb
A66-20	20"	Emerald Hy-Pro	5/cs	5.4 lb

### B Midnight Blue Super Strip Floor Pad

- Highly abrasive and tear resistant with heavy duty stripping power; unique fibre blend for durability
- Open weave design allows flow-through without build up and loading

A62-11	◆	11"	Midnight Blue	5/cs	2.1 lb
A62-12	◆	12"	Midnight Blue	5/cs	2.3 lb
A62-13	◆	13"	Midnight Blue	5/cs	2.6 lb
A62-14	◆	14"	Midnight Blue	5/cs	2.8 lb
A62-15	◆	15"	Midnight Blue	5/cs	3.2 lb
A62-16	◆	16"	Midnight Blue	5/cs	3.5 lb
A62-17		17"	Midnight Blue	5/cs	4.0 lb
A62-18		18"	Midnight Blue	5/cs	4.4 lb
A62-19		19"	Midnight Blue	5/cs	5.0 lb
A62-20		20"	Midnight Blue	5/cs	5.4 lb
A62-21	◆	21"	Midnight Blue	5/cs	6.2 lb

### C Maroon Thin Line Floor Pad

- General purpose conditioning pad designed to smooth, clean and for the general surface conditioning of wood floors
- Use between coats during floor finishing
- Thin Line Pads are 3/8" thick
- Best used with 175 - 300 RPM machines

4711	◆	11"	Maroon Thin Line	10/cs	1.9 lb
4712	◆	12"	Maroon Thin Line	10/cs	2.2 lb
4713	◆	13"	Maroon Thin Line	10/cs	2.4 lb
4714	◆	14"	Maroon Thin Line	10/cs	2.6 lb
4715	◆	15"	Maroon Thin Line	10/cs	3.0 lb
4716	◆	16"	Maroon Thin Line	10/cs	3.3 lb
4717	◆	17"	Maroon Thin Line	10/cs	3.7 lb
4718	◆	18"	Maroon Thin Line	10/cs	4.1 lb
4719	◆	19"	Maroon Thin Line	10/cs	4.6 lb
4720	◆	20"	Maroon Thin Line	10/cs	5.0 lb
4721	◆	21"	Maroon Thin Line	10/cs	5.8 lb

### D Melamine Floor Pads

- Effective for cleaning and restoring VCT (Vinyl Composition Tile), terrazzo, tile, finished and unfinished concrete and epoxy floors
- Works well with floor machines and auto scrubbers
- Best suited to restore, but are very effective at removing black marks from hallway floors and as grout maintenance
- Made of open-cell Melamine foam
- Environmentally friendly, reduces time/cost; requires only water
- Brown floor pad material back to grip floor machines or auto scrubbers the same as conventional floor pads

7148-17	◆	17"	Melamine	5/cs	3 lb
7148-20	◆	20"	Melamine	5/cs	3 lb

## Specialty Floor Pads

### A Microfibre Burnishing Pads

- Produces minimal or no dust when burnishing
- Increases floor finish gloss; will not burn finish
- Dust and soil are held within the pad and not released into the air
- Soft, fine fibres will not strip or erode finish
- Can be laundered

<b>BURN19S</b> ♦	19"	White	5/cs	4 lb
<b>BURN21S</b> ♦	20"	White	5/cs	5 lb
<b>BURN27S</b> ♦	27"	White	5/cs	8 lb

## Steel Wool Floor Pads

- Can be used for wet and dry applications
- Unique pad construction with no welds, wire or stitches
- Has the strength to cut through dirt and grime, but is gentle on the finest of floors
- Designed to eliminate scratching while buffing to a brilliant luster
- Reversible for longer life
- Sizes and grades to fit every stripping, cleaning and polishing need

### B Ultra Steel Wool Ribbon Floor Pad

- Assorted sizes and grades available by special order; contact customer service

### C Ultra Steel Wool Needled Floor Pad

- Assorted sizes and grades available by special order; contact customer service

## Sandscreens

### D Sandscreens

- Silicon carbide coated screen disc manufactured with the highest degree of quality available
- For wet scrubbing or floor sanding
- Available in various grits and sizes; (Special order) contact a representative for details

<b>6015SD</b> ♦	15"	60 Grit	10/cs	4 lb
<b>6017SD</b> ♦	17"	60 Grit	10/cs	5 lb
<b>6019SD</b> ♦	19"	60 Grit	10/cs	5 lb
<b>6020SD</b> ♦	20"	60 Grit	10/cs	5 lb
<b>8015SD</b> ♦	15"	80 Grit	10/cs	4 lb
<b>8017SD</b> ♦	17"	80 Grit	10/cs	5 lb
<b>8019SD</b> ♦	19"	80 Grit	10/cs	5 lb
<b>8020SD</b> ♦	20"	80 Grit	10/cs	5 lb
<b>1015SD</b> ♦	15"	100 Grit	10/cs	4 lb
<b>1017SD</b> ♦	17"	100 Grit	10/cs	5 lb
<b>1019SD</b> ♦	19"	100 Grit	10/cs	5 lb
<b>1020SD</b> ♦	20"	100 Grit	10/cs	5 lb
<b>1215SD</b> ♦	15"	120 Grit	10/cs	4 lb
<b>1217SD</b> ♦	17"	120 Grit	10/cs	5 lb
<b>1219SD</b> ♦	19"	120 Grit	10/cs	5 lb
<b>1220SD</b> ♦	20"	120 Grit	10/cs	5 lb

♦ Non-stocked item requires special order

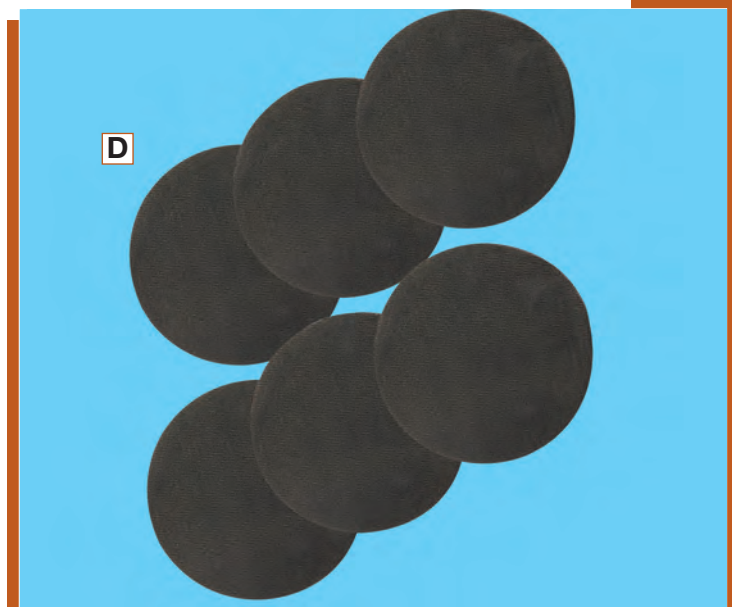
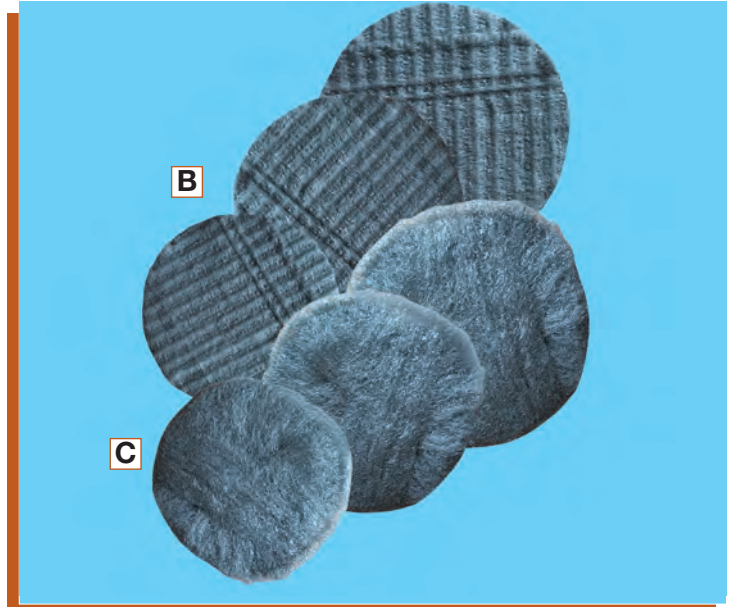



## Carpet Care

### A 201 Slim Line Carpet Bonnets

- An ultra thin, double-faced, low profile carpet scrubbing bonnet
- Aggressive scrubbing action, but easy on the machine
- Excellent for buffing resilient floors

201-15	15"	6/cs	4 lb
201-17	17"	6/cs	5 lb
201-19	19"	6/cs	6 lb
201-21	21"	6/cs	8 lb

### B 202 Rug Boss Carpet Bonnets

- A double-faced, low profile carpet scrubbing bonnet
- Scrubber strips on both sides loosen and lift deeply embedded soil
- All looped construction for improved soil trapping action

202-15	15"	6/cs	8 lb
202-17	17"	6/cs	8 lb
202-19	19"	6/cs	11 lb
202-21	21"	6/cs	13 lb



### C Microfibre Carpet Bonnet

- Designed for durable, deep cleaning of carpet
- Microfibre grabs the dirt and traps it in the fibres; bonnets are very absorbent which allows the carpet to dry quicker
- Can be laundered

BKL19	19"	6/cs	6 lb
-------	-----	------	------

### D Huskee Bristle Sweeper

- 180 degree handle
- Bristle corner brushes
- Low profile design
- Textured paint resists scratches
- Special comb included for maintenance
- Dimensions: 9" D x 9½" W x 45" H

5323	Blue/Grey	Sold ea	2.5 lb
5323-1	Replacement Brush	Sold ea	1.0 lb



### E Brushless Floor & Carpet Sweepers

- The patented rubber singular agitators are effective on all floor types including carpet, wood, tile, etc.
- Outlasts conventional sweepers 8 to 1
- Noiseless operation; easy to clean housing and agitators
- The self-cleaning flexible blades beat the floor with high frequency, creating friction and momentum that cleanly transports dirt, food, lint and other debris
- Sturdy ABS construction with non-marking wheels and rubber corner blades
- Replacement #5323-1 Rotorblade available upon request
- Dimensions for 7401: 8½" D x 9½" W x 44" H
- Dimensions for 7402: 10½" D x 12½" W x 46" H

7401	9½" Black Sweeper	Sold ea	2.5 lb
7402	12½" Black Sweeper	Sold ea	3.5 lb

◆ Non-stocked item requires special order

## Pad Holders

### A Utility Pad Holders

- New built-in teeth on base accept 10" x 4½" cleaning pads
- Permits swivel action in all directions
- 2000AT Acme Threaded socket accepts ½" threaded handles; 2007U Universal socket accepts all other handles (**see page 58**)
- Dimensions: 9½" L x 3⅝" W

<b>2007U</b>	Grey	Universal	12/cs	3 lb
<b>2000AT</b>	Grey	Acme Threaded	12/cs	3 lb

### B 430 Pad Holder

- Gripper teeth on base accept all standard pads
- Multi-directional rotation allows use in hard-to-reach areas
- Dimensions: 9½" L x 3½" W

<b>430</b>	Blue	Universal	Sold ea	0.25 lb
<b>430-50</b>	Blue	Universal	50/cs	12.5 lb

### C 431 Swivel Pad Holder

- Accepts all standard pads
- Threaded socket accepts all Acme Threaded Handles
- Hooked base holds 10" x 4½" cleaning pads

<b>431</b>	Blue	Acme Threaded	10/cs	4 lb
------------	------	---------------	-------	------

### D Hand Held Pad Holder

- Velcro grid system locks highly abrasive pads firmly in place
- Dimensions: 9½" L x 3½" W

<b>404</b>	Blue/Black	Sold ea	1 lb
------------	------------	---------	------

## Utility Pads

- Fits 2000AT, 2007U, 430 & 404
- Dimensions: 10" L x 4½" W

### E Melamine Doodlebug Pad

- Attaches to utility pad holders with velcro strips
- Eliminate stains and marks on walls and floors
- Chemical-free; requires only water
- Effective on hard, smooth surfaces; not for use on wood
- Dimensions: 10" L x 4½" W

<b>7154</b>	Melamine/Brown Pad	8/cs	0.8 lb
-------------	--------------------	------	--------

### F Light-Duty Pad

- Delicate surface and light cleanups such as sinks, tile and windows

<b>84A</b>	White	5/pk	4 pks/cs	2 lb
------------	-------	------	----------	------

### G Medium-Duty Pad

- Medium abrasive for scuffs and finishes requiring more than a light pad

<b>82A</b>	Blue	5/pk	4 pks/cs	2 lb
------------	------	------	----------	------

### H Heavy-Duty Pads

- Aggressive for floors, baseboards and corners
- Easily removes old finish and wax build-up

<b>85A</b>	Brown	5/pk	4 pks/cs	4 lb
<b>83A</b>	Black	5/pk	4 pks/cs	4 lb

### I Wall Washer Pad

- Comes pre-laundered; cotton and launderable
- Can also be used for dust mopping small areas
- Dimensions: 10" L x 5" W

<b>09292</b>	Natural Cotton	20/cs	3.5 lb
--------------	----------------	-------	--------

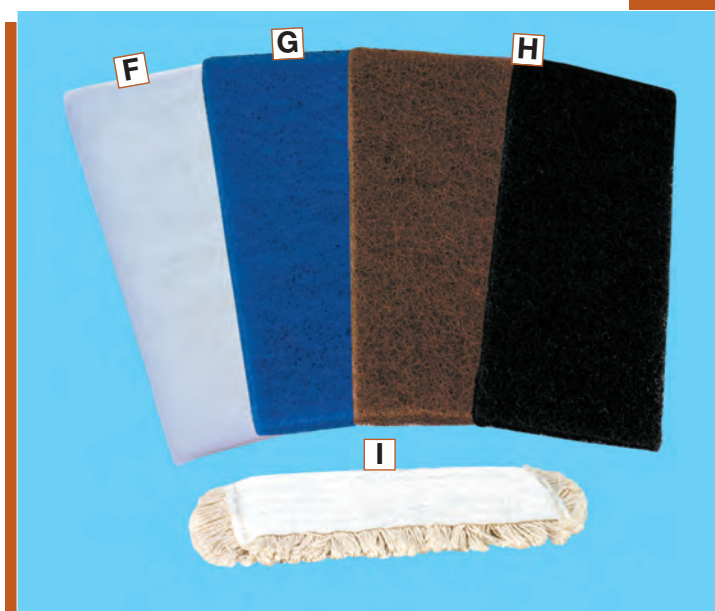
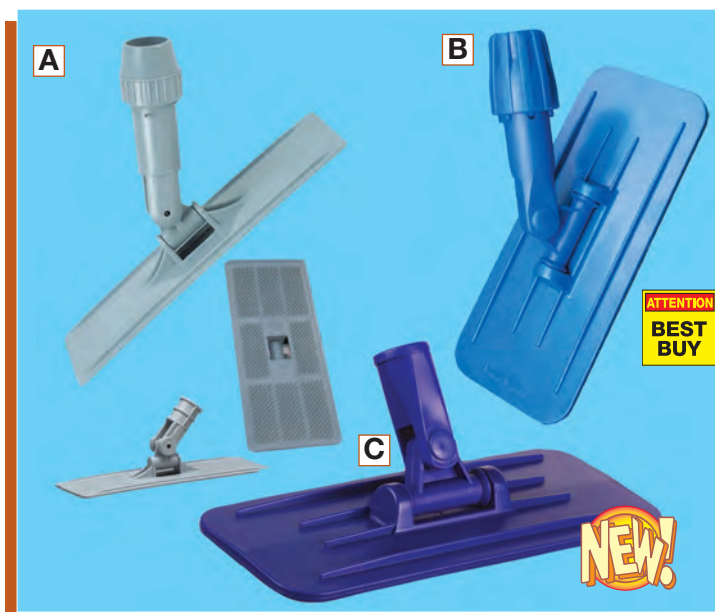



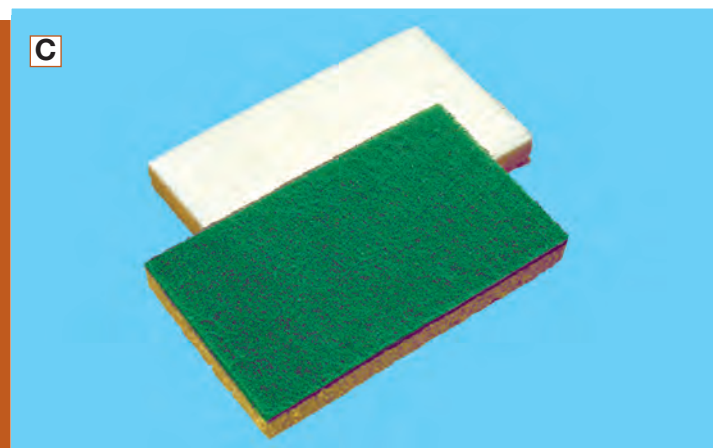
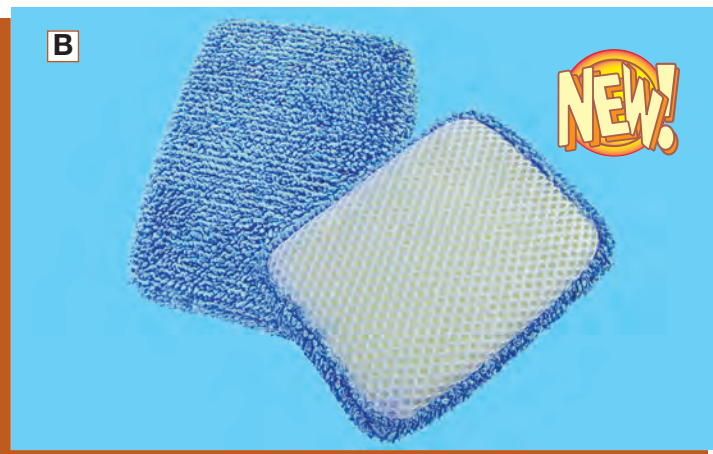

## Sponges

### A Cellulose Sponges

- Industry standard sponges
- Ideal for various working conditions
- Reinforced fibres to promote a long life
- Rinse and clean easily for repeated usage

#### Utility

- Dimensions: 6" L x 3 3/8" W x 7/8" H

661	Yellow	24/cs	1.5 lb
-----	--------	-------	--------

#### Medium

- Dimensions: 6" L x 4" W x 1 1/2" H

663	Yellow	24/cs	2 lb
-----	--------	-------	------

#### Large

- Dimensions: 7 1/4" L x 4 1/4" W x 1 3/4" H

665	Yellow	24/cs	5 lb
-----	--------	-------	------

### B Microfibre Sponge

- Easy to use, sized to the hand
- Covered with Microfibre on the top and sides; backing is covered with mesh scrubber
- Excellent absorption with deep soil extraction and microfibre's ability to hold dirt
- Dimensions: 3 1/2" L x 5" W x 1" H

SMLSPNG	Blue	180/cs	10 lb
---------	------	--------	-------

## Scrubbing Sponges

### C Scrubbing Sponges

- This versatile cleaning tool combines a nylon cleaning or scouring pad with an absorbent **cellulose sponge**
- No rust or stains, easy on hands
- Can be washed for reuse; absorbent for fast wipe up
- Scrub with one side and wipe with the other
- Combine with cleaning solutions for faster action
- Dimensions: 6 1/4" L x 3 5/8" W

#### Regular duty

74C	Green/Yellow	40/cs	4.0 lb
74612	Green/Yellow	20/cs	2.5 lb

#### Light duty

63C	White/Yellow	40/cs	3.6 lb
63614	White/Yellow	20/cs	2.5 lb

### D Halves Medium Scrubber Sponge

- Yellow cellulose sponge with medium duty green pad
- Antimicrobial treated; moist and individually wrapped
- No rust or stains, easy on hands
- Dimensions: 3 1/2" x 3 1/2"

SC200	Green/Yellow	40/cs	2.5 lb
-------	--------------	-------	--------

### E Halves White Scrubber Sponge

- Yellow polyfoam sponge with light duty white pad
- Antimicrobial treated; moist and individually wrapped
- No rust or stains, easy on hands
- Dimensions: 3 1/2" x 3 1/2"

PY400	White/Yellow	40/cs	2.5 lb
-------	--------------	-------	--------

❖ Non-stocked item requires special order

## Scrubbing Sponges

### A Polyurethane Medium Scrubber Sponge

- Yellow polyurethane sponge with medium duty green pad for economical cleaning
- Poly sponge is more hygienic; does not dry out
- Individually wrapped; dimensions: 6" x 3 $\frac{3}{8}$ " x  $\frac{3}{4}$ "

SC300	Green/Yellow	40/cs	4.4 lb
-------	--------------	-------	--------

### B Halves Polyurethane Medium Scrubber Sponge

- Yellow polyurethane sponge with medium duty green pad for economical cleaning
- Poly sponge is more hygienic; does not dry out
- Individually wrapped; dimensions: 3 $\frac{1}{2}$ " x 3 $\frac{1}{2}$ " x  $\frac{3}{4}$ "

PY200	Green/Yellow	40/cs	2.5 lb
-------	--------------	-------	--------



## Contoured Sponge & Scouring Pad

### C Cool Blue Scrubber Sponge

- Contour-cut yellow cellulose sponge backed with Cool Blue Antimicrobial scratch-less hand pad
- Ideal for all purpose cleaning
- Provides maximum cleaning power with minimal scratch
- Dimensions: 6 $\frac{1}{4}$ " L x 3 $\frac{1}{4}$ " W x  $\frac{3}{4}$ " H

30613	Blue/Yellow	20/cs	2.5 lb
-------	-------------	-------	--------

### D Blue Sapphire Max Power Scouring Pad

- Tough, but will not scratch like a metal scrubber
- Open weave design rinses clean
- Dimensions: 6" L x 4" W x  $\frac{5}{8}$ " H

752020	Blue	24/cs	1 lb
--------	------	-------	------



## Soap Sponge

### E Tough Scour™ Nylon Soap Sponge

- Three-layer construction is ideal for commercial kitchen cleaning
- Consists of two nylon scrubbing surfaces with a foam centre
- Foam sponge filled with highly concentrated liquid detergent
- Individually wrapped; 3 $\frac{1}{2}$ " x 3 $\frac{1}{4}$ " x  $\frac{3}{4}$ "

24-005B	Green/White	20/cs	2.5 lb
---------	-------------	-------	--------



## Scouring Pads

### F Plastic Mesh Power Scrubber

- Best used on Teflon®, Silverstone®, glassware and china
- Made from a non-abrasive filament
- Ideal for cleaning the inside of microwave ovens

PS700	Red	24/cs	2 lb
-------	-----	-------	------

### G Metal Scouring Pads Extra Heavy-Duty Stainless Steel

- Great for highly aggressive cleaning jobs
- FDA and USDA approved
- Will not rust, corrode, tear or splinter

10-100	Stainless Steel	50 g	12/pk	1.5 lb
--------	-----------------	------	-------	--------

#### Regular Stainless Steel

- Industry standard - sturdy, yet economical

434SPB	Stainless Steel	35 g	12/pk	1 lb
--------	-----------------	------	-------	------

434PB	Stainless Steel	50 g	12/pk	2 lb
-------	-----------------	------	-------	------

#### Brass

- Made for cleaning softer metals; easy on hands

BRASS35	Brass	35 g	12/pk	1 lb
---------	-------	------	-------	------

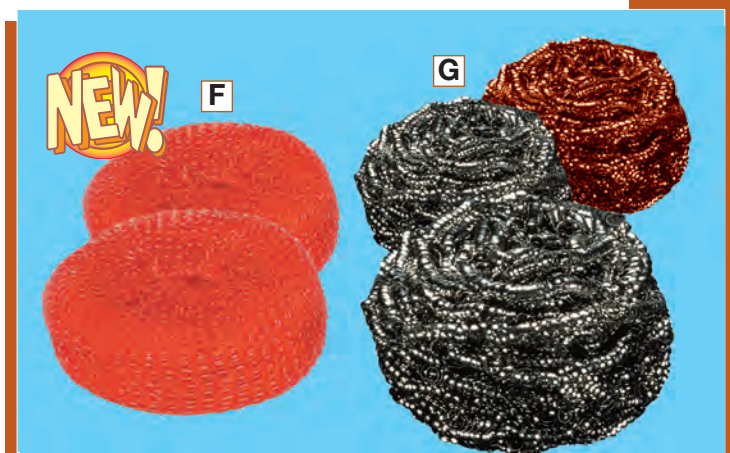



## Scouring Pads

### A Hand Scouring Pads

- Features make maintenance cleaning more efficient, saving time and expensive labour costs
- Non-metallic, no rust stains or splinters
- Resilient open web design
- Can be washed out for reuse
- Conforms to cracks and crevices on surfaces being cleaned
- Dimensions for all scouring pads: 9" L x 6" W

#### Regular duty

<b>96A</b>	Green	60/cs	3 lb
<b>96C</b>	Green	100 Bulk	5 lb

#### Heavy duty

<b>86B</b>	Green	60/cs	4 lb
------------	-------	-------	------

#### Light duty

<b>98604</b>	White	60/cs	4 lb
--------------	-------	-------	------

#### Antimicrobial treated

<b>96601A</b>	Green General Purpose	20/cs	1.7 lb
<b>86606A</b>	Green Heavy Duty	20/cs	1.9 lb

### B All Purpose Maroon Hand Scouring Pad

- Made of tough, non-woven material impregnated with an abrasive grain and bonded with synthetic resin
- Ideal for removing rust and corrosion for surface preparation

<b>617</b>	Maroon	60/cs	4 lb
------------	--------	-------	------

### C Cool Blue All Purpose Scratchless Pad

- Provides excellent cleaning power with less scratching
- Antimicrobial treated; outperforms and outlasts other scouring pads
- Hand size; dimensions: 6" x 4"

<b>SP30</b>	Blue	40/cs	1.3 lb
-------------	------	-------	--------

### D Heavy Duty Scouring Pad

- Extra heavy-duty abrasive scouring pad; tough nylon blend
- Open weave construction easily stands up to baked on foods and crusty equipment
- Hand size; dimensions: 6" L x 3½" W x ¾" H

<b>SO88</b>	Blue	40/cs	2.4 lb
-------------	------	-------	--------

### E Hand Size Light Duty Scouring Pad

- Non-abrasive pad; it is tough but gentle
- Will not cause scratches
- Specially designed for cleaning porcelain, ceramic, fine china and other delicate surfaces
- Dimensions: 3½" L x 6" W

<b>90030</b>	White	40/cs	3 lb
--------------	-------	-------	------

### F Hand Size Scouring Pad

- Features make maintenance cleaning more efficient, saving time and expensive labour costs
- Non-metallic, no rust stains or splinters
- Resilient open web design; can be washed out for reuse
- Conforms to cracks and crevices on surfaces being cleaned
- Dimensions: 3½" L x 6" W

<b>96050</b>	Green	60/cs	3 lb
--------------	-------	-------	------

❖ Non-stocked item requires special order

## Cleaning & Scouring Pads

### A Large Hotel Size Soap Pads

- 25% larger than all other pads on the market
- Specifically designed for hotels, restaurants and institutions
- Manufactured from first quality double layered steel wool
- Fully saturated with a commercial grade soap formulation
- Polishes and cleans in one simple operation to make tough cleaning jobs easier

<b>A240000</b>	Soap Pads	10/pk	12 pk/cs	1 lb
----------------	-----------	-------	----------	------

### B Griddle Brick

- Will not scratch grill or lift surface cure
- Sanitary because it is nonporous
- Economical because you can reuse it many times

<b>GB12</b>	Black	12/cs	7 lb
-------------	-------	-------	------

### C Steel Wool Pads

- Packaged 16 pads per bag; 12 bags per case
- Available in 8 grades, each with a variety of uses

<b>T0000</b>	#0000	16/bag	12 bg/cs	9 lb
<b>T000</b> ♦	#000	16/bag	12 bg/cs	9 lb
<b>T00</b>	#00	16/bag	12 bg/cs	9 lb
<b>T0</b>	#0	16/bag	12 bg/cs	9 lb
<b>T1</b>	#1	16/bag	12 bg/cs	9 lb
<b>T2</b>	#2	16/bag	12 bg/cs	9 lb
<b>T3</b>	#3	16/bag	12 bg/cs	9 lb
<b>T4</b> ♦	#4	16/bag	12 bg/cs	9 lb

### D Smoke Sponge

- No chemicals or abrasives
- Removes marks from walls, especially effective for smoke damage restoration
- Individually wrapped
- Dimensions: 6" L x 3½" W x 1½" H

<b>56103</b>	Smoke Sponge	12/cs	4 lb
--------------	--------------	-------	------

### E Melamine Eradicator Sponges

- Eliminate stains and marks on appliances, walls, fixtures, office equipment, patio furniture, car interiors/exteriors, etc.
- Chemical-free; requires only water
- Most effective on hard, smooth surfaces
- Fits comfortably in hand
- Yellow gripping in middle prolongs use and improves performance of the 7150
- 7152 Wavy Sponge includes brown scouring pad for tougher stains
- 7153 Shaminator Sponge features a chamois side for mopping up spills and extra water released from the melamine
- Dimensions 7149: 4½" L x 2½" W x 1" H
- Dimensions 7150: 4¼" L x 2¾" W x 1½" H
- Dimensions 7152: 4½" L x 2¼" W x 7⁄8" H
- Dimensions 7153: 6¼" L x 4" W x 1" H

<b>7149</b>	White	24/cs	0.4 lb
<b>7150</b>	Yellow/White	24/cs	2.0 lb
<b>7152</b>	Wavy Brown Pad/White	110/cs	2.4 lb
<b>7153</b>	Shaminator Orange/White	20/cs	0.8 lb

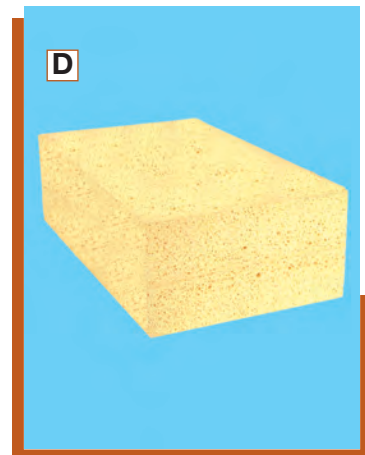
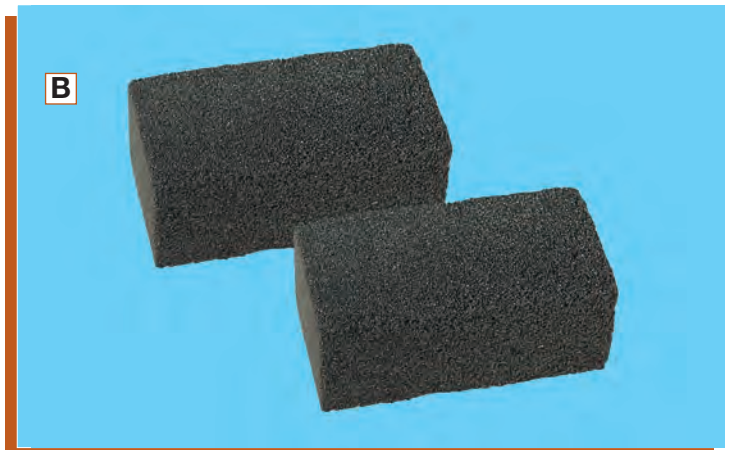



## Wall Washer

### A Wall Washer

- Clean all types of walls while eliminating drips, tarps, ladders, and bulky equipment
- The lightweight, anodized aluminum handle is telescopic, extending from 55" to 92" to get at hard to reach areas
- Launderable and reusable yarn mop head
- Replacement mops sold separately

9501	Wall Washer with Wire Frame	6/cs	6 lb
9516	Wall Washer with Plastic Frame	6/cs	12 lb
9502	Repl. Tie-On Cotton Mop	12/cs	3 lb
9503	Repl. Velcro Cotton Mop	12/cs	4 lb
9503MF	Replacement Microfibre Mop	12/cs	4 lb
9504	Drip Arrestor Sponge	12/cs	3 lb

## Dust Mops

### B Premium Looped Dust Mops

- Specially developed yarns for superior dust pick up
- Fast drying time reduces laundering costs
- Looped end yarn resists linting and fraying, even after prolonged use and frequent machine washings (for Laundry Net Bag, please see page 43)
- Blue mop yarn conceals dirt
- Universal fit, tie-on style fits both rigid and breakaway frames
- Fits 5" frames; comes polybagged

10542	18" (45.7 cm)	10/cs	6 lb
10543	24" (61.0 cm)	10/cs	8 lb
10545	36" (91.4 cm)	10/cs	11 lb
10546 ♦	48" (121.9 cm)	5/cs	9 lb

### C Microfibre Pocket Dust Mop

- Fits traditional 5" metal dust mop frame
- For dry/dust cleaning only
- Large loop microfibre picks up more particles of dust and trash
- Mop attracts dust electrostatically and requires no treatment

LDPB18	18"	Blue	12/bg	8 lb
LDPB24	24"	Blue	12/bg	11 lb
LDPB36	36"	Blue	12/bg	14 lb

### D Microfibre Dry Dust Mop

- Cut-end microfibre with fringe pick up larger particles of dust and trash
- Poly/canvas backed microfibre mops attract and hold dust that cotton mops leave behind
- Colour-coded canvas backing by size - yellow 18", green 24", red 36", blue 48"
- Attracts dust electrostatically and requires no treatment
- Envelope style backing eliminates problems created by ties or snaps while still using traditional 5" dust mop frames
- Extra padding in the mop allows for complete surface contact

LFCB18	18"	Grey/Yellow	12/bg	5.0 lb
LFCB24	24"	Grey/Green	12/bg	6.0 lb
LFCB36	36"	Grey/Red	12/bg	8.5 lb
LFCB48	48"	Grey/Blue	12/bg	10.5 lb

♦ Non-stocked item requires special order

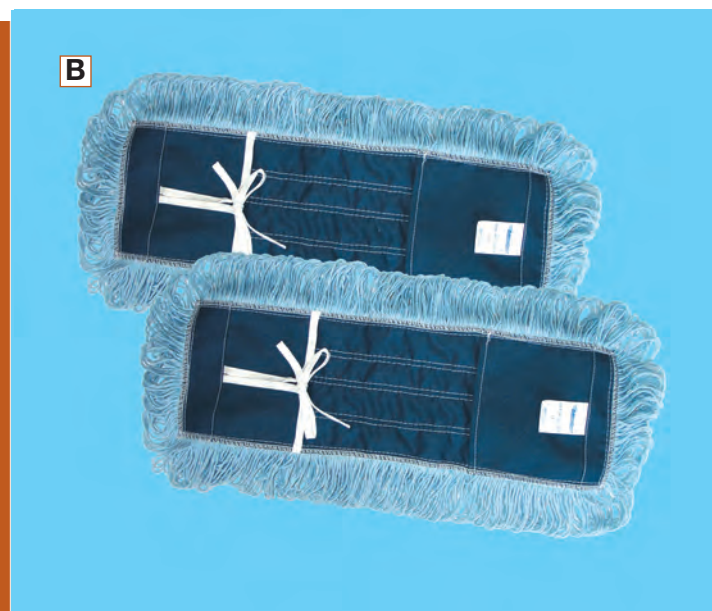

## Dust Mops & Frames

### A Premium Synthetic Dust Mops

- Electrostatically charged yarns with cut ends
- Premium fabric back with ties
- Blue mop yarn conceals dirt
- Fits 5" frames

41818-2	18" (45.7 cm)	12/cs	6 lb
41824-2	24" (61.0 cm)	12/cs	10 lb
41836-2	36" (91.4 cm)	12/cs	11 lb
41848-2	48" (121.9 cm)	12/cs	12 lb

### B Standard Cotton Dust Mops

- Durable, premium quality cotton with cut ends
- Readily accepts mop treatment
- Cleans easily when shaken, brushed or vacuumed
- Rugged, heavy-duty backing ensures longer mop life
- Fully launderable when washed in mesh bag (see page 40)
- Universal fit, tie-on style fits both rigid and breakaway frames
- Fits 5" frames; comes polybagged

CDM18	18" (45.7 cm)	10/cs	8 lb
CDM24	24" (61.0 cm)	10/cs	10 lb
CDM36	36" (91.4 cm)	10/cs	14 lb
CDM48	48" (121.9 cm)	5/cs	9 lb

### C Snap-On Dust Mop Rigid Frames

- Heavy-duty, 5" wide, black powder coated rigid metal frame
- Accepts slip-on, tie-on, split boot and disposable dust mops
- Use with SOH64 Snap-On Dust Mop Wood Handle

SO18	18" (45.7 cm)	Sold ea	0.8 lb
SO24	24" (61.0 cm)	Sold ea	1.0 lb
SO36	36" (91.4 cm)	Sold ea	1.7 lb

### D Snap-On Dust Mop Wood Handle

- Includes snap-on fitting with 360° swivel or rigid setting
- Dimensions: 64" L

SOH64	64" Overall Length	Sold ea	0.8 lb
-------	--------------------	---------	--------

### E Breakaway Frames

- Collapsible, plated, 5" wide steel frame
- Allows hands-free removal of soiled mops
- Includes bolted fastener and has 360° swivel action

#### Breakaway Frame & Handle Complete

- Comes with ( DMH60 ) 60" wood handle

DMFH18	18" (45.7 cm)	10/cs	28 lb
DMFH24	24" (61.0 cm)	10/cs	30 lb
DMFH36	36" (91.4 cm)	10/cs	40 lb
DMFH48	48" (121.9 cm)	5/cs	25 lb

#### Breakaway Frame Only

- Use with DMH60 Breakaway Wood Handle

DMF18	18" (45.7 cm)	12/cs	17 lb
DMF24	24" (61.0 cm)	12/cs	19 lb
DMF36	36" (91.4 cm)	12/cs	30 lb
DMF48	48" (121.9 cm)	6/cs	21 lb

#### Breakaway Wood Handle Only

- Dimensions: 60" L x 1" Dia.

DMH60	60" Overall Length	Sold ea	1.4 lb
-------	--------------------	---------	--------

◆ Non-stocked item requires special order

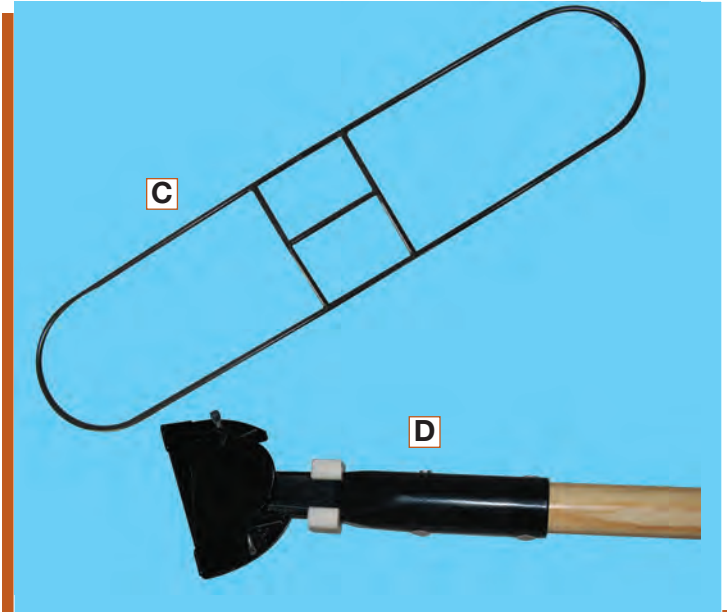



## Dust Magnet Dry Mop System

### A Dust Magnet/Moplux Standard Tool Set

- The best solution for clean-ups where strict attention to health standards is necessary
- Includes 23" Standard Holder (0584237000) and Adjustable Handle (0584357000)

<b>MT4071</b>	Complete	1/cs	2 lb
---------------	----------	------	------

### Standard Holder

- Uses clips to keep the Dust Magnet sheets in place
- A padded underside makes it safe for almost any surface

<b>0584237000</b>	23"	1/cs	1 lb
-------------------	-----	------	------

### Standard Handle

- Fits 23" Standard Holder (0584237000)

<b>0584400000</b>	60"	1/cs	1 lb
-------------------	-----	------	------

### Adjustable Handle

- Handle quickly attaches to the frame and easily telescopes to the perfect length

<b>0584357000</b>	40"-71"	1/cs	1 lb
-------------------	---------	------	------

### B Ergobend

- Fits both standard and adjustable handles
- Attaches in between the handle and the mop frame
- The unique bend and swivel action allows cleaning on top of high shelves and other hard-to-reach areas

<b>0584320000</b>		1/cs	0.5 lb
-------------------	--	------	--------

### C Dust Magnet Sheets

- The Dust Magnet reduces the risk of cross contamination by creating an electrical charge that picks up dust, allergens, bacteria and pollen
- Dust Magnet sheets are disposed of after each use to minimize the handling of dirty/contaminated mops

<b>0584022000</b>		200/cs	6 lb
-------------------	--	--------	------

## Treated Dust Cloths

### D Treated Dust Cloth

- Use for building maintenance/contract cleaning or in institutions such as hospitals, long term care facilities and schools
- Use for floors or hand dusting
- For general dusting, including office and computer equipment
- Light oil treatment removes dust without using dusting agents
- Convenient size for floor and hand dusting
- Unique dust cloth fabric stretches to capture and retain dust particles
- Fits MT4071 Standard Tool Set (not included)
- Towel Dimensions: 24" L x 24" W

<b>2925</b>	Yellow	200/cs	7 lb
-------------	--------	--------	------

❖ Non-stocked item requires special order

## Spray Cleaning Systems

### A Tile & Grout Spray Cleaning System

- Clean natural stone and tile including grout lines
- White bristles clean the top surface of stone and tile and are especially effective with uneven, textured and raised patterns
- Black diamond shaped bristles are designed to reach deep into grout lines to remove the most embedded dirt and stains

<b>B100517</b>	30 oz Reservoir	1/cs	4 lb
----------------	-----------------	------	------

### B Carpet & Rug Spray Cleaning System

- Cleans small to medium carpeted areas, i.e. high traffic hallways, hotel guest rooms and small retail stores
- Patented brush on wheels provides two levels of agitation - white bristles with light to medium aggressiveness for sensitive carpets and stiff black bristles to deep clean and remove embedded dirt and stains
- Excellent for grooming all types of carpet and to lift pet hair

<b>B100516</b>	30 oz Reservoir	1/cs	4 lb
----------------	-----------------	------	------



## Accessories

### C The Original Lint High Roller

- 50 sheets/layers
- Easy to rip perforated sheet removal system
- Picks up lint, dust, dandruff, hair, cobwebs and debris for light housekeeping
- Use on bedding, lamp shades, upholstery, clothing, floors, walls, ceilings, etc.
- Use the 8" roller with the 53165TH Extension Pole to reach ceilings or floors; extends from 31 1/4" to 60"

<b>RO61175</b>	8" Adhesive Roller Refills	6/cs	2.6 lb
<b>RO61176</b>	4" Adhesive Roller Refills	12/cs	2.6 lb
<b>HAB7653</b>	8" Roller Tool	24/cs	12.0 lb
<b>HAHC001</b>	4" Roller Tool	24/cs	8.0 lb
<b>53165TH</b>	Extension Pole	Sold ea.	0.5 lb

### D Laundry Net Bag

- Durable polyester mesh bag with drawstring lock closure and convenient ID patch sewn in
- Helps prevent tangles and damage when laundering wet mops, dust mops and any other launderable items
- Dimensions for **9006**: 32" L x 21" W

<b>9006</b>	White	Sold ea	0.3 lb
-------------	-------	---------	--------

- Dimensions for **9007**: 36" L x 24" W

<b>9007</b>	White	Sold ea	0.5 lb
-------------	-------	---------	--------

### E Stripping Boots

- Excellent for spot cleaning tough areas without bending
- Best available slip protection on wet floors
- Protects footwear against water and harsh chemicals
- Full coverage Velcro® pads provide superior strip pad attachment

<b>KITSBLG</b>	MED/LG with 2 Repl Soles	1 kit/cs	1.8 lb
<b>KITSBXLG</b>	LG/XL with 2 Repl Soles	1 kit/cs	2.2 lb
<b>KITSBXXL</b>	XXL with 2 Repl Soles	1 kit/cs	2.2 lb
<b>RS-LG</b>	MED/LG Replacement Soles	3 pr/cs	1.0 lb
<b>RS-XLG</b>	LG/XL Replacement Soles	3 pr/cs	1.2 lb
<b>RS-XXL</b>	XXL Replacement Soles	3 pr/cs	1.2 lb





## Utility Pails



### A 6 qt Utility PuraPail®

- Made of high density polypropylene with metal handle
- Embossed graduations for easy measurement
- Fits conveniently in a janitor's cart
- Labelled for dedicated use of cleaning and sanitizing solutions
- Reduces risk of cross-contamination
- Dimensions: 7" L x 9" W x 7½" H

<b>5506-6S</b>	Red Sanitizing	12/cs	5 lb
<b>5506-14C</b>	Green Cleaning	12/cs	5 lb



### B 10 U.S. qt Sanitizer Pail

- Graduated U.S. quart and litre measurements
- Insulated steel bail handle
- Handle continuously looped around bail ear
- Dimensions: 10⅝" Dia. x 10¼" H

<b>9010RD-S</b>	Red with Sanitizer Imprint	12/cs	11 lb
-----------------	----------------------------	-------	-------



### C 6 qt Utility Pail

- Made of high density polypropylene with metal handle
- Embossed graduations for easy measurement
- Square design fits easily in janitor's cart
- Use for general purpose cleaning, etc.
- Dimensions: 7" L x 9" W x 7½" H

<b>5506</b>	Translucent White	48/cs	19 lb
-------------	-------------------	-------	-------



### D 14 U.S. qt Heavy-Duty Pails

- Graduated U.S. quart and litre measurements
- Insulated steel bail handle
- Handle continuously looped around bail ear
- Dimensions: 12⅝" Dia. x 11¼" H

<b>9014GY</b>	Grey	12/cs	22 lb
<b>9014RD</b>	Red	12/cs	22 lb



### E 10 U.S. qt Heavy-Duty Pails

- Graduated U.S. quart and litre measurements
- Insulated steel bail handle
- Handle continuously looped around bail ear
- Dimensions: 10⅝" Dia. x 10¼" H

<b>9010GY</b>	Grey	12/cs	11 lb
<b>9010RD</b>	Red	12/cs	11 lb



### F 11 qt Econo Medium Weight Pail

- Moulded pour spout
- Grooved bottom for easy grip when pouring
- Metal insulated bail handle
- Dimensions: 11½" Dia. x 9½" H

<b>1115</b>	Grey	12/cs	10 lb
-------------	------	-------	-------



### G 15 qt Plastic Rectangular Pail

- Insulated metal bail handle and moulded pour spout
- Dimensions: 16½" L x 10" W x 9½" H

<b>802</b>	Blue	6/cs	12 lb
<b>800</b>	Blue (with wringer)	6/cs	18 lb

❖ Non-stocked item requires special order

## Divided Pails

### A Divided Pail With Wringer

- Features a divided bucket with heavy-duty snap-on cone wringer
- Wringer slides from side to side accessing both compartments
- Accommodates mops up to 16 oz
- Dimensions: 35" W x 13½" D x 10½" H

142	Grey	6/cs	20.5 lb
-----	------	------	---------

### B 16 U.S. qt Divided Pail

- 16 quart capacity, double compartments
- Convenient spout for neat pouring
- Embossed graduations in quarts and litres
- Dimensions: 18" L x 14½" W x 11" H

8216	Grey	5/cs	14 lb
------	------	------	-------



## Stainless Steel & Metal Pails

### C Seamless Stainless Steel Pails

- Multi-purpose; use for industry, at home or on the farm
- Food grade made from Heavy Duty 26 gauge stainless steel
- Riveted handle lugs give the pail a smooth top rim
- Lugs allow the pails to nest without sticking

30254	10 L	10½" dia. x 20½" H	12/cs	19 lb
30255	13 L	12" dia. x 22" H	12/cs	24 lb
30256	17 L	13" dia. x 22" H	12/cs	32 lb

### D Metal Pails

- Constructed of pre-galvanized steel
- Made water tight with special sealant

410	8 qt	10¾" Dia. x 9" H	6/cs	11 lb
414	10.5 qt	11¾" Dia. x 10" H	6/cs	12 lb
416	13 qt	11¾" Dia. x 11" H	6/cs	13 lb



## Door Stops

### E Super Door Stop

- Hold the door without bending over and reduce injury costs due to back strain or improperly secured doors
- A built in magnet allows you to secure it to any metal surface and keep it close at hand
- Patented design and unique material combine to secure doors on almost any surface, including commercial carpet

280173	Yellow	6/cs	2 lb
--------	--------	------	------

### F Regular Door Stop

- Heavy duty rubber; fits most doors
- Eliminates use of ugly, unsafe, homemade wooden door stops

7263	Grey	12/cs	4 lb
------	------	-------	------

### G Large Door Stop

- Huge size will accommodate most doors and will hold with higher clearance
- Bright colour for safety and high visibility
- Dimensions: 6¼" L x 3½" W x 2" H

7265	Yellow/Green	12/cs	2 lb
------	--------------	-------	------

### H Mini Door Stop

- Ideal for use when moving furniture, stripping floors, etc.

7260	Brown	24/cs	2 lb
------	-------	-------	------

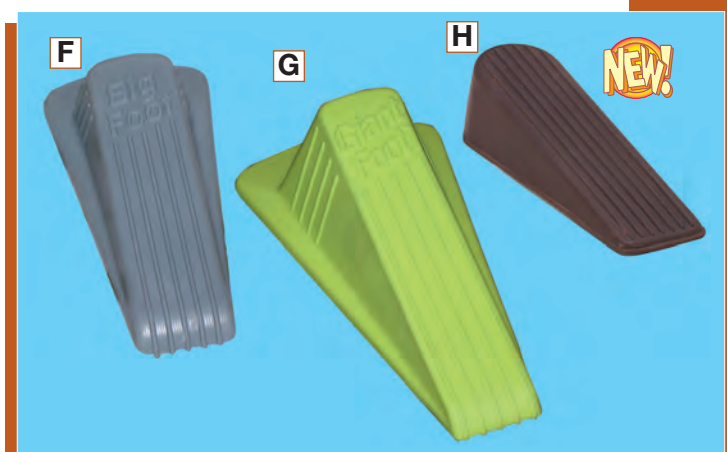

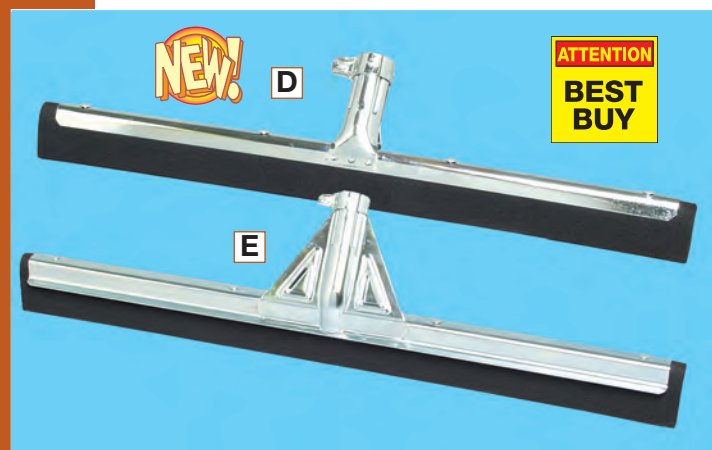
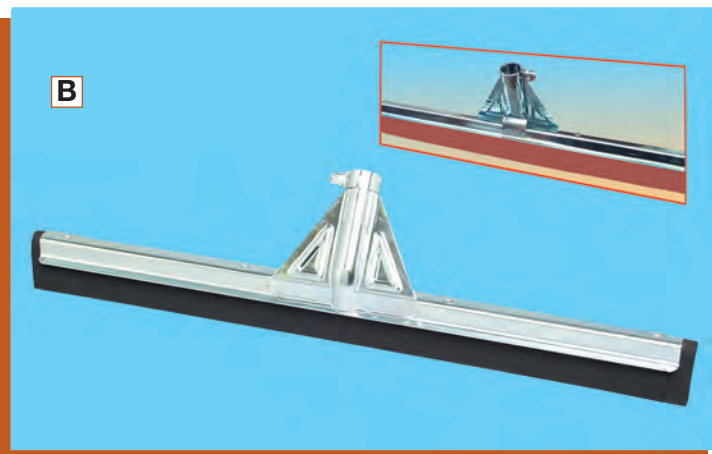
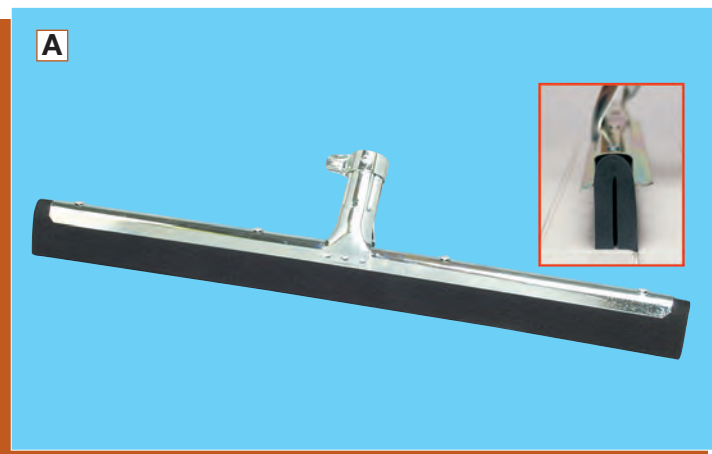

## Duro Moss Rubber Squeegees

### Duro Moss Squeegees - Metal Frames

- Unique twin rubber blades will leave floors dry to the touch
- Ideal for removing liquids, dirt and quick drying
- The patented Adjustable Socket System fits all handles up to 3/4" diameter (see page 58)
- Available with black rubber or red neoprene blades

#### A Standard with Light Metal Frame

- Economic all-purpose squeegee
- The twin natural moss black rubber blades are securely held into the galvanized metal frame with a riveted and galvanized locking strip
- Can be used for both residential and professional applications in kitchens, patios, decks and garages

<b>8340</b>	18"	Black	10/cs	5 lb
<b>8350</b>	22"	Black	10/cs	8 lb

#### B Heavy-duty with Heavy Metal Frame

- The twin blades move large amounts of liquid and dirt
- The special splash guards prevent the water from spilling over the galvanized frame
- The reinforced handle socket is secured to the frame with 6 solid spot-welds for heavy-duty applications
- Ideal for tough, industrial work in factories, supermarkets, warehouses and gas stations

<b>8356</b>	22"	Black	10/cs	11 lb
<b>8375</b>	30"	Black	10/cs	15 lb
<b>8377</b>	30"	Red	10/cs	15 lb

#### C Duro Moss Squeegees with Acme Threaded Insert

- Fits all Acme threaded handles

##### Light Metal Frame

<b>8340A</b>	18"	Black	10/cs	5 lb
<b>8350A</b>	22"	Black	10/cs	8 lb

##### Heavy Metal Frame

<b>8356A</b>	22"	Black	10/cs	11 lb
<b>8375A</b>	30"	Black	10/cs	15 lb
<b>8377A</b>	30"	Red	10/cs	15 lb

## Synthetic Moss Rubber Squeegees

### D Synthetic Moss Squeegees - Metal Frames

- Same features as the Duro Moss Squeegee, but with an economical synthetic Moss rubber blade

<b>8340S</b>	18"	Black	Adjustable Socket	10/cs	5.0 lb
<b>8340SA</b>	18"	Black	Acme Threaded	10/cs	5.0 lb
<b>8350S</b>	22"	Black	Adjustable Socket	10/cs	7.4 lb
<b>8350SA</b>	22"	Black	Acme Threaded	10/cs	7.5 lb

### E Synthetic Moss with Heavy Metal Frame

- Same features as the Heavy-Duty Duro Moss Squeegee, but with an economical synthetic Moss rubber blade

<b>8356S</b>	22"	Black	Adjustable Socket	10/cs	11 lb
<b>8356SA</b>	22"	Black	Acme Threaded	10/cs	11 lb
<b>8375S</b>	30"	Black	Adjustable Socket	10/cs	15 lb
<b>8375SA</b>	30"	Black	Acme Threaded	10/cs	15 lb

## Floor Squeegees Metal Frame

- Heavy metal frames are zinc plated, corrosion resistant and feature a built-in scraper to remove stubborn stains
- Durable blades are secured with rust resistant screws
- All floor squeegees use tapered handles, depending on choice of lengths
- Ideal for industrial, professional and commercial use
- Replacement blades sold separately

### A Straight Dual Edge

#### Grey Rubber Blade

222-18	18"	6/cs	4 lb
222-24	24"	6/cs	5 lb
222-30	30"	6/cs	6 lb
222-36	36"	6/cs	8 lb

#### Black Neoprene Rubber Blade

228-24	24"	2/cs	6 lb
--------	-----	------	------

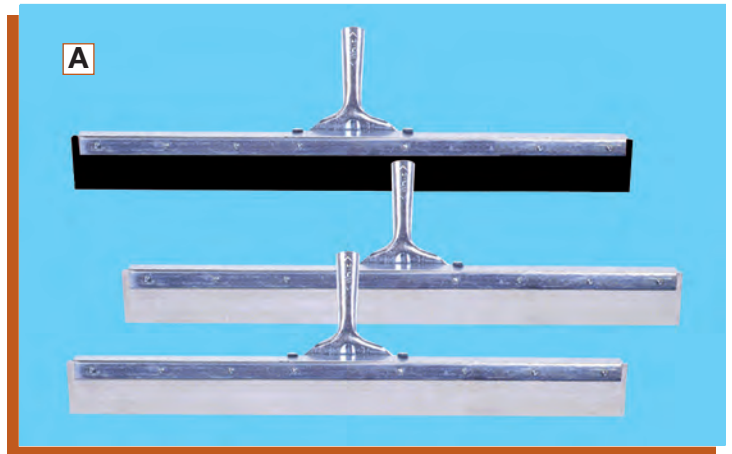

## Floor Squeegees Plastic Frame

### B Duro Moss Squeegees - Plastic Frames

- Food service approved
- New model with acme thread and universal connector
- Accepts up to 1" threaded acme handles

PP22B	22"	Black	10/cs	7 lb
PP22R	22"	Red	10/cs	7 lb

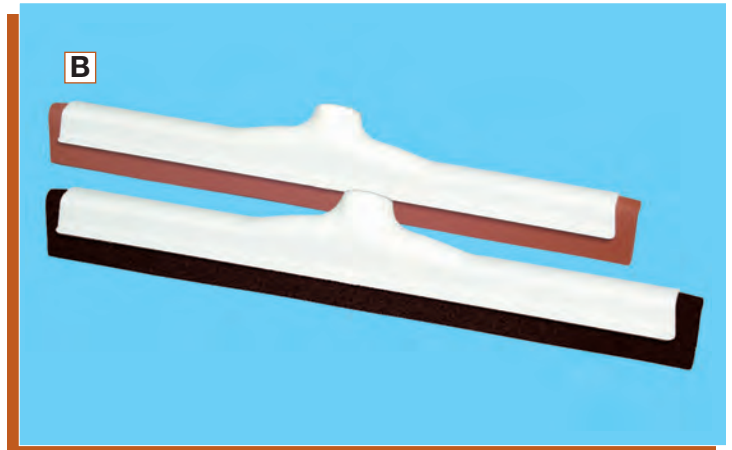

### C Brush Duro Moss Squeegee

- Same features as item "B"
- Fused bristles prevent bacterial build-up
- Brush and squeegee action in one cleaning tool
- Use on smooth, rough and tile floors

FPP18R	18"	Red	10/cs	7 lb
--------	-----	-----	-------	------

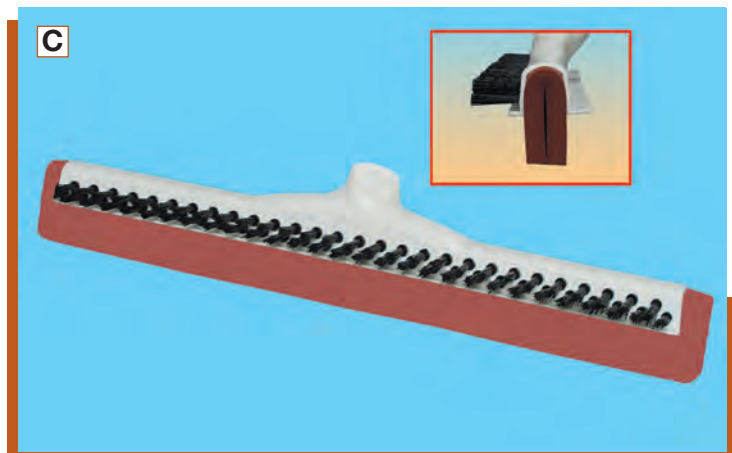

## Squeegees Handles

### D Floor Squeegee Handles

#### 1 1/8" Diameter Tapered Handles

221W	Wood	54" Length	12/cs	15 lb
------	------	------------	-------	-------

### E Fluted Aluminum Tapered Handle

9050	1 5/16" Dia.	56" Length	10/cs	10 lb
------	--------------	------------	-------	-------

### F Fluted Aluminum Handle with Threaded Tip

- Sturdy, fluted aluminum handle with rubber grip

9051	1 5/16" Dia.	58" Length	10/cs	9 lb
------	--------------	------------	-------	------

For more handle options, see page 58

❖ Non-stocked item requires special order





## Floor Scrapers

### A Heavy-Duty Floor Scrapers

- Double edge blades – dull and razor sharp
- Perfect for removing tape, gum and grit from floors
- Reduces back and knee strain
- 4" angled head

2007	48" Handle	6/cs	9.0 lb
6009	4" Replacement Blades	10/pk	0.1 lb

### B Heavy Duty Floor Scrapers

- Heavy duty, light weight aluminum handle
- Carbon and steel blade comes with razor sharp and blunt edges
- Perfect for removing gum, tape and grit

8006	4" Blade, 12" L	6/cs	2.4 lb
8007	4" Blade, 9" L	6/cs	2.4 lb
6009	Replacement Blades	10/pk	0.1 lb



### C Floor & Wall Scraper

- Flexible, high carbon steel blade and durable handle
- Moulded handle with non-slip, ergonomic grip

860	1½" Blade	24/cs	3 lb
-----	-----------	-------	------

### D 4" Light Duty Scraper

- For light duty jobs
- Lightweight, aluminum 48" long, 0.83" diameter handle with ergonomic grip and hanging hole
- 4" angled zinc alloy head removes gum, stickers and wax build-up

LH12C	48" Handle	10/cs	10 lb
6009	Replacement Blades	10/pk	0.1 lb



### E 8" Heavy Duty Scraper (Telescopic)

- For heavy duty jobs
- Telescopic steel handle, extends from 3 to 5 feet
- 1.13" diameter galvanized steel handle with ergonomic grip
- 8" angled zinc alloy head for stripping tile floors, removing carpets and heavy-duty adhesives

HDSO	3' to 5'	5/cs	10 lb
HDSBO	Replacement Blades (10/pk)	5 pk/cs	1 lb

### F ErgoTec® Scraper

- Comfortable ergonomic scraper with non-slip bi-component rubber grip
- Reversible tempered 4" carbon steel blade has blunt edge for cement or stucco work
- A razor edge for scraping paint and tape
- Handle easily attaches to all Unger poles, new ergonomic grip
- Comes with protective cap for blade

SH00C	6" Handle	10/cs	3.5 lb
6009	4" Replacement Blade	10/pk	0.1 lb



# Mopping Equipment



## Combo Packs

- Fits most janitor carts (see page 136)
- Buckets and wringers can be purchased separately
- For replacement plastic buckets or wringers, see Parts List

### A Splash Guard Combo Packs-Side Squeeze

- Wringer and bucket are balanced and bail handle allows lifting, even with the wringer in place
- International caution symbol stamped on bucket
- Dimensions: 21" L x 18½" W x 37¾" H

<b>335-312YE</b>	Yellow	35 qt	1/cs	25 lb
<b>335-312BL</b> ♦	Blue	35 qt	1/cs	25 lb
<b>226-312YE</b>	Yellow	26 qt	1/cs	23 lb
<b>226-312BL</b> ♦	Blue	26 qt	1/cs	23 lb

### B 6000/2635 Combo Packs

- Wringer fits inside the bucket for economical shipment
- Moulded from high impact structural foam polyethylene for durability and corrosion resistance
- Dimensions: 24" L x 16" W x 32" H

<b>6000/2635YE</b>	Yellow	26 - 35 qt	1/cs	21 lb
<b>6000/2635GY</b>	Grey	26 - 35 qt	1/cs	21 lb

### C Side Squeeze Combo Pack

- 35 qt Bucket with Side Squeeze Wringer
- Trilingual caution symbol (English/French/Spanish)
- 3" casters

<b>8001YE</b>	Yellow	35 qt	1/cs	17 lb
---------------	--------	-------	------	-------

### D Splash Guard Combo Packs-Down Press

- International caution symbol stamped on bucket
- Dimensions: 21" L x 18" W x 35" H

<b>335-37YE</b>	Yellow	35 qt	1/cs	23 lb
<b>335-37BL</b> ♦	Blue	35 qt	1/cs	23 lb

### E Never Lift Bucket

- Comes with 3" non-marking double race ball bearing casters; accepts all wringers
- Offers the largest capacity size in the industry (46 quarts)
- Ergonomically designed to eliminate back injuries
- Patented adjustable drain valve regulates water flow to accommodate any floor drain and allows no-lift emptying
- Removable strainer collects large debris
- Moulded from high impact structurally foamed polyethylene for durability and corrosion resistance
- Dimensions: 24" L x 17" W x 18" H

<b>460GY</b>	Grey	46 qt	1/cs	17 lb
--------------	------	-------	------	-------

### F Never Lift Fill Hose

- Easily moves water from faucet to bucket or container
- Extra heavy-duty hose comes with socket fitting

<b>460H</b>	53" Length	Sold ea	1 lb
-------------	------------	---------	------

### G Plastic Down Pressure Wringer

- Fibreglass reinforced nylon gear and rack drive for increased wringing strength
- Injection molded polypropylene wringer
- Accommodates 16 - 40 oz mops

<b>4000GY</b>	Grey	Sold ea	11.5 lb
---------------	------	---------	---------

♦ Non-stocked item requires special order

## Galvanized Buckets & Wringers

- Constructed from high quality, electroplated cold rolled steel
- The strongest, longest lasting wringers available in the world
- Heavy-duty and extremely durable

### A Squeeze Wringers

- Superior, large angle linkage system allows maximum force throughout the wringing cycle
- Two piece tubular steel handle and solid  $\frac{5}{8}$ " square shaft put the handle closer to the wringer for more squeezing pressure than any other side pressure wringer
- Fully vented with large drain openings on all sides
- Large hopper squeezes more water out of any size mop
- Hopper capacity 422 cu. in.

2000	20-32 oz Mops	1/cs	16 lb
------	---------------	------	-------

### B Gear Down Pressure Wringers

- Eccentric gearing system forces pressure pads straight down on the mop for easy, no splash wringing
- Designed to make mop wringing easier and faster

91021	8 - 16 oz Mops	1/cs	10 lb
91010	16 - 24 oz Mops	1/cs	18 lb
91015	24 - 32 oz Mops	1/cs	20 lb

### C Oval Buckets - Galvanized Metal

- Constructed of 24 gauge mill-galvanized steel
- Top reinforced with  $\frac{1}{4}$ " steel wire rim
- Heavy corrugations give bucket extra strength
- Embossed, permanent graduations for easy measuring
- Comes with 2" double ball bearing casters for easy transport

260	26 qt	1/cs	11 lb
350	35 qt	1/cs	12 lb

### D Metal Wring Easy

- Use with a yacht mop for a very efficient mopping unit
- Place mop in cone, press down and turn to wring water out
- 2 gal.; accepts 8 oz mops
- Dimensions:  $7\frac{1}{2}$ " L x  $10\frac{1}{4}$ " W x  $10\frac{1}{2}$ " H

20143	2 gal	6/cs	22 lb
-------	-------	------	-------

### E Rectangular Pail with Wringer

- Rectangular shape easily accepts other cleaning tools such as sponge mops; Pail only available - **See page 44**

800	15 qt	Blue	6/cs	18 lb
-----	-------	------	------	-------

## Mopping Tanks

### F Mopping Tanks

- Constructed of heavy-duty galvanized and painted cold rolled welded steel
- Comes with two-roller wringer (one rubber, one corrugated steel)
- Specially designed spring; easily adjusts pressure on the mop
- Brass drain never corrodes or clogs
- Comes with two compartments and a vinyl bumper
- Outer Dimensions for 250B: 40" L x  $20\frac{1}{2}$ " W x  $32\frac{1}{2}$ " H
- Dimensions for 300B: 45" L x 23" W x 33" H
- Dimensions for 600B: 49" L x 25" W x 39" H

250B	Galvanized	12½ gal	Sold ea	131 lb
300B	Galvanized	15 gal	Sold ea	157 lb
600B	Galvanized	30 gal	Sold ea	180 lb
369	Repl. Wringer - Fits all Models		1/cs	26 lb

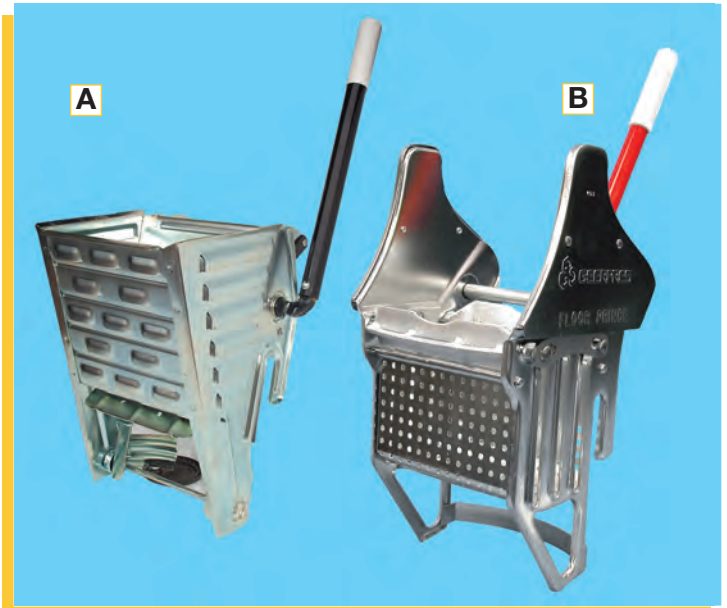



## Microfibre Flat Mop Systems



### A The Mopster™

- Complete system includes 18" hook-and-loop frame, 32 oz dispensing bottle and 54" handle
- Hook-and-loop frame is moulded vs. attached with glue or rivets
- Removable dispensing bottle features a wide opening for easy filling and cleanout smooth operation
- Translucent, graduated dispensing bottle identifies fill level in both ounces and millilitres
- Durable, ultra-light construction reduces user fatigue
- Ergonomic, end-of-handle thermoplastic rubber ball swivels for smooth operation
- Eliminates waste water completely, reducing water usage
- Saves on chemicals by using only what you need
- Saves labour involved in filling buckets and wringing out mops
- Viton Seals ensure confident operation with a variety of heavy duty chemicals
- All-Stop ball valve ensures a positive on and off flow control unlike competitors' pinch valves
- **See page 52** for mop pads
- Larger frames and mop pads available upon request

<b>LBH18</b>	Complete	1/cs	4.0 lb
<b>LBH18B</b>	Extra 32 oz Bottle	1/cs	0.2 lb

### B The Mopster™ ProPack Complete Floor Care System

- An all-purpose backpack system that works perfectly with The Mopster™ microfibre bucketless mopping system
- The Mopster™ ProPack expands the capacity of The Mopster™ by six times; adding comfort, utility and allows the user to complete jobs faster using less chemicals
- Ideal for schools, hospitals, Big Box Retail and Grocery Stores, Building Service Contractors, Arenas/Stadiums, Movie Theaters
- Uses up to 39% less floor finish and 80% less damp mop solution than bucket and wringer
- Can cover up to 6,000 square feet per hour
- Saves labor involved in filling, cleaning and wringing
- Shorter drying times reduce risk of slip and fall injuries
- All unused chemicals remain in the self-sealing bag, reducing the risk of exposing the worker to any harmful chemicals

<b>LBH18BPK</b>	Mopster™ ProPack	1/cs	2.8 lb
-----------------	------------------	------	--------

### C Chemical Storage Bags

- Keep extra bags on hand to allow the use of different chemicals and finish
- Bags can store chemicals for up to 6 months

<b>LBH18CSB</b>	Chemical Storage Bags	175/cs	5 lb
-----------------	-----------------------	--------	------

### D Utility Belt

- Padded, vented and adjustable
- Eight storage pockets that give the operator places to store items such as disposable gloves, shoe covers, microfibre cloths, keys, safety glasses, etc.
- Removable two-compartment liner in pouch keeps clean and dirty mops separated

<b>LBH18UB</b>	Utility Belt	6/cs	24 lb
----------------	--------------	------	-------

### E Bag Filling Station

- Allows easy filling Chemical Storage Bags (LBH18CSB) from 5 gallon pails and popular bag-in-box chemical containers

<b>LBH18BFS</b>	Filling Station for 5 gal pails	1/cs	3 lb
-----------------	---------------------------------	------	------



## Microfibre Flat Mop Systems

### A Microfibre Damp Mops

- Durable, low abrasive wet pads for general use
- Multiple layers of microfibre for greater absorbency; no foam

<b>LF0011</b>	Blue Wet Mop - 18"	12/pk	2.5 lb
<b>LF0012</b>	Green Wet Mop- 18"	12/pk	2.5 lb

### B Deep Cleaning Microfibre Mops

- Polypropylene scrubbing strips for better deep grout line cleaning
- Feature an additional layer of microfibre for fluid retention versus a layer of foam for more bacteria resistance
- Excellent launderability
- Available in four colours for coding systems

<b>LWBS18</b>	18" Blue	12/pk	2.7 lb
<b>LWYS18</b>	18" Yellow	12/pk	2.7 lb
<b>LWGS18</b>	18" Green	12/pk	2.7 lb
<b>LWRS18</b>	18" Red	12/pk	2.7 lb

### C Disposable Flat Mops

- Perfect for those wanting to use microfibre without laundry access
- Excellent for an effective disposable cleaning system
- Works great wet or dry

<b>DISP18</b>	White, Unfinished Edge - 18"	50/bg	2.5 lb
<b>LBH18DISP</b>	Orange, Finished Edge - 18"	50/bg	2.5 lb

### D White Trapezoid Finish Mop

- Features looped and microfibre for better release of finish
- Two layers of microfibre for better absorption with a Velcro® back

<b>LFFV18</b>	18" White	12/pk	2.0 lb
---------------	-----------	-------	--------

### E Microfibre Finish Mop with Blue Stripes

- Trapezoid shape for easy application in corners
- Blue microfibre strips are more rigid and help smooth finish
- Top quality hook and loop backing
- Specially designed to hold and release finish for even coat

<b>3189</b>	18" White with Blue Stripes	12/pk	2.3 lb
-------------	-----------------------------	-------	--------

### F Hook and Loop Dust Mop

- Cut-end microfibre with fringe to pick up larger particles of dust and trash
- Poly/canvas backed microfibre mops attract and hold dust that cotton mops leave behind
- Attracts dust electrostatically and requires no treatment
- Extra padding in the mop allows for complete surface contact
- Velcro® backing, for use with microfibre bases

<b>LFFD18</b>	18" Grey/Blue	12/pk	3.9 lb
---------------	---------------	-------	--------

### G White Looped Microfibre Wet Mop

- Thick looped wet mop for heavy soils
- Versatile mop can be used for dry dusting, wet mopping and wall washing
- Large loops for larger soil capacity

<b>3177</b>	18" White	12/pk	2.3 lb
-------------	-----------	-------	--------

◆ Non-stocked item requires special order



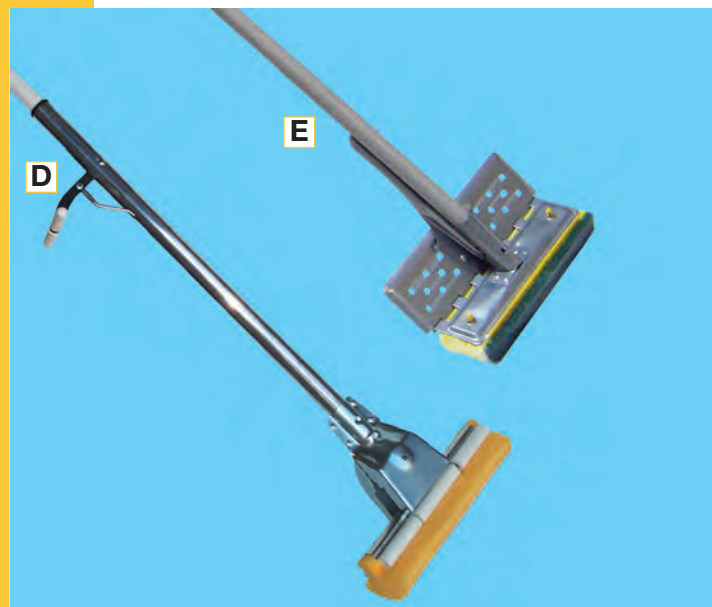

## Microfibre Flat Mop Systems

### A Pump-Style Microfibre Flat Mop

- Includes a 30 oz solution reservoir and plunger grip dispenser
- Made of durable, lightweight materials that are easy to use
- Includes two spray tips - spray mist tip for general cleaning and jet-stream for heavily soiled floors
- Handle and base plate constructed of aircraft grade aluminum for heavy-duty daily use
- Adjustable spray nozzle directs solution to hard-to-reach areas
- Features hang up hook, comfort soft grip and universal swivel head for easy manoeuvrability

<b>CSA130</b>	18" Blue	1/cs	2.5 lb
---------------	----------	------	--------

### B Trigger-Style Microfibre Flat Mop

- Designed for small businesses, offices, retail stores and households looking for professional results
- 30 oz solution reservoir and easy-to-use trigger grip dispenser
- Includes two spray tips - spray mist tip for general cleaning and jet-stream for heavily soiled floors
- Handle and base plate constructed of aircraft grade aluminum for heavy-duty daily use
- Adjustable spray nozzle directs solution to hard-to-reach areas
- Features hang up hook and universal swivel head for easy manoeuvrability

<b>CSA130TSP</b>	18" Red	1/cs	2.5 lb
------------------	---------	------	--------

For replacement flat mop heads for Item B & C, **see page 52**

### C Pro Spin Professional Spin Mop Bucket

- Unique spin handle and frame hinges 90° on each end
- Leave one end of the mop flipped to transform the mop holder into a specialty tool to clean baseboards, stairs, etc.
- Commercial grade 18" flat microfibre mop head can be machine laundered hundreds of times
- Place the mop in the basket, unlock the adjustment knob and move the handle up and down to spin the basket, drying the mop
- Safe to use; no foot pedal to spin dry the mop
- Includes four swivel casters for easy manoeuvrability and transportation to and from the filling station

<b>1080</b>	Pro Spin Complete	1/cs	6.6 lb
<b>1081</b>	Repl. Microfibre Mop	2/pk	0.2 lb
<b>1082</b>	Mop Handle Only	1/cs	1.3 lb

## Sponge Mops

### D Clean Machine Sponge Mop

- 9" wide heavy-duty roller sponge mop provides maximum absorption
- Convenient handle-mounted lever allows efficient roller wringing and eliminates the need for bending
- Plated metal construction and plastic rollers assure long service

<b>68</b>	51" Overall Length	12/cs	27 lb
<b>68R</b>	Sponge Refill	12/cs	4 lb

- Optional premium cellulose sponge refills hold more water and last longer

<b>68C</b>	Cellulose Sponge Refill	12/cs	4 lb
------------	-------------------------	-------	------

### E Economy Sponge Mop with Scrub Strip

- Ideal for small clean up jobs; 1" metal handle
- Dimensions for **62R**: 8 3/4" W x 2" D

<b>62</b>	49" Overall Length	10/cs	13 lb
<b>62R</b>	Cellulose Sponge Refill	12/cs	2 lb

## Plastic Mop Handles

- Food service approved
- Injection moulded heads are completely rust and corrosion free
- 1" fibreglass handles won't warp or rot
- Comes with swivel hanger endcap

### A Easy Change

- A quick release, hands-free system
- Ideal for day-to-day cleaning
- Light weight, durable and economical

570	56" L	Yellow Fibreglass	12/cs	18 lb
572	62" L	Yellow Fibreglass	12/cs	18 lb

### B Lock N' Load Fibreglass Mop Sticks

- Just Lock N' Load and you're ready to go
- Features lightweight fibreglass handle
- Blue plastic head and black swivel hang-up grip

579	57" L	Blue Fibreglass	6/cs	6 lb
580	63" L	Blue Fibreglass	6/cs	6 lb

### C Janitor

- 7 7/8" wide, one piece solid orange head

95	64" L	Wood	12/cs	23 lb
91	58" L	Orange Fibreglass	12/cs	22 lb
94	64" L	Orange Fibreglass	12/cs	23 lb

### D Speed Change

- Hinged yoke speeds mop changes
- 7 7/8" wide orange head

80	63" L	Wood	12/cs	24 lb
81	57" L	Orange Fibreglass	12/cs	22 lb
84	63" L	Orange Fibreglass	12/cs	23 lb

## Metal Mop Handles

### E Lock N' Load Aluminum Mop Sticks

- Just Lock N' Load and you're ready to go
- Features lightweight aluminum handle
- Blue plastic head and grip

577	63" L	Aluminum	12/cs	12 lb
578	58" L	Aluminum	12/cs	12 lb

### F Quick Change

- Economical quick change 1 1/8" wood or 1" metal mop handle designed for both narrow and wide band mops of any size
- Extra large, heavy brass wing nut and sturdy screw clamp
- Constructed from heavy plated metal
- 7" wide head with double riveted socket
- Long lasting, rust resistant steel hardware

83	62" L	Wood	12/cs	32 lb
837	62" L	Black Metal	12/cs	32 lb

◆ Non-stocked item requires special order

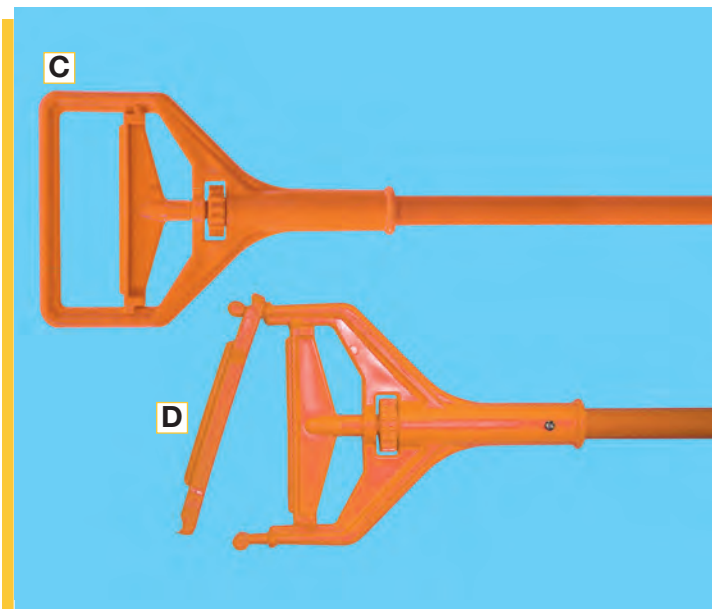



## Wet Mop Heads

- All wet mops are individually polybagged

### A Ranger

- Cotton industrial mop with 1½" four sewn white narrow headband provides quick pick up and is easy to wring out
- For daily maintenance of smooth tile, wood and concrete floors
- New mop must be wetted, wrung out and soaked for a minimum of 8 hours prior to initial use

<b>01020</b> ♦	12 oz/350 g	10/cs	8 lb
<b>01021</b>	16 oz/450 g	10/cs	11 lb
<b>01022</b>	20 oz/550 g	10/cs	14 lb
<b>01023</b>	24 oz/650 g	10/cs	16 lb
<b>01025</b> ♦	32 oz/850 g	10/cs	21 lb

### B Ace

- 100% synthetic, 4 ply yarns soak up to 6 times their own weight in water; narrow 1½" four sewn headband
- Use for cleaning and waxing
- Rinse with water and bleach to keep mop ultra clean and white in appearance
- Ready for use - no break-in required

<b>01040</b> ♦	12 oz/350 g	10/cs	8 lb
<b>01041</b>	16 oz/450 g	10/cs	11 lb
<b>01042</b>	20 oz/550 g	10/cs	14 lb
<b>01043</b>	24 oz/650 g	10/cs	16 lb
<b>01044</b> ♦	32 oz/850 g	10/cs	21 lb

### C Standard Blue Looped End Mops

- Narrow 1½" mesh headbands only
- Blue yarn is blended for superior performance, long life and good durability; ready for use - no break-in required
- High absorption, rapid pickup and wrings out easily
- Looped ends resist tangling, fraying and linting
- Withstands repeated launderings and maximizes usable life

<b>20126</b>	Small	10/cs	7 lb
<b>20127</b>	Medium	10/cs	9 lb
<b>20128</b> ♦	Large	10/cs	12 lb

## Yacht Mops

### D Cotton Yacht Mops

- 4 ply cotton, wire tied yarn is securely attached to a wood handle and provides long service

<b>YMC12</b>	48"	12 oz/350 g	10/pk	16 lb
<b>YMC16</b>	54"	16 oz/450 g	10/cs	20 lb
<b>YMC20</b> ♦	54"	20 oz/550 g	10/cs	22 lb

### E Synthetic Yacht Mops

- Blended yarns will not rot or mildew

<b>YMS12</b>	48"	12 oz/350 g	10/pk	16 lb
<b>YMS16</b>	54"	16 oz/450 g	10/cs	20 lb
<b>YMS20</b> ♦	54"	20 oz/550 g	10/cs	22 lb

- ♦ Non-stocked item requires special order

## Floor Finish Mops

### A Silky™ Finishing Mop

- Lint free finishing mop will leave floors streak free and with approximately 25% more shine
- Narrow band looped end construction gives Silky a longer life; allows mop to cover a larger floor area - leaves more finish on floor
- Recommended for use with Enviro Care® Novus Floor Finish shown on page 109

134615	16 oz	12/cs	12 lb
134616	20 oz	12/cs	14 lb

### B Rayon Looped End Finish Mop

- 4-ply blue and white striped rayon
- Durable 1¼" headband; tailband keeps the mop from tangling
- Ideal for floor finish

166121	Small	12/cs	10 lb
166122	Medium	12/cs	13 lb
166123	Large	12/cs	16 lb
166124	Extra Large	12/cs	21 lb

## Flat Finish Mops

### C Pro Loop Finish Flat Mop Refills

- Applies finish in a wide, smooth path
- Slip-on mesh backing; fits snap-on rigid frame (SO18)

#### Premium Monofilament Loop End Finish Mop

- Blue and white candy striped monofilament nylon yarn

09632	18" Length	10/cs	5 lb
-------	------------	-------	------

#### Standard Loop End Finish Mop

- Blue and white candy striped yarn

09602	18" Length	10/cs	5 lb
-------	------------	-------	------

## Wax Applicator

### D Wax Applicator

- Designed for smooth, lint-free application of floor finish, sealers and other liquid compounds
- Block accommodates standard threaded handles

137-16	16" x 4½" Block Only	10/cs	10 lb
--------	----------------------	-------	-------

#### Refills

138-16	16" Synthetic Refill	10/cs	3 lb
139-16	16" Lambswool Refill	10/cs	3 lb

**NOTE:** For handles, please see page 58

◆ Non-stocked item requires special order

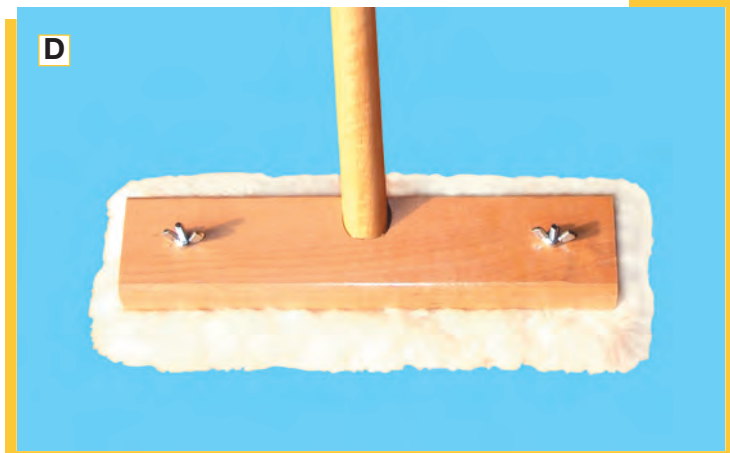



## THE MOST VERSATILE SYSTEM AVAILABLE!

**The Mopster™ Propack**, is an all purpose backpack system that works perfectly with **The Mopster™**, Impact's innovative microfiber bucketless mopping system.

### Benefits

- Saves \$\$ on chemicals by using only what you need
- Eliminates waste water completely
- Saves labor involved in fitting, cleaning, and wringing





# Brooms, Brushes & Accessories



## Push Brooms

**A**

**NEW!**



### **A** Tampico Medium Sweeping

- Black tampico 3" fibres
- Wire staple set into a natural hardwood block with two threaded handle holes
- Medium duty, non-brittle, natural fibre mix
- For general, all-around sweeping
- Quickly sweeps up heavy dirt
- This well-filled brush will leave no residue

<b>2818</b>	18"	5/cs	10.0 lb
<b>2824</b>	24"	5/cs	12.5 lb
<b>2836</b> ♦	36" with Broom Brace	5/cs	15.0 lb

**B**

**NEW!**



### **B** All Purpose Medium Sweeping

- Black and blue medium-stiff synthetic 3" fibres
- Hardwood block with two threaded handle holes
- Sweeps dust and mid-weight debris such as dirt, leaves and gravel
- Ideal for indoor/outdoor in dry conditions
- Durable and economical

<b>1618H</b>	18"	10/cs	24 lb
<b>1624H</b>	24"	10/cs	24 lb
<b>1636H</b>	36"	10/cs	26 lb

**C**

**NEW!**



### **C** Rough Commercial

- Blue stiff synthetic 3" fibres
- Hardwood block with two threaded handle holes
- Oil and chemical resistant
- Excellent for industrial applications

<b>2818H</b>	18"	10/cs	20 lb
<b>2824H</b>	24"	10/cs	20 lb
<b>2836H</b>	36"	10/cs	39 lb

### **D** All Purpose Fine Synthetic Push Broom

- All purpose floor sweep
- Soft fibres sweep fine debris such as dust, sand and wood shavings
- Perfect for indoor use under dry conditions; use in offices, warehouses and hospitals
- Split tip with 3" fine synthetic trim

<b>0818H</b>	18"	10/cs	16 lb
<b>0824H</b>	24"	10/cs	30 lb
<b>0836H</b>	36"	10/cs	35 lb

**D**

**E**



**NEW!**

## Push Broom Brace

- Provide extra handle support to reduce handle breakage common with heavy usage
- Metal construction provides excellent reinforcement
- Can be connected quickly and easily

### **E** Broom Brace

- Ideal for 24" to 36" push brooms

<b>3581</b>	Sold ea	0.5 lb
-------------	---------	--------

**NOTE:** For push broom handles, please see page 58

♦ Non-stocked item requires special order

## Cleaning Tool Handles & Holders

### A Fibreglass Handles with Threaded Tip

- Hanger cap; 1" Diameter
- Food service compliant

105-54YE	Yellow	54" Length	12/cs	11.5 lb
105-54BL	Blue	54" Length	12/cs	11.5 lb
105-60YE	Yellow	60" Length	12/cs	13 lb
105-60BL	Blue	60" Length	12/cs	13 lb

### B 7/8" Diameter without Threaded Tip

- Fits most moss metal squeegees (see pages 46 & 47)

8101	White	Fibreglass, 54" L	12/cs	16 lb
------	-------	-------------------	-------	-------

### C Fluted Aluminum Tapered Handle

9050	1 5/8" Dia.	56" Length	10/cs	10 lb
------	-------------	------------	-------	-------

### D Fluted Aluminum Handle with Threaded Tip

- Sturdy, fluted aluminum handle with rubber grip

9051	1 5/8" Dia.	58" Length	10/cs	9 lb
------	-------------	------------	-------	------

### E Lacquered with Acme Threaded Metal Tip

1554	7/8" Dia.	54" Length	12/cs	13 lb
1560	7/8" Dia.	60" Length	12/cs	14.5 lb

### F Lacquered with Acme Threaded Tip

1654	7/8" Dia.	54" Length	12/cs	10.5 lb
1660	7/8" Dia.	60" Length	12/cs	12.5 lb

### G 1 1/8" Diameter Tapered Handle

- Use with floor squeegees (see pages 46 & 47)

221W	Wood	54" Length	12/cs	15 lb
------	------	------------	-------	-------

### H Flow Thru Handle

- Easy access thumb action "flow control" lever

BH1700	Alum.	Extends to 56"	6/cs	7 lb
--------	-------	----------------	------	------

## Tool Holders

- Saves time and ends storage clutter; mounting screws supplied
- Holds mops, brooms and tools to free floor space

### I Tool Holder

- Holds tools with 7/8" to 1 1/4" diameter handles

515	Single	Sold ea	0.2 lb
-----	--------	---------	--------

### J Sure Grip Tool Holders

- Lock tools into place by pressing the handle against the Sure Grip Tool Holder - to remove the tool, just lift and it's unlocked!
- Holds 1 1/8" to 1 3/8" diameter handles

7045	Single	6/cs	1 lb
7047	3-Section, 18" Bar	12/cs	10 lb

### K Expandable Sure Grip Tool Holders

- Holds 1 1/8" to 2" diameter handles

7030	Single	6/cs	1 lb
7032	3-Section, 18" Bar	12/cs	12 lb

### L Utility Hooks

- Fits both the 7047 or 7032 Tool Holder Bars

5050	Short	12/cs	1 lb
5051	Long	12/cs	1 lb

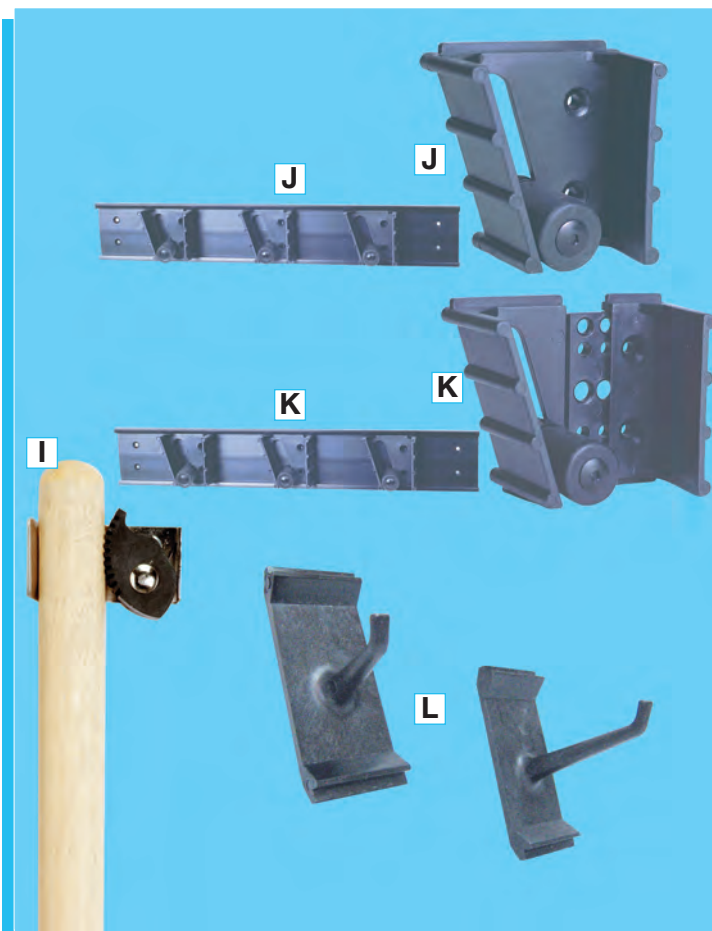



## Corn Brooms

### A 4001 Warehouse Workhorse Broom

- Constructed of corn and yucca fibres
- 5 string with a 7/8" diameter handle
- Designed for general use
- Excellent to use indoors and/or outdoors

4001	52" Overall Length	6/cs	10 lb
------	--------------------	------	-------

### B 4002 All Purpose Broom

- Choice quality, fully shouldered broom
- Broom constructed of a Corn and Rattan mixture
- 6 string construction with full sweeping tip
- Lacquered 1" handle

4002	56" Overall Length	12/pk	20 lb
------	--------------------	-------	-------

### C 4006 Warehouse Workhorse Broom

- Made of heavy corn exterior with a yucca centre
- 3 strings and a steel band construction
- Recommended for commercial or household use
- Excellent for fine to heavy debris
- 1" diameter handle

4006	56" Overall Length	6/cs	13 lb
------	--------------------	------	-------



## Synthetic Brooms

### D Clean Bee Broom

- Flagged, polypropylene, chemical resistant bristles
- Rotating end cap with hang up hole
- Yellow vinyl coated metal handle with foam ergonomic grip
- 16" wide broom head

2032	56" L	6/cs	12 lb
------	-------	------	-------

### E Large Angle Broom

- 12" wide flagged bristles pick-up fine dust
- Fully washable
- Angle cut for cleaning in hard-to-reach areas
- Sturdy, painted metal handle with hang-up grip
- Fibres are made from recycled pop bottles

458	54" Overall Length	10/cs	13 lb
-----	--------------------	-------	-------



### F Small Angle Broom

- Whisk feature is ideal for kitchen, bathrooms and foyers
- 9" sweep face
- Synthetic split-tip fibre
- Includes a 48" powder coated metal handle

455	54" Overall Length	10/cs	11 lb
-----	--------------------	-------	-------

### G Magnetic Broom

- 12" sweep face
- Designed to pick up fine dust and dirt with ease
- 3" Split-tip Synthetic bristles; comes with a 48" metal handle

453	52" Overall Length	10/cs	8 lb
-----	--------------------	-------	------

❖ Non-stocked item requires special order

## Scoop Hoops

### A Litter Scoop

- Large capacity collection bag for litter, trash or garden debris
- Black, powder-coated scoop frame
- Heavy-duty vinyl bag
- 15" wide opening for positive collection of litter
- 33" high handle designed to balance weight with minimum strain on the user's wrist
- Comfortable blue plastic handle grip reduces hand fatigue

<b>18H</b>	With Heavy-Duty Bag	4/bag	13 lb
<b>18HB</b>	Heavy-Duty Repl. Bag	12/cs	5 lb

### B Marathon® Scoop Hoop

- Scoop made of rugged tubular aluminum
- Light weight for reduced strain on user
- Durable clip-on woven nylon reinforced white fabrene bag
- Fabrene bag is replaceable at a modest cost
- 34" high with 12" wide opening

<b>17004</b>	Complete	20/cs	23 lb
<b>17006</b>	Without Bag	20/cs	17 lb
<b>17005</b>	Repl. Bags & Clips	12/cs	4.5 lb

### C NiftyNabber® Bagger

- Safe pickup and removal of trash
- Perfect for indoor and outdoor usage; Bagger collapses for compact shipping and storage
- Bottom drainage holes make rinsing out easy
- Can be pulled on the ground; less bending or lifting
- Uses standard 55 gallon trash bags
- Built-in handle makes emptying the Bagger easy

<b>NB300</b>	40 U.S. gal	1/cs	6 lb
--------------	-------------	------	------

## Litterpickers

### D Litter Grabber

- Innovative, multi-purpose tool
- Excellent for picking up bottles and debris
- Made of powder coated metal and features rubber over moulded steel fingers
- Powerful gear-driven claws grip small and odd shaped objects

<b>9070</b>	36"	10/cs	10 lb
-------------	-----	-------	-------

### E Reacher

- Stainless steel fingers will not rust; heat resistant to 500°F
- Strong sensitive fingers for extra wide grasp; 4-finger trigger
- Lift objects up to 5 lb and up to 4½" wide
- Nimble silicone cups are flexible enough to pick up items as small as a dime, yet strong enough to handle a large can of soup or box of cereal
- Comfortable pistol grip; pick up objects without twisting your wrist
- Satin finish aluminum is lightweight and strong

<b>4800</b>	32"	6/cs	6 lb
-------------	-----	------	------

**NOTE:** Other lengths available. Call to request information/pricing.

### F Trash Picker

- Simple but effective design
- Multiple "pick-ups" before clearing tip; safety guard included

<b>49042</b>	43"	6/cs	4.0 lb
<b>49549</b>	Replacement Tip	6/cs	0.5 lb





## Lobby Dust Pans

### A Combo Plastic Lobby Dust Pan with Angle Broom and Clip

- Handy clip allows a lobby broom to be attached right to the handle
- Easy lock 2-way PVC handle
- Innovative foot rest pads
- Enhanced angled bottom
- Re-engineered yoke, pan and feet
- Refined front edge
- Increased tray capacity
- New broom cleaning teeth on yoke
- Dimensions: 11" D x 12" W x 35" H

<b>67454</b>	Black	Complete	6/cs	17 lb
<b>2600C</b>	Black	Clip Only	6/bag	0.2 lb

### B Plastic Lobby Dust Pan

- Pan and handle features same as **67454** without clip and broom
- Dimensions: 11" D x 12" W x 37" H

<b>2600</b>	Black	6/cs	13 lb
<b>2600L</b>	L-Grip Coverter	6/bg	0.5 lb

### C Plastic Lobby Dust Pan with "L" Grip Handle

- Ergonomically designed "L" grip
- Pan and handle features same as **67454** without clip and broom
- Dimensions: 11" D x 12" W x 32" H

<b>2602</b>	Black	6/cs	14 lb
-------------	-------	------	-------

### D Deluxe Hooded Metal Lobby Dust Pan

- Self closing metal hood
- Large capacity 22 gauge steel body
- Powder-coated black finish for longer life
- Dimensions: 9 7/8" D x 12" W x 31 1/2" H

<b>64</b>	Black	6/cs	25 lb
-----------	-------	------	-------

### E Metal Lobby Dust Pan

- 12" wide, black enamel coated pan
- Chrome plated handle with hang-up slot
- Dimensions: 9" D x 12" W x 30 1/2" H

<b>65</b>	Black	6/cs	20 lb
-----------	-------	------	-------

## Lobby Brooms

### F Deluxe Angle Lobby Broom

- Medium sweep, plastic black fibre broom
- Generally used with a lobby dust pan or litter scoop
- Right angle cut with flagged ends to get into corners and pick up fine dust and dirt
- Black epoxy coated short steel handle

<b>454</b>	36 1/2" Overall Length	6/cs	4 lb
<b>454-20</b>	36 1/2" Overall Length	20/cs	14 lb

### G Toy Corn Lobby Broom

- 3 string construction
- Painted 7/8" handle
- Great tool for use with a lobby dust pan or the litter scoop

<b>4010</b>	38" Overall Length	10/cs	12 lb
-------------	--------------------	-------	-------

## Plastic Dust Pans

### A Plastic Dust Pans

- Moulded-in ridges allow for broom and counter brush cleaning
- Heavy-duty 12" dust pan
- Fine line edge for maximum pick up
- Dimensions: 12" D x 12" W x 4" H

700BK	Black	12/cs	7 lb
703RD	Red	12/cs	7 lb
701BL	Blue	12/cs	7 lb



## Clean Up Kit

### B Clean Up Kit

- Plastic dust pan and brush snaps together for easy storage
- Moulded-in ridges allow for counter brush cleaning
- Dimensions: 12½" L x 9" W x 4" D

175	Blue	10/pk	7 lb
-----	------	-------	------

## Metal Dust Pans

- Baked-on black enamel finish
- 20 gauge steel

### C 12" Metal Dust Pan

- Heavy-duty, one-piece construction
- Dimensions: 14" D x 12" W x 2 ¾" H

6	Black	12/cs	14 lb
---	-------	-------	-------

### D 16" Metal Dust Pan

- Heavy-duty, one-piece construction
- Dimensions: 15½" D x 16" W x 4 ¼" H

7	Black	12/cs	25 lb
---	-------	-------	-------

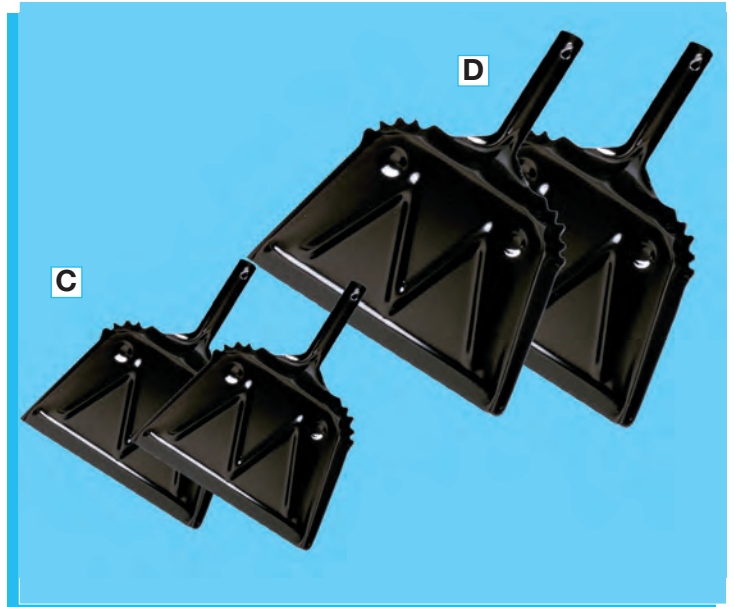

## Corn Whisk

### E 4014 Whisk

- 3 string construction
- Whisk constructed of a Corn and Rattan mixture
- Metal ring cap with hang-up ring

4014	11½" Overall Length	12/pk	6 lb
------	---------------------	-------	------



◆ Non-stocked item requires special order



## Utility Brushes

### A 10" Bi-Level Scrub Brush (Flow Thru)

- Constructed of a bi-level plastic block
- Design allows for three distinct washing angles
- Wash your vehicle, decks, pools and more
- Flow thru design; water will disperse through the brush head when used with a flow thru handle
- Dimensions: 10" L x 5" W x 4" H

<b>690</b>	Black Block/Yellow Fill	5/cs	4.5 lb
------------	-------------------------	------	--------

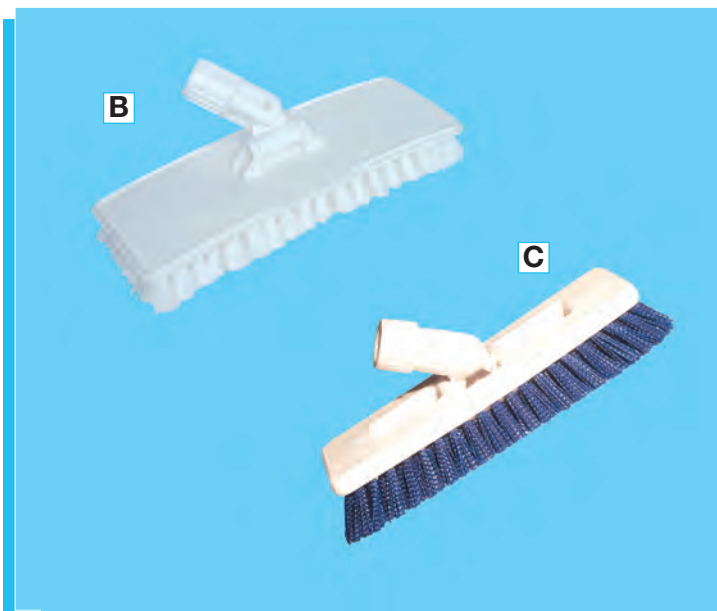

### B Swivel Scrub All with Fused Bristles

- Hygienically fused bristles
- A professional floor and wall tool that will reach anywhere
- Safe for use with most chemicals
- Comes with acme threaded connector
- Can be used with any 1" acme threaded handle
- Dimensions: 9½" L x 3½" W x 1" H

<b>SB100</b>	White Block/White Fill	36/cs	12.6 lb
--------------	------------------------	-------	---------

### C Swivel Scrub Brush

- Handles the toughest cleaning requirements
- Innovative universal joint allows brush to swivel and lock into any position
- Ideal for cleaning baseboards, under ledges, corners and hard-to-reach areas with a flick of the wrist
- Unique design and improved fill of Dupont Tynex "A" nylon
- Allows for aggressive scrubbing on most surfaces with extra long life (blue fill for general scrub)
- Can be used with up to 1" acme threaded or ¾" non-threaded handles
- Dimensions: 8" L x 3½" W x 1" H

<b>37000</b>	White Block/Blue Fill	6/cs	4 lb
--------------	-----------------------	------	------



### D Synthetic Scrub Brushes

- Synthetic fibres are chemical resistant
- Designed for medium to rough scrubbing
- Rigid, plastic block is strong and durable
- Designed for the most effective cleaning angle

<b>198</b>	9" Red	12/cs	3.2 lb
<b>199</b>	20" Red	6/cs	3.2 lb

### E Detail Brush

- 8" soft grip plastic handle with nylon bristles
- Ideal for cleaning small, hard-to-reach areas
- Excellent for a variety of cleanin applications, including grout cleaning

<b>562</b>	Black/Blue Bristles	48/cs	5 lb
------------	---------------------	-------	------

NOTE: For Handles, please see page 58

## Counter Top Brushes

### A Counter Top Brushes

- Structural foam, tan coloured block and coloured 2½" polypropylene fibre bristles
- Flagged bristles are ideal for coarse or fine dusting
- Handle has built-in hang up hole
- Dimensions: 8" brush face; 13" overall
- Fine/medium fill
- Most commonly used in the food service industry
- Ideal for sweeping flour, crumbs and powders, etc.

<b>1286R</b>	Tan Block/Red Fill	24/cs	5 lb
<b>1286B</b>	Tan Block/Blue Fill	24/cs	5 lb



## Scrub Brush

### B Scrub Brush

- Plastic handle with ¾" synthetic bristles
- The easy grip contour plastic handle protects hands from sharp pan edges and equipment
- 6" plastic block

<b>136</b>	White Block/White & Blue Fill	10/cs	3 lb
------------	-------------------------------	-------	------

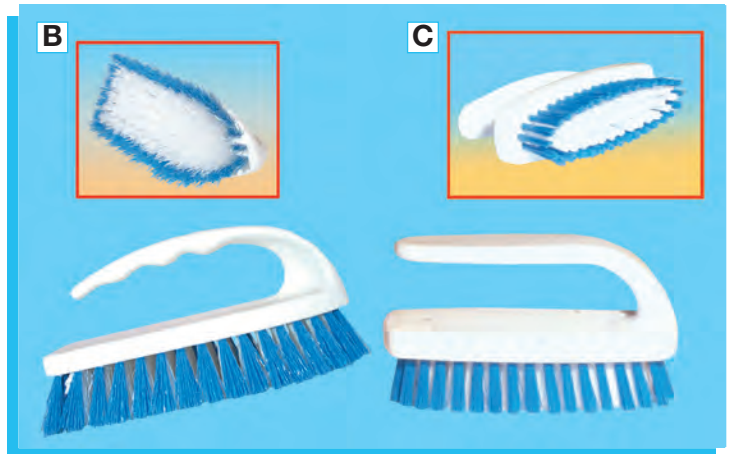

## Hand & Nail Brush

### C Hand and Nail Brush

- Plastic Block with handle and 4" x 1" scrubbing face
- Gentle, yet effective

<b>122</b>	White Block/White Fill	10/cs	1 lb
------------	------------------------	-------	------



## Deck Brushes

### D Deck Scrub Brush

- For cleaning of decks and similar wooden surfaces
- 10" wooden block with union fibre fill
- Can be used with any 1" acme threaded handle

<b>602</b>	Wood Block/Natural Fill	10/cs	10 lb
------------	-------------------------	-------	-------

### E Deck/Boat Scrub Brush (Flow Thru)

- 5" round flow thru scrub brush
- Ideal for scrubbing boats and decks
- Use a standard threaded, long tapered or flow thru handle
- Flow thru design; water will disperse through the brush head when used with a flow thru handle
- Dimensions: 5" dia. x 4½" H

<b>648</b>	Yellow Plastic Fibres	10/cs	9 lb
<b>653</b>	Tampico Fibres	10/cs	9 lb



**NOTE:** For Handles, please see page 58

❖ Non-stocked item requires special order





## Tile & Grout Brushes

### A Grout Brush

- This unique grout line scrubbing tool with stiff polyester trim chiselled to a point scrubs even the narrowest of grout lines
- Its tough construction features a swivel handle for flexible scrubbing action in tight surroundings
- Dimensions: 9½" L x 1¾" W x 2" H

3200	White Handle/Black Fill	12/cs	4 lb
------	-------------------------	-------	------

### B Tile and Grout Brush

- Cleans hard-to-reach areas
- Two rows of chemical resistant nylon bristles with 1/16" trim
- Ergonomic plastic handle with built-in hang up hole

32900	White & Blue Handle/Black Fill	10/cs	2 lb
-------	--------------------------------	-------	------



## Tile & Grout Repair

### Grout-Aide® Grout & Tile Applicators

- Covers grout, mold and mildew stains
- Change the colour of your grout
- Permanent on most surfaces
- Non-toxic, water resistant
- Odourless, no ventilation required
- Surfaces safe for children and pets

### C Grout-Aide® 4 oz Contractor's pack

- Covers up to 1,050 linear feet or 210 square feet of average grout lines
- Contractor's pack comes with two tips: A reversible fibre tip for thin grout lines and a flat head for wide grout lines
- Comes with 2 replacement fibre nibs

05550	White	4 oz/118 mL	6/cs	4 lb
05551	Grey	4 oz/118 mL	6/cs	4 lb
05552	Buff	4 oz/118 mL	6/cs	4 lb



### D Grout-Aide® ¼ oz Fibre Tip Marker

- Covers up to 175 linear feet of average grout lines
- Non-slip comfort grip
- Reversible fibre nib

05030	White	¼ oz/7.4 mL	72/cs	7 lb
05031	Grey	¼ oz/7.4 mL	72/cs	7 lb
05032	Buff	¼ oz/7.4 mL	72/cs	7 lb

❖ Non-stocked item requires special order

## Lambswool Dusters

Manufactured from the finest quality Australian lambswool mounted on durable polypropylene handles. Our Lambswool dusters set a benchmark for quality and durability for the industry. The fine crimped wool fibres form an intricate network that actually picks up and holds the dust, ensuring the dust isn't flicked into the air to settle later. The large, thick 14" dusting head ensures fast, effective dusting for every purpose. Sized to suit every application. Clean in warm, soapy water.

### A Lambswool Duster

2028	28" (71 cm)	12/cs	14 lb
------	-------------	-------	-------

### B Extendable Lambswool Duster

2040	30" - 40" (76 - 101 cm)	12/cs	4 lb
------	-------------------------	-------	------

### C Flexible Head

- Designed for dusting around pipes, on high shelves or the top of fan blades
- Use it straight or bend it to suit your application
- Flexible 14" wool head comes with white acme 7/8" threaded socket
- Fits XP-1 plastic extension pole (sold separately) and all 7/8" threaded handles

FH1610	20" (50 cm)	12/cs	5.0 lb
XPFH1610	Flexible Head & Ext. Pole	6/cs	3.7 lb

### D Plastic Extension Pole

- Overall reach with FH1610 duster is 72"
- 7/8" acme threaded tip
- Can be used for other cleaning tools with same thread

XP-1	28" - 52" (71 - 132 cm)	Sold ea	0.2 lb
------	-------------------------	---------	--------



## Ostrich Feather Dusters

- Made exclusively from 100% natural ostrich feathers
- Designed to suit the needs of the janitorial trade
- The ideal tool for fast and efficient dust removal
- Natural oils and soft spines of ostrich feathers pick up and retain dust like no other feather
- Durable throughout years of use
- Soft and gentle, yet can be washed hundreds of times
- Can be easily cleaned - just shake, rinse under lukewarm water and air dry
- Feathers are a natural product; feather length and colour may vary

### E Deluxe

- 9½" lacquered hardwood handle

4630	20"	12/cs	3 lb
------	-----	-------	------

### F Econo

- 9" lacquered hardwood handle

4603	23"	12/cs	3 lb
4604	34"	12/cs	5 lb



❖ Non-stocked item requires special order

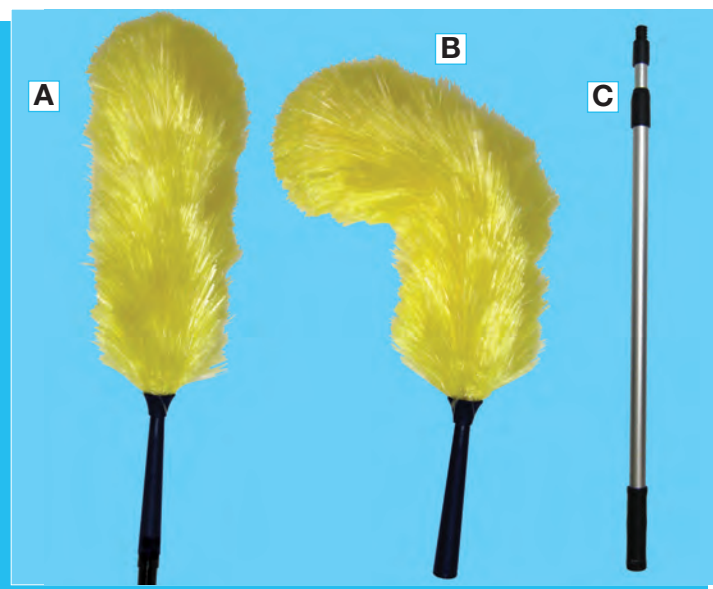

## Dusters & Tools

- Non-allergenic, polywool duster attracts dust by electrostatic action
- Designed for dusting around pipes, on high shelves, the top of fan blades and other hard-to-reach places
- Can be washed in warm water and mild detergent

### A Extended Polywool Duster

- 2-section extension pole with flexible duster head

<b>3125W</b>	52" - 80" (132 - 203 cm)	12/cs	10.5 lb
--------------	--------------------------	-------	---------

### B Polywool Duster Head

- Flexible head without extension pole

<b>3125H</b>	20" (50 cm)	12/cs	4 lb
--------------	-------------	-------	------

### C 2-Section Extension Pole

- Extension pole without flexible head
- 7/8" acme threaded tip
- Can be used for other cleaning tools with standard thread

<b>53165TH</b>	31 1/4" - 60" (79 - 152 cm)	12/cs	7 lb
----------------	-----------------------------	-------	------

### D EconoDuster

- Multi-coloured polywool duster with flexible head

<b>33125</b>	25" (65 cm)	12/cs	3 lb
--------------	-------------	-------	------

### E Extended EconoDuster

- 2-section extended polywool duster with flexible head

<b>30050</b>	31" - 43" (79 - 108 cm)	12/cs	4 lb
--------------	-------------------------	-------	------

### F Extendable Twist and Lock Microfibre Duster

- A great choice for dusting and cleaning
- Split strands grab and hold dirt and dust better than traditional dusters
- Reach harder areas like ceiling fans, shelves, and irregular surfaces
- Duster head is 100% microfibre; hand washable
- Safe to use on delicate items, will not scratch

<b>3148</b>	33" - 45" (84 - 114 cm)	12/cs	3.5 lb
-------------	-------------------------	-------	--------

### G Hand-Held Microfibre Duster

- Reach harder areas like ceiling fans, shelves, and irregular surfaces
- Duster head is 100% microfibre; hand washable
- Split strands grab and hold dirt and dust better than traditional dusters
- Safe to use on delicate items, will not scratch

<b>3149</b>	20"	12/cs	3.9 lb
-------------	-----	-------	--------

### H Microfibre Chenille Hi-Duster

- Soft fibre design (long fingers) allow for more effective dusting
- Flexible frame allows for effective dusting of hard-to-reach areas
- Snap-off handle can be replaced with #LFSO100 and #CHO246 handles for longer reach dusting

<b>LHDC</b>	Hi-Duster Complete	1/cs	1.3 lb
<b>LHDCVR</b>	Replacement Cover Green	12/bg	1.3 lb



# Waste Receptacles



## Efficient for Storage, Food Handling and Refuse Disposal

Containers meet and surpass all other heavy-duty plastic containers in every category. Moulded with the highest quality polyethylene resin. One-piece moulded construction creates high-impact and crush resistance.

With its lock-down lid, the container is animal and spill resistant; lid stays on even if container is tipped over. Offset ridge design allows container to nest without jamming. Handles have a larger radius and deeper well, making the container more comfortable to lift and move.

### Containers Without Lids

#### A 55 U.S. Gallon

- O.D. Dimensions: 33" Dia. x 26½" H
- Trash bag size: 42" x 48"
- Not NSF Approved

<b>775500GY</b>	Grey	3/bag	52 lb
-----------------	------	-------	-------

#### B 44 U.S. Gallon

- O.D. Dimensions: 23¾" Dia. x 31¾" H
- Trash bag size: 42" x 48"

<b>774444GY</b>	Grey	4/bag	53 lb
<b>774444YE</b>	Yellow	4/bag	53 lb
<b>774444WT</b>	White	4/bag	53 lb
<b>4444BL</b>	Blue (Plain)	4/bag	53 lb
<b>774444RD</b>	Red	4/bag	53 lb

#### C 32 U.S. Gallon

- O.D. Dimensions: 21¾" Dia. x 27½" H
- Trash bag size: 35" x 50"

<b>773200GY</b>	Grey	6/bag	56 lb
<b>773200YE</b>	Yellow	6/bag	56 lb
<b>773200WT</b>	White	6/bag	56 lb
<b>3200BL</b>	Blue (Plain)	6/bag	56 lb
<b>773200RD</b>	Red	6/bag	56 lb

#### D 20 U.S. Gallon

- O.D. Dimensions: 19¼" Dia. x 23½" H
- Trash bag size: 30" x 38"

<b>772000GY</b>	Grey	6/bag	36 lb
<b>772000WT</b>	White	6/bag	36 lb
<b>2000BL</b>	Blue (Plain)	6/bag	36 lb

#### E 10 U.S. Gallon

- O.D. Dimensions: 15¾" Dia. x 17" H
- Trash bag size: 26" x 36"

<b>771001GY</b>	Grey	6/bag	16 lb
<b>771001WT</b>	White	6/bag	16 lb

Blue containers with Mobius Loop available - see page 77



## Container Lids

- 4" Round Hole or 1½" x 9" Slot available in lids upon request

### 55 U.S. Gallon

- Dimensions: I.D. 26¾" - O.D. 27½" x 2½" H

<b>775501GY</b>	Grey	3/cs	12 lb
-----------------	------	------	-------

### 44 U.S. Gallon

- Dimensions: I.D. 24" - O.D. 26¼" x 1¾" H

<b>774500GY</b>	Grey	4/cs	11 lb
<b>774500YE</b>	Yellow	4/cs	11 lb
<b>774500WT</b>	White	4/cs	11 lb
<b>774500RD</b>	Red	4/cs	11 lb

### 32 U.S. Gallon

- Dimensions: I.D. 22" - O.D. 24¼" x 1¼" H

<b>773300GY</b>	Grey	6/cs	12 lb
<b>773300YE</b>	Yellow	6/cs	12 lb
<b>773300WT</b>	White	6/cs	12 lb
<b>773300RD</b>	Red	6/cs	12 lb

### 20 U.S. Gallon

- Dimensions: I.D. 19½" - O.D. 21¾" x 1½" H

<b>772100GY</b>	Grey	6/cs	9 lb
<b>772100WT</b>	White	6/cs	9 lb

### 10 U.S. Gallon

- Dimensions: I.D. 16¼" - O.D. 18½" x 1⅝" H

<b>771100GY</b>	Grey	6/cs	9 lb
<b>771100WT</b>	White	6/cs	9 lb

## Dome Top & Container Dolly

- Heavy-duty structural plastic
- Hinge & spring design keeps weather & pests out, odours in

### **A** 44 U.S. Gallon Plastic Dome Top

- Fits 44 gallon container or 55 gallon metal drum
- Dimensions: 24½" Dia. x 11¾" H

<b>4456GY</b>	Grey	2/cs	21 lb
<b>4456RD</b> <span style="color: green;">◆</span>	Red	2/cs	21 lb

### 32 U.S. Gallon Plastic Dome Top

- Fits 32 gallon container
- Dimensions: 22¼" Dia. x 11¼" H

<b>3232GY</b> <span style="color: green;">◆</span>	Grey	2/cs	19 lb
<b>3232RD</b> <span style="color: green;">◆</span>	Red	2/cs	19 lb

### **B** Container Dolly

- Five 3" swivel casters, extremely stable
- Securely attaches to all size units (except **771001**)
- Dolly fits competitor's Brute, Huskee & Gator containers
- Only dolly with vents to keep from suctioning to container
- Dimensions: 17⅞" Dia. x 6⅞" H

<b>8003</b>	Grey	2/cs	15 lb
-------------	------	------	-------

- **O.D.:** Outside diameter across handles
- For Recycling, see recycling section Pages 77 - 79



### Anchor Dolly



### **C** Anchor Dolly

- End-user design "Anchors" any model 32, 44 and 55 gallon container to prevent tipping
- 25% larger diameter than standard dollies for better centre of gravity
- Five 3" heavy-duty non-marking grey casters

<b>7708</b>	Black	2/cs	17 lb
-------------	-------	------	-------



## Container System Accessories

### A Portable Caddy - Bucket

- Organized cleaning system fits over rim and handle of 32, 44, and 55 gallon containers (including all competitors' models)
- Built-in features hold cleaning tools, scrapers, roll towels, plastic liners, gloves, cell phone, putty knives, sponges and more
- Take off the caddy/bucket and use unit as a portable cleaning or storage bucket
- Two deep compartments for wet or dry usage
- Dimensions: 15" L x 14" W x 14" H

1850	Blue/Grey	4/cs	12 lb
------	-----------	------	-------

### B Container Caddy

- Wraps around containers
- Water resistant
- Has nine pouches for cleaning supplies
- Fits 32, 44 and 55 gallon round containers, as well as 48 and 55 gallon square containers
- Dimensions: 22" W x 19½" H

7705	Yellow	6/cs	10 lb
------	--------	------	-------



### C Bumblebee Hook

- Securely holds tools on trash receptacle rim and protects them from the damage of typical transport
- Saves time; places everything conveniently at hand and reduces time lost moving items around to get the right tool
- Keeps tool handles away from waste so you are not touching contaminated surfaces

280280	Black/Yellow	12/cs	1 lb
--------	--------------	-------	------

## Galvanized Garbage Cans

- All galvanized garbage cans and lids are made of 30 gauge metal

### D 16½ Gallon Can

- Dimensions: 17" Dia. x 25" H

12143NL	76 L	Sold ea	7 lb
---------	------	---------	------

### E 20 Gallon Can

- Dimensions: 17" Dia. x 29" H

12153NL	91 L	Sold ea	7.3 lb
---------	------	---------	--------

### F 22 Gallon Can

- Dimensions: 18½" Dia. x 25" H

12163NL	100 L	Sold ea	7.6 lb
---------	-------	---------	--------

### G 17" Can Lid

- Dimensions: 17" Dia.
- Fits both the 12143NL and 12153NL

12143L	12/cs	18 lb
--------	-------	-------

### H 18½" Can Lid

- Dimensions: 18½" Dia.

12163L	12/cs	24 lb
--------	-------	-------

NOTE: Galvanized cans and lids are shown and sold separately

◆ Non-stocked item requires special order



## Indoor/Outdoor Containers

### A 45 U.S. Gallon Vanguard

- Moulded of structural plastic with UV inhibitors for strength and durability
- Impact, abrasion and corrosion resistant; won't rust or leak
- Receptacle with hinged top and doors
- Oversized doors are spring loaded
- Dimensions: 21¾" Sq. x 42" H
- Optional rigid plastic liner available (#6350)
- Rigid liner dimensions: 18¼" Sq. x 29¼" H
- Trash bag size: 42" x 48"

<b>8750BR</b>	170 L	Brown	1/cs	40 lb
---------------	-------	-------	------	-------

## Dome Top Containers

### B 21 U.S. Gallon Bullet Containers

- Moulded from structurally foamed polyethylene
- Units are rust and leak proof
- Balanced "light-touch" door hides refuse
- Dimensions: 18¼" Dia. x 40¾" H
- Trash bag size: 30" x 38"

<b>8870BE</b>	79 L	Beige	1/cs	25 lb
<b>8870BR</b>	79 L	Brown	1/cs	25 lb

### C 24 U.S. Gallon Roun'Top™ Waste Receptacle

- Contains no metal parts, making the container safe for secure areas in hospitals or prison systems
- Designed to contain and extinguish a fire
- Removable top allows easy access
- Weather-proof design allows for outside use
- Factory Mutual Approved

<b>1425BE</b> ♦	Beige	91 L	1/cs	24 lb
<b>1425BR</b> ♦	Brown	91 L	1/cs	24 lb

## Large Capacity Containers

### D 56 U.S. Gallon Colossus® Waste Receptacle

- Two spring-loaded doors keep waste hidden, odours in and pests out
- Dual vinyl-coated cable holds the lid in a vertical position for easy emptying and helps eliminate tipping the base
- Large capacity container accommodates bulky debris such as pizza boxes, etc.
- Factory Mutual Approved

<b>6562BE</b> ♦	212 L	Beige	1/cs	58 lb
<b>6562BR</b> ♦	212 L	Brown	1/cs	58 lb

♦ Non-stocked item requires special order

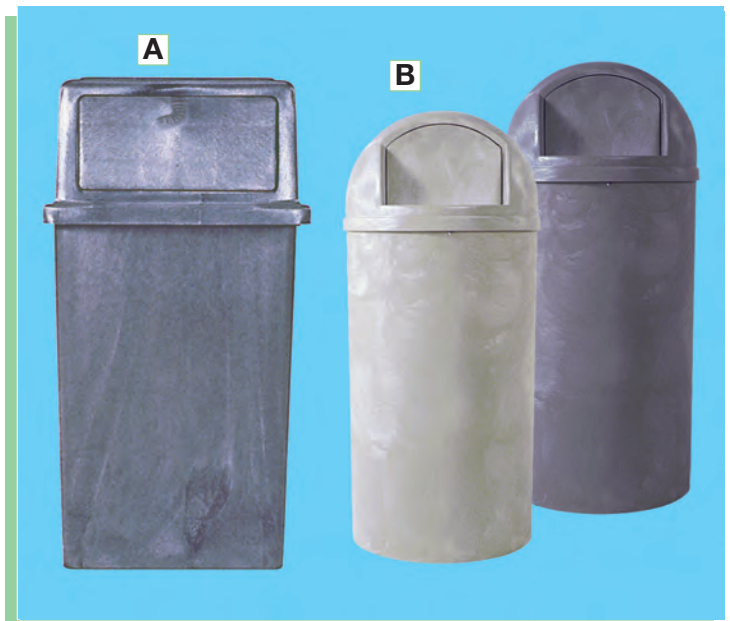



A



## A.R.C.™ Series Indoor/Outdoor Waste Receptacles

### A Free Standing Funnel Top

- All welded stainless steel construction with a super heavy-duty 18 gauge stainless steel funnel top
- Designed for use in high traffic areas such as airports, convention centres and arenas
- Comes with bag bracket holder apparatus for easy and secure support of plastic bags
- Dimensions 310S: 18" Dia. x 30" H
- Dimensions 310J: 21½" Dia. x 35½" H
- 8" diameter top inlet waste opening

<b>310S</b>	121 L/ 27.5 Imp. gal	1/cs	30 lb
<b>310J</b> ♦	206 L/ 45 Imp. gal	1/cs	43 lb

NOTE: Additional colours/finishes and polyethylene plastic liners are available on request. Contact your local representative for details.

## Swing Top Waste Receptacles

B



C



- 22 gauge cold rolled steel construction offers maximum fire protection with no openings on sides or bottom of unit
- All units include a standard bag holder apparatus

### Free Standing Swing Top Receptacles

- Rounded soft edge design; recessed feet elevate the unit
- Small and medium units fit under most counter tops

### B White Epoxy Finish

- Finished in hybrid epoxy polyester powder coat paint and black vinyl trim
- Dimensions for 300NL: 14¾" D x 13¾" W x 42" H
- Dimensions for 301NL: 14¾" D x 13¾" W x 34¾" H
- Dimensions for 302NL: 14¾" D x 13¾" W x 26¾" H

<b>300NL</b>	White	105 L/23 Imp gal	1/cs	27 lb
<b>301NL</b>	White	80 L/17.5 Imp gal	1/cs	23 lb
<b>302NL</b>	White	55 L/12 Imp gal	1/cs	19 lb

### C Stainless Steel Finish

- Dimensions: 14¾" D x 13¾" W x 34¾" H

<b>301NLS</b> ♦	SS	80 L/17.5 Imp gal	1/cs	23 lb
-----------------	----	-------------------	------	-------

### Optional Galvanized Metal Liners

- Optional lightweight 26 gauge galvanized steel liner

<b>300-500</b> ♦	Fits 300NL	Sold ea.	13 lb
<b>301-500</b> ♦	Fits 301NL & 301NLS	Sold ea.	12 lb
<b>302-500</b> ♦	Fits 302NL	Sold ea.	6 lb
<b>303-500</b> ♦	Fits 303NL	Sold ea.	7 lb

D



### D Wall Mounted Swing Top Receptacles

- White epoxy finish with black vinyl trim

#### Standard Wall Mounted Receptacle

- Designed to conserve floor space in light to medium-duty areas
- Dimensions: 8" D x 15¾" W x 33" H

<b>303NL</b>	White	50 L/11 Imp gal	1/cs	20 lb
<b>303-3NL</b> ♦	SS	50 L/11 Imp gal	1/cs	20 lb

#### Jumbo Wall Mounted Receptacle

- Designed to conserve floor space in medium to heavy-duty areas; trash bag replaces optional metal liner (not available)
- Dimensions: 8" D x 21¾" W x 39" H

<b>304NL</b> ♦	White	77 L/17 Imp gal	1/cs	27 lb
----------------	-------	-----------------	------	-------

## Thin Bins & Lids

### A 23 U.S. Gallon Thin Bin

- Constructed of durable polyethylene
- Textured finish outside for attractive, commercial look
- Polished inside for easy cleaning
- Convenient ergonomic handles
- Recessed handgrips moulded into bottom for easy emptying
- Shown with lids (sold separately)
- Dimensions: 23" L x 11" W x 30" H
- Trash bag size: 30" x 38"

<b>7023GY</b>	Grey	87 L	4/bag	26 lb
<b>7023BE</b>	Beige	87 L	4/bag	26 lb
<b>7023BL</b>	Blue	87 L	4/bag	26 lb

### B Flip Top Lid

- No touch lid with pivoting door allows hands free disposal of trash
- Hide unsightly refuse and can liner bags from view while giving easy access for emptying
- Fits 7023 containers
- Dimensions: 20¼" L x 11⅞" W x 4½" H

<b>7024GY</b>	Grey	4/cs	10 lb
<b>7024BE</b>	Beige	4/cs	10 lb

### C Thin Bin Lid with Round Cut Out

- Fits competitive units
- One round hole in blue lid for cans
- Made of 35% post consumer recycled material

<b>7025BL</b>	Blue with Round Hole	4/cs	4 lb
---------------	----------------------	------	------



## Bullseye Containers

### D Bullseye Receptacles

- This new material is complimentary in any upscale office or boardroom where a higher end product is preferred
- These containers are rotomoulded from durable polyethylene making them tough and impact resistant
- Dimensions: 34½" H x 11" W x 20½" D
- 16 Imp. gallons/73 L

<b>549AS</b>	Sandstone	Round Hole	1/cs	10 lb
<b>549BS</b>	Sandstone	Rectangular Slot	1/cs	10 lb
<b>549AG</b> ♦	Granite Grey	Round Hole	1/cs	10 lb
<b>549BG</b> ♦	Granite Grey	Rectangular Slot	1/cs	10 lb

### E Medium Bullseye Receptacles

- Dimensions: 24½" sq x 34" H
- 30 Imp. gallons/136 L

<b>559AS</b>	Sandstone	Round Hole	1/cs	10 lb
<b>559BS</b>	Sandstone	Sq. Opening	1/cs	10 lb
<b>559AG</b> ♦	Granite Grey	Round Hole	1/cs	10 lb
<b>559BG</b> ♦	Granite Grey	Sq. Opening	1/cs	10 lb

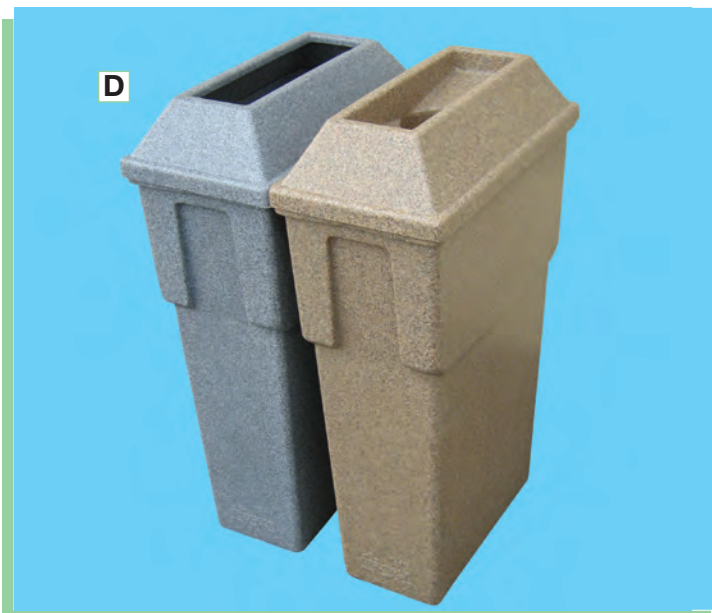

For Recycling, see pages 77 - 79

♦ Non-stocked item requires special order



## Step On Receptacles

### A Small Metal Step-On

- White baked enamel finish with plastic liner
- Dimensions: 11¼" D x 12¼" W x 18"

13200-1	White	17 L/18 Quart	1/cs	12 lb
---------	-------	---------------	------	-------

### B Large Metal Step-Ons

- Foot operated "flip top" allows hands-free operation in compliance with infection control regulations
- Nylon bag hooks hold poly bag in place
- Heavy gauge cold rolled steel with chip proof enamel
- A vinyl bumper and foam quiet stripping around lid
- Dimensions of 13300: 11½" Sq. x 22½" H
- Dimensions of 13400: 14" Sq. x 30" H

13300-1	White	49 L/13 US gal	1/cs	20 lb
13400-1	White	79 L/21 US gal	1/cs	30 lb



## Plastic Waste Receptacles

### C 13 L Plastic Swing Top Receptacle

- Great for tight spaces where a receptacle is a must
- Pivoting lid allows hands free disposal of trash
- Dimensions: 9⅞" sq. x 15⅞" H

8012GY	Grey	13 L	10/cs	12 lb
--------	------	------	-------	-------

### D 21 U.S. Gallon Half Round Wall Hugger

- Extra large top opening provides easy access
- Rounded front and sides allow use where other square or rectangular containers would interfere with traffic
- Reinforced base for commercial and institutional use
- Rolled top edge adds strength
- Dimensions: 12" L x 21¾" W x 28⅝" H
- Trash bag size: 30" x 38"

8321GY	Grey	79 L	2/cs	15.5 lb
8321BE	Beige	79 L	2/cs	15.5 lb



### E 25 U.S. Gallon Receptacle Base

- Fits 1600, 1700 or 1702 lid
- Dimensions: 16½" L x 16½" W x 26⅞" H
- Trash bag size: 30" x 38"

25GY	Grey	95 L	4/cs	33 lb
25BE	Beige	95 L	4/cs	33 lb
25BR	Brown	95 L	4/cs	33 lb

### F 32 U.S. Gallon Receptacle Base

- Fits 1600, 1700 or 1702 lid
- Dimensions: 16½" L x 16½" W x 31¼" H
- Trash bag size: 30" x 38"

32GY	Grey	121 L	4/cs	35 lb
32BE	Beige	121 L	4/cs	35 lb
32BR	Brown	121 L	4/cs	35 lb

◆ Non-stocked item requires special order

## Plastic Container Lids

### A 1600 Swing Top Lid

- Fits our 25 and 32 series containers
- Makes refuse disposal easy
- Peaked design is counter-weighted and automatically closes to hide trash
- Sloped surfaces discourage cigarette and waste accumulation
- Dimensions: 16½" L x 16½" W x 7⅞" H

<b>1600GY</b>	Grey	4/cs	12 lb
<b>1600BE</b> ♦	Beige	4/cs	12 lb
<b>1600BR</b> ♦	Brown	4/cs	12 lb

A

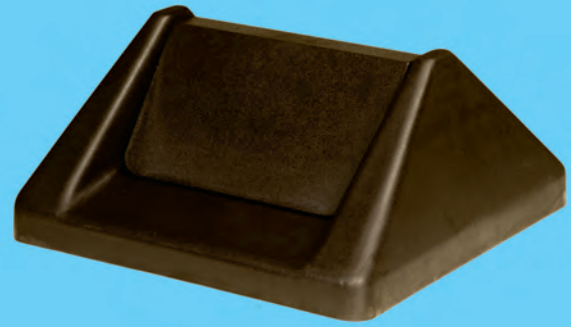

### B 1700 Tip Top Lid

- Fits our 25 and 32 series containers
- Gravity, hands-free opening encourages use and automatically closes to hide trash
- No metal parts to rust or break
- Dimensions: 16½" L x 16½" W x 5¼" H

<b>1700GY</b>	Grey	4/cs	12 lb
<b>1700BE</b> ♦	Beige	4/cs	12 lb
<b>1700BR</b> ♦	Brown	4/cs	12 lb

B



## Hungry Hobo Lids

### C Hungry Hobo

- A playful and colourful lid to fit on your waste receptacle indoors or out
- Helps encourage kids to keep waste/recycling in it's place
- Labels included (3 languages)
- Fits 55 US gal steel drums, 44 US gal plastic containers (as shown - sold separately) and 24" diameter or smaller bins
- Use in theme parks, arenas, fairgrounds, theatres, playgrounds, restaurants, ice cream shops, variety stores, arenas and more
- Dimensions: 25" Dia. x 28" H

<b>HHRD</b> ♦	Red	1/cs	15 lb
<b>HHYE</b> ♦	Yellow	1/cs	15 lb
<b>HHGR</b> ♦	Green	1/cs	15 lb
<b>HHBL</b> ♦	Blue	1/cs	15 lb

C



♦ Non-stocked item requires special order



## Metal Wastebaskets

- Manufactured from high quality steel with baked enamel finish
- Reinforced wire rims for extra strength

### A 14 U.S. qt. Round Wastebasket

- Dimensions: 11½" H x 8¼" Bottom Dia. x 11½" Top Dia.
- Trash bag size: 22" x 22"

1301GY	Grey	13 L	6/cs	12 lb
1301BK	Black	13 L	6/cs	12 lb

### B 28 U.S. qt. Round Wastebasket

- Dimensions: 14¼" H x 10¼" Bottom Dia. x 13½" Top Dia.
- Trash bag size: 24" x 22"

1302GY	Grey	27 L	6/cs	17 lb
1302BK	Black	27 L	6/cs	17 lb

### C 46 U.S. qt. Round Wastebasket

- Dimensions: 17" H x 12" Bottom Dia. x 15" Top Dia.
- Trash bag size: 26" x 22"

1303GY	Grey	44 L	3/cs	14 lb
1303BK	Black	44 L	3/cs	14 lb

### D 28 U.S. qt. Rectangular Wastebasket

- Manufactured from high quality steel with baked enamel finish
- Reinforced wire rims for extra strength;
- Complete with vinyl bumper to protect walls and furniture
- Dimensions: 7½" D x 14¾" W x 14½" H;
- Trash bag size: 24" x 22"

1304BK	Black	27 L	3/cs	14 lb
--------	-------	------	------	-------

## Plastic Wastebaskets

- Moulded of high quality polyethylene for strength and durability
- Seamless soft-sided construction will not dent or leak

### E 13⅝ U.S. qt. Small

- Dimensions: 11¼" D x 8" W x 12¼" H
- Trash bag size: 20" x 22"

1358GY	Grey	13 L	12/cs	15 lb
1358BK	Black	13 L	12/cs	15 lb
1358BE	Beige	13 L	12/cs	15 lb
1358BL	Recycle Blue	13 L	12/cs	15 lb

### F 28⅛ U.S. qt. Medium

- Dimensions: 14½" D x 10½" W x 15½" H
- Trash bag size: 20" x 22"

2818GY	Grey	13 L	12/cs	15 lb
2818BK	Black	13 L	12/cs	15 lb
2818BE	Beige	13 L	12/cs	15 lb
2818BL	Recycle Blue	13 L	12/cs	15 lb

### G 41⅛ U.S. qt. Large

- Dimensions: 15¼" D x 11" W x 20" H
- Trash bag size: 24" x 22"

4114GY	Grey	39 L	12/cs	35 lb
4114BK	Black	39 L	12/cs	35 lb
4114BE	Beige	39 L	12/cs	35 lb

1358BL & 2818BL Wastebaskets come with a bilingual Recycle Logo.  See page 77

## Recycling Containers

**NOTE:** All recycling containers are blue with white bilingual English/French recycling logo. All lids sold separately.

### **A** 20 U.S. Gallon

- O.D. Dimensions: 19¼" Dia. x 23½" H
- Trash bag size: 30" x 38"

<b>772000-1</b>	Recycle Blue	76 L	6/bag	36 lb
-----------------	--------------	------	-------	-------

### 32 U.S. Gallon

- O.D. Dimensions: 21¾" Dia. x 27½" H
- Trash bag size: 35" x 50"

<b>773200-1</b>	Recycle Blue	121 L	6/bag	56 lb
-----------------	--------------	-------	-------	-------

### 44 U.S. Gallon

- O.D. Dimensions: 23¾" Dia. x 31½" H
- Trash bag size: 42" x 48"

<b>774444-1</b>	Recycle Blue	167 L	4/bag	53 lb
-----------------	--------------	-------	-------	-------



## Recycling Container Lids

### **B** 20 U.S. Gallon

- Dimensions: I.D. 19½"; O.D. 21¾" x 1⅞" H

<b>772100WT</b>	White	6/cs	9 lb
-----------------	-------	------	------

### 32 U.S. Gallon

- Dimensions: I.D. 22"; O.D. 24¼" x 1¼" H

<b>773300WT</b>	White	6/cs	12 lb
-----------------	-------	------	-------

### 44 U.S. Gallon

- Dimensions: I.D. 24"; O.D. 26¼" x 1⅞" H

<b>774500WT</b>	White	4/cs	11 lb
-----------------	-------	------	-------

4" Round Hole or 1¼" x 9" Slot Available in Lids upon request.



### **C** Recycling Wastebaskets

- Dimensions for 1358BL: 11¼" L x 8¼" W x 12¼" H
- Dimensions for 2818BL: 14½" L x 10½" W x 15" H
- Trash bag size: 24" x 22"

<b>1358BL</b>	Blue	14 US qt/13 L	12/cs	15 lb
<b>2818BL</b>	Blue	28 US qt/27 L	12/cs	27 lb

## Tilt'n Wheel Container

### **D** 50 U.S. Gallon Tilt'n Wheel

- All purpose utility mobile container
- Hinged lid
- 189.25 litre capacity
- Dimensions: 27½" L x 23" W x 41" H

<b>5850-1</b>	Blue	2/cs	56 lb
---------------	------	------	-------



❖ **Non-stocked item requires special order**



## Separation Recycling Containers

- Containers designed for separation of recyclables
- Round holes or square holes for cans, 2 L bottles, paper, etc.
- Specify Recycling Decal, sold separately
- Durable and crack resistant, even under tough conditions

### A Bullseye

- Dimensions: 19¾" L x 10¾" W x 34" H
- Trash bag size: 30" x 38"
- 16 Imp. gallons/73 L

<b>549A</b>	Blue	Round Hole	1/cs	10 lb
<b>549B</b>	Blue	Rectangular Slot	1/cs	10 lb

**NOTE:** Sandstone and Granite Grey also available; see page 73

### B Half Moon Bullseye

- Unique contour design is ideal for use in tight spots
- Dimensions: 12¼" D x 22½" W x 36" H
- Trash bag size: 30" x 38"
- 15 Imp. gallons/68 L

<b>519A</b>	Blue	Round Hole	1/cs	10 lb
<b>519B</b>	Blue	Rectangular Slot	1/cs	10 lb

### C Medium Bullseye

- Dimensions: 20½" Sq. x 34" H
- Trash bag size: 42" x 48"
- 30 Imp. gallons/136 L

<b>559A</b>	Blue	Round Hole	1/cs	10 lb
<b>559B</b>	Blue	Square Hole	1/cs	10 lb

**NOTE:** Sandstone and Granite Grey also available; see page 73

### D Jumbo Bullseye

- Our largest bullseye, designed for recycling on a large quantity basis
- Comes with round hole and wasp flap in lid
- Dimensions: 24½" Sq. x 34" H
- Trash bag size: 42" x 48"
- 45 Imp. gallons/205 L

<b>108JB</b>	Blue	1/cs	22 lb
--------------	------	------	-------

### Recycling Decals

- Self-adhesive, weather resistant
- Bilingual - English/French

<b>01</b>	Round	5"
<b>02 - 07</b>	Oval	4" x 5¾"

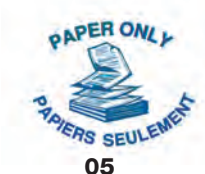

**NOTE:** ♦ All separation containers are also available in Grey by special order.

## Curbsider Collector

### **A Curbsider Collector**

- Full perimeter soft grip handle
- Mobius Loop on each end
- The handle design provides extra support strength to the container
- All container edges are rounded for additional strength and safety
- This CAD designed product has strategically located, reinforced ribbing integrated throughout the container that assures added strength, durability and long life
- Curbside bottom drainage system allows the retention of small amounts of liquid and drainage of rain water and melted snow
- Dimensions: 21" L x 15¼" W x 13" H

<b>BC14</b>	Blue	14 gal/53 L	Sold ea	4 lb
-------------	------	-------------	---------	------



## Under Desk Collector

### **B Under Desk Recycle Container**

- Deskside separation of waste and paper
- Space saver, fits under desk
- Holds legal and letter sized paper
- 1610 Saddle Tote fits inside or outside of all four Desk Tote walls
- Attractive design, engineered to fit together perfectly
- Made of tough, high density polyethylene
- Sold together or separately
- Dimensions: 12" L x 18" W x 7½" H

<b>1607</b>	17.4 L	Blue Tote Only	Sold ea	1.5 lb
-------------	--------	----------------	---------	--------



### **C Saddle Tote**

- Fits most metal and plastic rectangular waste baskets
- Fits competitor's square or round bins and baskets (sold separately)
- Attractive design; nestable
- Use to separate plastic and glass recyclables from paper
- Holds a full day's waste
- Dimensions: 9" D x 4½" W x 6½" H

<b>1610</b>	3.3 L	Black	Sold ea	0.5 lb
-------------	-------	-------	---------	--------

## Recycle Thin Bin

### **D 23 U.S. Gallon Blue Recycle Thin Bin**

- High capacity container designed for tight places
- Convenient ergonomic designed handles
- Recessed hand grips molded into bottom for easy emptying
- Textured finish outside for attractive, commercial look
- Smooth inside surface for easy cleaning
- Constructed of durable polyethylene blend
- Lid sold separately

<b>7023BL</b>	Blue	87 L	4/bag	26 lb
---------------	------	------	-------	-------

### **E Thin Bin Lid with Round Cut Out**

- Fits competitive units
- One round hole in blue lid for cans
- Made of 35% post consumer recycled material

<b>7025BL</b>	Blue with Round Hole	4/cs	4 lb
---------------	----------------------	------	------



❖ **Non-stocked item requires special order**





## Separation Recycling Containers

### A Bullseye Trio

- These recycling and source separation stations have quickly set the standard in the industry
- Combines recycling and/or waste disposal in one convenient station so you only have to invest in one unit
- High-end quality at a reasonable price
- Heavy-duty rotomoulded body construction will last for years
- Lockable lid
- Meets or exceeds the standard of 25% recycled materials
- Comes with three 25 imperial gallon liners
- Sheets of labels are included in every box to label it your way (English, Spanish & French)
- Two label spots for each hole
- Optional galvanized steel base with 5" swivel casters and stainless steel flaps for outdoor use available
- Dimensions: 54" L x 19" W x 38" H
- Trash bag size: 30" x 38"

<b>575BL</b> ♦	Blue	3 x 25 Imp gal	1/cs	90 lb
<b>575SS</b>	Sandstone	3 x 25 Imp gal	1/cs	90 lb
<b>575GG</b>	Granite Grey	3 x 25 Imp gal	1/cs	90 lb
<b>575BK</b> ♦	Black	3 x 25 Imp gal	1/cs	90 lb



### B Bullseye Duo

- Heavy-duty rotomoulded body construction will last for years
- Lockable lid
- Meets or exceeds the standard of 25% recycled materials
- Comes with two 25 imperial gallon liners
- Sheets of labels are included in every box to label it your way (English, Spanish & French)
- Two label spots for each hole
- Optional galvanized steel base with 5" swivel casters and stainless steel flaps for outdoor use available
- Dimensions 36" L x 19" W x 38" H
- Trash bag size: 30" x 38"

<b>565BL</b> ♦	Blue	3 x 25 Imp gal	1/cs	60 lb
<b>565SS</b>	Sandstone	3 x 25 Imp gal	1/cs	60 lb
<b>565GG</b>	Granite Grey	3 x 25 Imp gal	1/cs	60 lb
<b>565BK</b> ♦	Black	3 x 25 Imp gal	1/cs	60 lb

♦ Non-stocked item requires special order

## Separation Recycling Containers

### A Bullseye Triplet

- Smooth ergonomic design for easy cleaning
- Rotomoulded for extra strength and durability
- Minimum 25% recycled content (increases to over 70% for black base models)
- Customize your station in English, French or Spanish
- Attached hinged lid; top loading for easy disposal
- Three 16 imp. gallon liners included
- Dimensions: 47" x 17" x 28"; Trash Bag size: 26" x 36"

595SS	Sandstone	1/cs	60 lb
595GG	Granite Grey	1/cs	60 lb
595BK	Black	1/cs	60 lb
595BL	Blue	1/cs	60 lb
595SSBK	Sandstone & Black Base	1/cs	60 lb
595GGBK	Granite Grey & Black Base	1/cs	60 lb



### B Bullseye Twin

- Smooth ergonomic design for easy cleaning
- Minimum 25% recycled content (increases to over 70% for black base models)
- Customize your station in English, French or Spanish
- Attached hinged lid; top loading for easy disposal
- Two 16 imp. gallon liners included
- Dimensions: 33" x 17" x 28"; Trash Bag size: 26" x 36"

585SS	Sandstone	1/cs	60 lb
585GG	Granite Grey	1/cs	60 lb
585BK	Black	1/cs	60 lb
585BL	Blue	1/cs	60 lb
585SSBK	Sandstone & Black Base	1/cs	60 lb
585GGBK	Granite Grey & Black Base	1/cs	60 lb



## Outdoor Ash Receptacles

### C Heavy Duty Outdoor Ash Bins

- Heavy duty all stainless unit is ideal for pedestrian common areas
- 18 gauge stainless steel, 304, # 4 brushed finish
- Secured with tumbler keyed lock
- Door is hinged with full-length stainless steel piano hinge
- Offset mounting bracket keeps unit 5/8" away from wall
- Corrosion resistant galvanized steel (22 gauge) inner liner with baffle opening
- For unrestricted access, height of cigarette inlet to floor must not exceed 48" (121 cm)
- 908 is intended for use in less frequented areas
- 908 Dimensions: 7" L x 3" D x 9" H
- 909 Dimensions: 9" L x 5" D x 13" H

908	3 Holes	1/cs	4 lb
909	7 Holes	1/cs	11 lb
909-100	Smoke Station Pole	1/cs	17 lb



❖ Non-stocked item requires special order

## Plastic Outdoor Ash Containers

**A**

**ATTENTION  
BEST BUY**



### **A Cease-Fire® Outdoor Ash Container**

- Smokers Cease-Fire® innovative self-extinguishing design
- Made of flame-retardant, sturdy polyethylene, this low maintenance smoker's friend won't rust, dent, or crack
- Unique rain bonnet opening keeps rain out
- Simply lift off lid to empty big galvanized steel pail inside
- Tie-down notches offer security and greater stability under severe weather conditions
- In high humidity environments, unique "drip-lip" internal construction prevents tar condensation from escaping
- Factory Mutual fire tested and approved
- Dimensions: 16½" Dia. x 38½" H

<b>26800GY</b>	Grey	1/cs	15 lb
<b>26800BK</b>	Black	1/cs	15 lb
<b>26800BE</b>	Beige	1/cs	15 lb
<b>26800TC</b>	Terra Cotta	1/cs	15 lb
<b>26800GN</b>	Forest Green	1/cs	15 lb

### **B Elite Smoker's Cease-Fire® Outdoor Ash Container**

- Upscale styling enhances or complements any commercial architectural setting
- Collect unsightly cigarette litter and reduce the risk of fire
- Keep cigarette litter safely hidden from public view
- Fire tested and approved by FM Global
- No-rust polyethylene receptacle features a oxygen-restricting, self extinguishing design to safely collect burning butts
- Stainless steel snuffer screen reduces messy look and offers a fast, easy "snuff target" for cigarettes and cigars
- Limited entry design discourages unwanted trash from clogging the neck
- Larger snuff reduces the likelihood of your fingers contacting dirt and germs
- Covered opening eliminates messy rainwater overflow
- Mistake-proof opening/closure is self-aligning with no need for tools or hardware to loosen
- For added stability and weight simply add sand and/or use a brick in the specially designed base
- Optional padlock available
- New Eco Black is environmentally friendly - made from 75% recycled polyethylene
- Compact carton reduces packaging material, inventory space requirements and an average 34% cost savings on shipping

<b>268501GY</b>	Grey	1/cs	11 lb
<b>268502TN</b>	Tan	1/cs	11 lb
<b>268503BK</b>	Black	1/cs	11 lb

**B**



**C**



### **C Disposable Bucket Liner**

- For use in both the Smoker's Cease-Fire and the Elite Smoker's Cease-Fire
- Burn resistant
- Pack of Ten with twist ties
- Eliminates the need to "shake out" nasty butts
- When the liner is full, simply use the twist ties and discard it

<b>26827</b>	Disposable Bucket Liner	10/pk	1.5 lb
--------------	-------------------------	-------	--------

❖ **Non-stocked item requires special order**

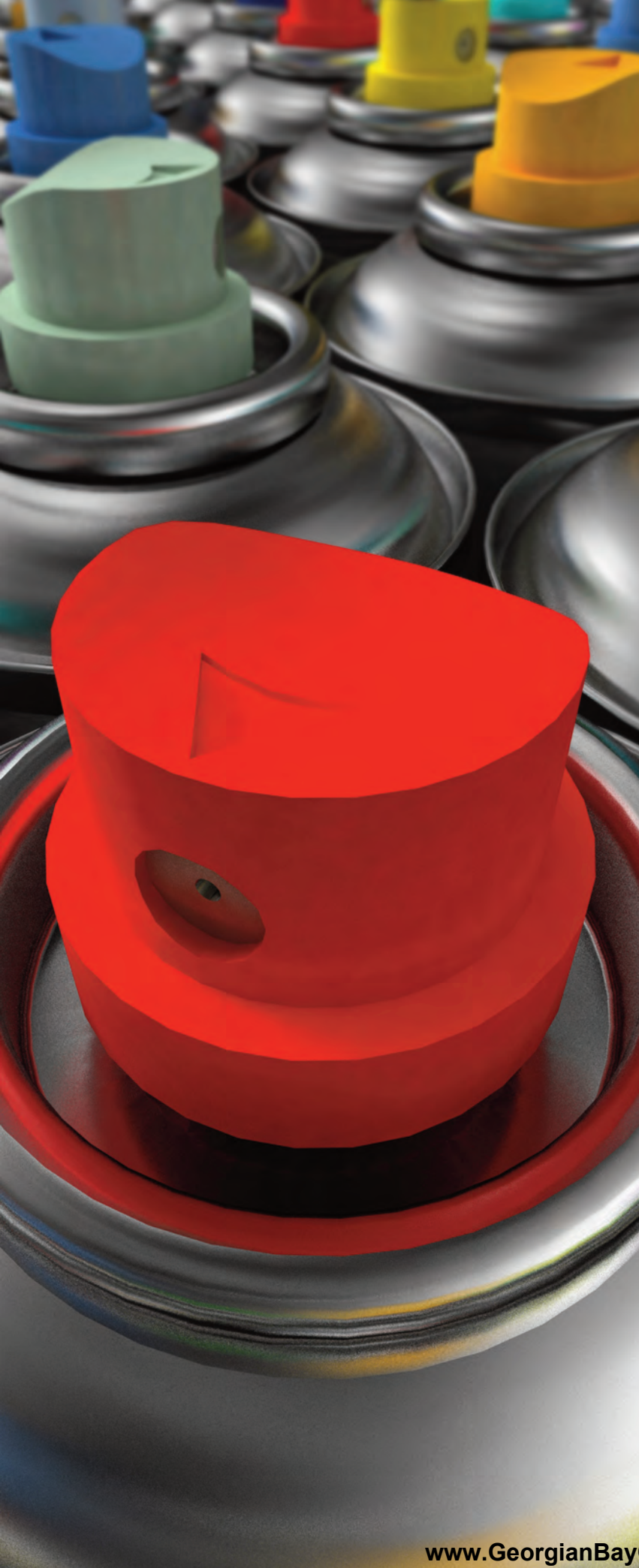

# Aerosols



A

## Cleaners

### A Glass Cleaner

- The most versatile glass cleaner available - cleans glass, windows, mirrors, windshields, enamel surfaces, chrome, tile, porcelain and other hard surfaces
- Dissolves dirt, grease, grit and grime
- Heavy-duty foam clings to vertical surfaces
- Guaranteed to leave no film
- Contains perfume-grade alcohol for best performance

SW050CC	net wt. 19 oz	12/cs	18 lb
---------	---------------	-------	-------

### B Orange Citrus Crazy Clean All Purpose Cleaner

- Formulated with a natural orange citrus solvent and emulsifiers that provide remarkable cleaning power on the heaviest of soils, greases, and oils
- Cleans and deodorizes surfaces on contact, safe to use where soap or detergents would be acceptable

985W	net wt. 19 oz	12/cs	18 lb
------	---------------	-------	-------



B



C

### C Baseboard Wax Stripper

- Specially formulated to serve the housekeeping professional where floor machines can't reach
- Penetrating foam easily removes soil and wax buildup from baseboards, floors, and ceramic wall tiles
- Quick and easy to use - adheres to vertical surfaces
- Cleans within minutes of application

857W	net wt. 19 oz	12/cs	18 lb
------	---------------	-------	-------

### D Granite & Marble Cleaner

- Heavy duty penetrating foam action
- Safely removes grease, oil, fingerprints, smudges, dirt and streaks
- Safe for use on sealed natural stone surfaces
- Use to clean or polish counter tops, vanity tops, tabletops, floors, etc.
- Fresh fragrance

SW702CC	net wt. 19 oz	12/cs	19 lb
---------	---------------	-------	-------



D



E



F

### E Grill and Oven Cleaner

- Cleans and shines cooking equipment in restaurants and other commercial establishments
- Efficiently cleans grills, rotisseries, stove burners, electric frying pans and other cookware resistant to caustics
- Formulated for use on porcelain, glass, ceramics, stainless steel and cast iron surfaces
- Not for use in self- or continuous-cleaning ovens

826W	net wt. 18 oz	12/cs	18 lb
------	---------------	-------	-------

### F Furniture Polish - Lemon Oil

- Designed for industrial and commercial use - anywhere wood and many other surfaces require special care
- Dusts, cleans and polishes in one step
- Removes stains, smudges and fingerprints
- Protects fine furniture, woodwork, Formica, plastic, chrome, marble, porcelain and leather
- Contains lemon oil

811W	net wt. 19 oz	12/cs	16.5 lb
------	---------------	-------	---------

## Disinfectants

### A Disinfectant Spray for Health Care

- Phenolic disinfectant and deodorant spray; an odour counteractant that chemically neutralizes malodours
- Kills most germs, including HIV-1 (AIDS Virus), Herpes Virus I and II, and Tubercule Bacilli (TB)
- Fungicidal (controls mould and mildew), bactericidal, staphylocidal, tuberculocidal, virucidal and pseudomonicidal to help stop the spread of diseases
- DIN #02246035

015DIN	net wt. 15.5 oz	12/cs	12 lb
--------	-----------------	-------	-------

### B Disinfectant Surface Cleaner

- Disinfects Influenza A2/Japan Virus and Herpes Simplex Virus Types 1 and 2 on hard, non-porous environmental surfaces
- Kills Pandemic 2009 H1N1 Influenza A Virus ("swine flu")
- Antibacterial, Bactericidal, Virucidal and Fungicidal
- Cleans and deodorizes; spray and wipe shining clean
- For use in homes, hospitals, nursing homes, medical facilities, businesses, hotels, motels, restaurants, schools, institutions and commercial establishments
- DIN #02246034

866DIN	net wt. 19 oz	12/cs	18 lb
--------	---------------	-------	-------



## Stain & Spot Removers

### C Dust Mop Treatment

- Makes the housekeeping and maintenance professional's job easier
- Improves dust pick-up on mops and cloths - does not "push the dust around"
- Coverts dust into a heavy lint for easy disposal
- Leaves no oily residue
- For use on unsealed wood, concrete and resilient floors

875W	net wt. 14 oz	12/cs	15 lb
------	---------------	-------	-------

### D Freeze Action Chewing Gum Remover

- Removes gummy substances, candle wax and putty
- The "freeze" action feature hardens the gum enough to easily remove from carpeting, fabrics, or hard surfaces
- New cherry fragrance

813W	net wt. 6.5 oz	12/cs	7 lb
------	----------------	-------	------

### E Gel Vandal Mark Remover

- Removes marks created by crayon, pencil, inks, spray paints, tape, waxes and lipstick
- Formulated for use on brick, tile, steel, brass, chrome, aluminum, glass, Formica and other hard surfaces
- Gel formula clings to surfaces all for longer penetration time

880W	net wt. 15 oz	12/cs	18 lb
------	---------------	-------	-------



❖ Non-stocked item requires special order



## Metered Air Freshener Systems

### A Metered Aerosols

- Contains Ordenone™ Odour Neutralizer
- Does not mask odours - it eliminates them!
- Effective on smoke and other malodours
- Contains more than 3000 metered releases
- Dry formula; no messy fall out

SW104	7 oz	Dutch Apple	12/cs	7.5 lb
SW106	7 oz	Mulberry Breeze	12/cs	7.5 lb
SW107	7 oz	Wild Cherry	12/cs	7.5 lb
SW108	7 oz	Touch of Vanilla	12/cs	7.5 lb
SW109	7 oz	Cucumber Melon	12/cs	7.5 lb
SW110	7 oz	Fresh Linen	12/cs	7.5 lb
SW112	7 oz	Citrus Blast	12/cs	7.5 lb
SW116	7 oz	Marvelous Mango	12/cs	7.5 lb
SW118	7 oz	Country Garden	12/cs	7.5 lb



## Natural Oil Metered Aerosols

### B Fusion Metered Aerosols

- Made with natural oils and superior fragrances that don't have the harsh chemical overtone
- Contains Ordenone™, which encapsulates and eliminates odours
- Smaller particle size means the scents stay in the air longer
- Dry formula doesn't leave a build up on surfaces
- Deodorizes up to 6,000 cubic feet; 3200 sprays
- Environmentally safe; no ozone depleting ingredients
- Fits in CL7-MADISP Dispensers and competitors' cabinets

MA12CB	6 oz	Cotton Blossom	12/cs	8 lb
MA12CM	6 oz	Cucumber Melon	12/cs	8 lb
MA12SWP	6 oz	Sweat Pea	12/cs	8 lb
MA12HS	6 oz	Honeysuckle	12/cs	8 lb
MA12SA	6 oz	Spiced Apple	12/cs	8 lb
MA12STP	6 oz	Strawberry Pear	12/cs	8 lb
MA12WB	6 oz	Wildberry	12/cs	8 lb
MA12LF	6 oz	Linen Fresh	12/cs	8 lb
MA12MG	6 oz	Mango Breeze	12/cs	8 lb
MA12CN	6 oz	Cinnamon Stick	12/cs	8 lb
MA12CS	6 oz	Citrus Sorbet	12/cs	8 lb
MA12VB	6 oz	Vanilla Bean	12/cs	8 lb



### C Metered Aerosol Dispenser

- Uses two C batteries that last approximately 1 year (depending on settings); set for 7.5, 15 or 30 minutes
- Red light indicates can is empty
- Key lock mechanism
- Slim and compact

CL7-MADISPC	White	Sold ea	1 lb
-------------	-------	---------	------

### D Metered Aerosol Dispenser

- Uses two AA batteries that last 90 - 120 days (depending on settings); set for 7.5, 15 or 30 minutes
- Key lock mechanism
- Slim and compact

CL7-MADISP2	White	Sold ea	1 lb
-------------	-------	---------	------

NOTE: For replacement batteries, see page 14

## Total Release Odor Neutralizers

### A Blast Out Total Release Odor Neutralizer

- Dual action actuator can be locked in place for total release of product or pressed slightly to purge small amounts
- Contains Ordenone™ Odour Neutralizer
- Eliminates unpleasant odours in your car, boat, RV or other vehicles, hotels/motels, etc.
- Creates a deep-reaching fogging mist effective on odours caused by mustiness, pet urine, mildew, decay and tobacco smoke
- Long lasting fragrance to neutralize odours; does not just mask

SW245	❖	5 oz	Cherry	12/cs	10 lb
SW246	❖	5 oz	Vanilla	12/cs	10 lb
SW247		5 oz	Leather	12/cs	10 lb
SW248		5 oz	Fresh	12/cs	10 lb
SW249	❖	5 oz	Pina Colada	12/cs	10 lb
SW250		5 oz	Lemon	12/cs	10 lb
SW251		5 oz	Bubble Gum	12/cs	10 lb
SW252		5 oz	Mountain Air	12/cs	10 lb
SW253		5 oz	Cinnamon	12/cs	10 lb
SW254	❖	5 oz	Cream Soda	12/cs	10 lb



## Air Fresheners

### B Attack-Odour Counteractant & Air Freshener

- Chemically pure, scientifically formulated
- Tobacco smoke and other malodour neutralizer
- Fresh orange scent

70000		net wt. 13 oz		12/cs	16 lb
-------	--	---------------	--	-------	-------

### C Dry Air Fresheners with Ordenone™

- Attacks offensive odours and provides instant deodorizing
- Safe for use on most fabric, upholstery, carpet and drapes without staining or leaving residues
- Destroys odours such as tobacco, mildew and other malodours

161W		10 oz	Apple Blossom	12/cs	12 lb
162W		10 oz	Cinnamon	12/cs	12 lb
165W		10 oz	Tropical Fruit	12/cs	12 lb



### D Air Fresheners with Ordenone™

- Air Fresheners with Ordenone™ are an odour counteractant, NOT a masking product
- Ordenone™ encapsulates unpleasant odours and neutralizes them
- Leaves a pleasant, long-lasting fragrance
- Highly effective on smoke, pet, food and body odours, vomit, urine
- Use on carpeting, draperies, upholstery, clothing, bedding, fabric, automotive interiors, etc.
- Freshens new/used cars, RV's, in hotels/motels, bars/restaurants, hospitals and nursing homes, etc.
- Highly concentrated - a 5 second spray that is as effective as some odour bombs
- Dry spray produces a fine mist with low 'fall-out'
- Leaves vehicles with a pleasant, long lasting fragrance while ridding interiors of musty mildew and other undesirable odours

240W		15 oz	Mulberry Mist	12/cs	15 lb
244W		15 oz	Citrus Burst	12/cs	15 lb
575W		15 oz	Clean Breeze	12/cs	15 lb







## Exterior Auto Cleaners

### A Instant Detail Cleaner & Polish

- Quick detail touch-up; spray and wipe clean
- Rinse free
- Use between waxes to maintain that 'showroom quality shine'
- Gentle enough to use every day and safe for all paint types
- Removes harmful contaminants, fingerprints, water spots and surface dirt; repels water while adding protection to your finish

094	net wt. 16 oz	12/cs	16 lb
-----	---------------	-------	-------

### B Instant Detail Wax

- Wax in minutes; no buffing necessary
- No powder or dust residue
- Adds a 'showroom quality shine' with very little effort
- Wax your entire vehicle in minutes with protection, water-beading and shine that lasts for weeks
- Apply a light mist and wipe with a dry, clean towel or microfibre cloth

096	net wt. 16 oz	12/cs	16 lb
-----	---------------	-------	-------



### C Instant Shine

- A great final detail product with a silicone based coating designed to treat vinyl, fabric, leather and polycarbonate substrates
- Specially formulated for vinyl, body mouldings, engine compartments and other polycarbonate substrates, including hard to reach air conditioner ducts
- Spray on and buff or let dry to a like new shine

936	net wt. 11 oz	12/cs	12 lb
-----	---------------	-------	-------

### D Low Pro Tire Shine

- Ideal for use on low profile and all other tires
- High-gloss tire shine gives your tires a long-lasting wet look
- Helps restore body and moisture to dried-out tires and trim
- Custom spray pattern is perfect for narrow or low profile tires, allowing you to spray and go
- No wiping required

SW930	net wt. 14.5 oz	12/cs	15 lb
-------	-----------------	-------	-------



### E Brake Parts Cleaner

- Quickly removes grease, dirt, brake fluid and grime from critical brake components
- Flush away contaminants without disassembling the brake unit
- Non-chlorinated and Hexane-free
- High pressure spray evaporates fast
- Restores smooth brake operation
- Use on valve covers, clutch housings, clutch pressure plates and transmission

SW070	net wt. 14 oz	12/cs	14 lb
-------	---------------	-------	-------

### F Interior Detailer

- Quick drying, greaseless and streakless matte finish detail product
- Enhance and recondition the appearance of dash boards, vents, mouldings and consoles that aren't made of rubber or vinyl
- VOC compliant

780	net wt. 12 oz	12/cs	14 lb
-----	---------------	-------	-------

❖ Non-stocked item requires special order

## Interior Auto Cleaners

### A Fabric Cleaner Plus

- Effectively removes soils from most upholstered fabrics, including velour, cloth and carpeting
- The high foam does not soak into fabric, but leaves it clean and dry with a fresh wintergreen scent
- Helps leave car and truck interiors with a "like new" look and smell
- Use on RV carpets, office partitions, upholstered furniture and marine upholstery

508	net wt. 19 oz	12/cs	18 lb
-----	---------------	-------	-------

### B Fabric Cleaner

- Quickly and effectively removes soils from most upholstered fabrics
- Cleans without leaving the fabric wet
- The inverted valve allows for cleaning hard to reach areas
- Leaves the surface clean and dry with a fresh spearmint fragrance
- Use on most upholstered fabrics including velour, cloth and carpeting, RV carpets, office partitions, upholstered furniture and marine upholstery
- Use as a spotter or a cleaner for fast soil removal
- High foam quickly penetrates and emulsifies soils

558W	net wt. 19 oz	12/cs	18 lb
------	---------------	-------	-------

### C Leather Cleaner & Conditioner

- Cleans, conditions, renews and preserves leather surfaces
- Contains no silicones
- Provides a water repellent treatment to protect the fabric
- Adds moisture to leather surfaces, restoring suppleness
- Rich foam specially formulated with emollients, humectants, proteins, surfactants and conditioners to clean, condition and preserve strength and resiliency of new and old leather
- New leather fragrance

SW991	net wt. 14 oz	12/cs	14 lb
-------	---------------	-------	-------

## Stainless Steel Polish & Cleaner

### D Stainless Steel Polish & Cleaner

- Contains two special cleaning systems that remove all oil and water based dirt and grime from stainless steel
- No oily film, leaves a clear coating on stainless steel that actually repels dirt, grease and fingerprints

841W	net wt. 15 oz	12/cs	15 lb
------	---------------	-------	-------

### E Sheila Shine Stainless Steel Cleaner

- The world's finest steel polish and surface preservative
- Polishes and protects stainless steel, formica, porcelain and fine furniture

81000	10 oz/283.5 g	12/cs	10.5 lb
-------	---------------	-------	---------

### F Peek Mousse

- Unique formula cleans, polishes and protects fibreglass, ceramics and all metals
- Non-toxic, anti-oxidant; safe on skin
- Contains a protective ingredient against tarnishing

33800	150 g	12/cs	4.5 lb
-------	-------	-------	--------





## Insect Control

### A Crawling Insect Killer

- Up to 60-day residual effect
- 360° all angle spray
- Custom cap with holder for extension tube
- Crack and crevice treatment; kills when insects crawl on treated areas
- 0.25% Permethrin active
- Thorough applications produce a coating, which will vaporize into cracks and crevices for insect control
- Kills ants, cockroaches, earwigs, spiders, sow bugs, silverfish, fleas, brown dog ticks, house flies, aphids, bed bugs, etc.

<b>KD100P</b>	net wt. 439 g	12/cs	15 lb
---------------	---------------	-------	-------

### B Bedbug, Ant, Cockroach, Flea & Tick Killer

- Gives rapid contact kill
- Water-based; 360° all angle spray
- Breaks down in sunlight, not residual
- Pyrethrin 0.25% (Botanic); fast acting for an effective kill

<b>KD111P</b>	net wt. 400 g	12/cs	15 lb
---------------	---------------	-------	-------

### C Flying & Crawling Insect Killer

- Kills and repels: Stable flies, horse flies, deer flies, house flies, mosquitoes, wasps, moths and crawling insects such as cockroaches, spiders, crickets, ants, carpet beetles, centipedes, bed bugs, etc.
- Pyrethrin 0.5% (Botanic)
- Custom cap with holder for extension tube
- Use indoors or outdoors
- For Indoor use, spray away from walls, fabric and furniture and close room for 30 min; ventilate rooms for 30 min thereafter before re-entry

<b>KD120P</b>	net wt. 454 g	12/cs	16 lb
---------------	---------------	-------	-------

### D Total Release Fumigator

- Pyrethrin 0.4%
- Used manually or lock valve in open position for total release
- Ideal for rooms, attics, trailers, etc.
- No residual activity
- Kills spider mites, bed bugs, flies, mosquitoes, small flying moths, wasps, gnats, cockroaches, ants, fleas, ticks, spiders, silverfish, etc.

<b>KD400P</b>	net wt. 150 g	12/cs	7 lb
---------------	---------------	-------	------

### E Hornet & Wasp Killer - Foam Blaster

- Permethrin 0.20%
- For the control of wasps, bees, hornets and yellow jackets
- Not for use indoors, on humans or on animals
- Use to smother nests and block the exit of hornets and wasps
- Sprays as far as 3 metres or 10'

<b>KD130P</b>	net wt. 350 g	12/cs	13 lb
---------------	---------------	-------	-------

### F Hornet & Wasp Killer Blaster Spray

- For the control of wasps, bees, hornets and yellow jackets
- Tetramethrin 0.2%/D-phenothrin 0.125%
- Not for use indoors, on humans or on animals
- Dielectric 41kV; can be used to spray around wires, fuse boxes, lights
- Sprays as far as 6.1 metres or 20'

<b>KD131P</b>	net wt. 325 g	12/cs	12 lb
---------------	---------------	-------	-------

## Insect Control

### **A** Mosquito Shield Wilderness Formula

- Serious protection under heavy bug concentrations
- For the people that work outdoors
- Comes with a bonus compass (remove cap from can for compass to work due to the magnetic qualities of the can)
- Contains 30% DEET; strongest concentration available in Canada
- 360° all angle spray
- Contains aloe - easier on your skin

<b>MS0007</b>	net wt. 220 g	12/cs	8.5 lb
---------------	---------------	-------	--------

### **B** X-Max Flying Insect Killer

- Metered pressurized spray for the control of flies, gnats and mosquitoes
- Pyrethrin 1.8% with Synergist PBO 10.0%
- Use as a regular spray or in the KD201A BVT automatic aerosol dispenser
- Works with Konk dispensers
- One can protects a room up to 170 m<sup>3</sup> for up to 30 days
- Custom cap with holder for extension tube
- Use in attics, garages, outdoor storage buildings, horse stables, crawl spaces such as in basement areas. Do Not install in the living areas of the home such as kitchens, bedrooms or living rooms

<b>KD201D</b>	net wt. 212 g	12/cs	9 lb
---------------	---------------	-------	------

### **C** BVT Automatic Dispenser

- Use with KD201D; automatic with 9V battery (included)
- Releases a metered amount of insecticide at timed intervals 24 hours/day
- LED light changes from green to red when battery life is 10% or less
- Compatible with Konk #409 and #418

<b>KD201A</b>	White Dispenser	6/cs	5 lb
---------------	-----------------	------	------

### **D** Fruit Fly Trap

- Chemical free and easy to use in and around the home and breakrooms
- Bait with ripe fruit and watch as fruit flies are captured and unable to escape the patent pending design
- Funnel design allows flies in, but won't let them out
- Wash and re-use

<b>MS0502</b>	Fruit Fly Trap	6/cs	1.2 lb
---------------	----------------	------	--------

### **E** Spray Close Extender

- Attaches to your extension pole or broom handle
- Reach wasp or hornets nests safely without a ladder
- Use with paint cans to reach the tops of flag poles, etc. needing paint

<b>KD500S</b>	Spray Close Extender	6/cs	3.3 lb
---------------	----------------------	------	--------

❖ Non-stocked item requires special order





## Specialty Sprays & Adhesives

### A Fast Tack 87 General Purpose Adhesive

- Non-Staining formula; ideal for many lightweight-bonding applications
- High performance mist adhesive used for both temporary and permanent bonds
- Ideal for use in packaging, lightweight bonding and fabricating, labeling and shipping applications
- Use on many substrates, such as: wood to acrylics, paper/cardboard, fabric and felt; metal to acrylics, paper/cardboard, fabric and felt; rubber to acrylics, nylon, fabric and felt; paper to paper/cardboard, fabric and felt

087W	net wt. 13 oz	12/cs	13 lb
------	---------------	-------	-------

### B Anti-Static Spray

- Counteracts static electricity charges that attract dust, prevents materials from feeding properly or "shock" equipment operators
- Use on natural or synthetic rugs and carpeting, furniture, drapes, chairs, metal rollers, drive belts, scanners, and electronic image processors
- Helps prevent data loss and damage to a computer's memory
- Can also be used on metal rollers, drive belts; scanners, electronic image processors

955W	net wt. 14 oz	12/cs	14 lb
------	---------------	-------	-------



## Industrial Cleaners/Lubricants

### C Sprayway Black Label Industrial Products

- These premium industrial products will extend the life and increase the operating efficiency of your equipment
- Cleaners, degreasers, lubricants, moisture displacers and more
- **For product details, visit [www.spraywayblack.com](http://www.spraywayblack.com)**
- Net wt. 14 oz

SW285	D2 Solvent Degreaser	12/cs	14 lb
SW286	D3 Citrus Degreaser	12/cs	14 lb
SW287	C1 Penetrating Coil Cleaner	12/cs	14 lb
SW288	L1 Lubricant Protectant	12/cs	14 lb
SW289	L3 Moly PTFE Lubricant Protectant	12/cs	14 lb
SW290	L2 Moisture Displacer	12/cs	14 lb
SW291	M1 Moly Chain & Cable Lubricant	12/cs	14 lb
SW292	S1 Silicone Spray	12/cs	14 lb
SW293	P1 Precision Contact Cleaner	12/cs	14 lb
SW294	G1 Premium Gold Grease	12/cs	14 lb
SW295	T1 TFE Dry Coating Lubricant & Release Agent	12/cs	14 lb

❖ Non-stocked item requires special order



# Wipes & Wiping Cloths



## Disinfectant Wipes

### A Full Spectrum Disinfectant Wipes

- All purpose disinfecting cleaning wipe; premoistened with a bleach-free, alcohol-free and non-staining formula
- Suited for convenient anti-bacterial, all-purpose cleaning in grocery stores, restaurants, hospitals, nursing homes, kennels, health clubs and more
- Effective against: Human Immunodeficiency Virus Type 1 (HIV-1), Vancomycin Resistant Enterococcus (VRE), Escherichia coli, Feline Calcivirus, Mycobacterium Bovis BCG (Tuberculosis), Staphylococcus Aureus (VISA), Salmonella Choleraisuis, Staphylococcus Aureus, Pseudomonas Aeruginosa, Norovirus (Norwalk Virus)
- DIN #02314193
- Towel dimensions: 6" x 7"

1616	Tub of 180	6/cs	15 lb
------	------------	------	-------



### B Hand Sanitizing Wipes

- Prevents cross-contamination while they sanitize
- More convenient and easier to use than traditional hand washing with soap and water
- NPN Registered, #80025734
- Towel dimensions: 6" x 8"

1448	Tub of 70	6/cs	4.5 lb
------	-----------	------	--------

### C Alcohol-Free Hand Sanitizing Wipes

- Antibacterial yet gentle to skin
- Kill 99.99% of bacteria without the use of alcohol
- Sanitizes with BZK (Benzalkonium Chloride)
- Ideal for schools, hospitals, health clubs, municipal buildings and other areas where sanitizing is needed and alcohol is not desired
- Non-tacky formula moisturizes with Aloe and Vitamin E to leave hands feeling clean and fresh
- Convenient and easy to use
- Towel dimensions: 7" L x 8" W
- DIN #02399350

1445	Tub of 70	6/cs	7 lb
------	-----------	------	------



## Toilet Seat Wipes

### D Toilet Seat Wipes

- Cleans on contact and evaporates in seconds, leaving a clean, healthy toilet seat
- Biodegradable fabric; completely flushable
- Use on toilet seats, bathroom fixtures, door handles etc.
- Towel dimensions: 6" L x 6" W

1500TW	Tub of 160	6/cs	7 lb
--------	------------	------	------

### E Toilet Seat Wipe Dispenser

- Designed for use with #1500TW Toilet Seat Wipes
- Comes with wall mounting screws and tape

9218	Dispenser	1/cs	1 lb
------	-----------	------	------

## Hand Wipes

### A Scrubs in-a-Bucket® Hand Cleaner Towels

- Heavy-duty towel with pumice scrubbing power
- Premoistened with citrus based hand cleaner
- Cleans hands - no rinsing, drying or residue
- Towel dimensions: 12¼" L x 10½" W

<b>DC422</b>	Bucket of 72	6/cs	17 lb
--------------	--------------	------	-------

### B Multi-Purpose Hand Towels

- Designed for use in industrial and manufacturing settings
- Pre-moistened with a high-powered, multipurpose, grease-cutting formula that lifts away tar, adhesives, wax, ink, paint and lubricants from hands and other non-porous surfaces
- Enhanced with natural oils and emollients making them safe for hands and skin
- Perfect to use on: kitchen countertops, refrigerators, telephones, toilets, trash cans, etc.
- Uses include: industrial, plumbing, printing, manufacturing, construction, painting, transportation, maintenance, and marine equipment
- Towel dimensions: 9½" x 12"

<b>1539</b>	Tub of 70	6/cs	11 lb
-------------	-----------	------	-------

### C Battery Acid Cleaning Wipes

- Neutralizes battery acids without harming your hands
- Gentle but effective wipes clean corrosion and other contaminants from battery terminals
- Unique colour indicator formula will turn from blue to pink in presence of acid, then turn back to blue once the acid is neutralized
- Neutralizing fluid on the wipes does not cause foaming action and leaves a clean, protective barrier on the terminals and contact areas
- Use on several battery types: car, alkaline, rechargeable and lithium
- Towel dimensions: 7" L x 8" W

<b>1525BW</b>	Tub of 30	6/cs	7 lb
---------------	-----------	------	------

## Glass Cleaner Wipes

### D Crystal Glass Cleaning Wipes

- Clean glass and make it shine in seconds
- Powerful ammonia-free formula quickly removes dust, dirt, oil and grease smudges, water spots, fingerprints and smoke film from glass surfaces, leaving them with a sparkling shine
- No sticky film left behind
- Use on glass and tinted glass, windows, display cases, glass tables, windshields, mirrors, light fixtures, shower doors, etc.
- Lint-free towel
- Towel dimensions: 7" L x 8" W

<b>1558</b>	Tub of 70	6/cs	12 lb
-------------	-----------	------	-------

### E Clean Screens Wipes

- Moist towelettes clean without screen removal
- Also good for window blinds and ceiling fans
- Lint free technology
- Resealable pouch

<b>30155</b>	Screen Wipes, 25/pk	12/cs	6.5 lb
--------------	---------------------	-------	--------

❖ Non-stocked item requires special order







## Hard Surface Wipes

### A Quick Wipes All-Surface Cleaning Wipes

- Specially formulated to clean and deodorize
- Excellent for quick and convenient cleaning of shopping carts, equipment, and furniture in grocery stores, etc.
- Fits in either the 9123 or 9125 Dispensers
- Towel Dimensions 8" x 5"

<b>1574QW</b>	Bag of 1100	2/cs	13 lb
<b>9123</b>	Small Dispenser	1/cs	2 lb

### B Facility Wipes

- Fortified with a mild combination of quaternary cleaners that allow you to clean and deodorize your entire facility
- Designed for use with a center-pull dispenser
- Towel dimensions: 8" x 10"

<b>1574</b>	Bag of 800	2/cs	20 lb
<b>9125</b>	Dispenser	1/cs	3 lb

### C Dispenser Stand

- Equipped with signage placards or letter-size, eye-catching instruction information to meet your customer's need
- Centre-pull dispenser can be mounted upright or inverted to dispense wipes by pulling down or up
- Easy to assemble; all hardware included
- Ships economically in a single convenient, slim carton
- Accepts either the 9123 or 9125 Dispensers
- Stand dimensions: 63½" L x 18¼" W x 18¼" D

<b>9128</b>	Stand Only	1/cs	1 lb
-------------	------------	------	------

### D Wipes Dispenser Stand with Sign Holder

- Attractive black metal stand, for use with 120 mm canisters
- Includes slot for a sign and hooks for waste bag
- Large foot provides sturdy dispensing

<b>9127</b>	Dispenser Stand Only	1/cs	6 lb
-------------	----------------------	------	------

### E Cart Handle Wipes

- Specially formulated to clean and deodorize any surface, anywhere
- Excellent for quick and convenient cleaning of shopping carts, equipment and furniture in grocery stores and other facilities
- Cleans and deodorizes surfaces on contact
- Mount in a dispenser for convenient on-site use
- Towel Dimensions: 6" L x 6" W

<b>1574CH</b>	Tub of 450	6/cs	16 lb
---------------	------------	------	-------

### F Stainless Steel Dispenser Stand

- Attractive stainless steel design with integrated waste receptacle
- Provides immediate access to wipes
- Ideal for use with the 1574 Facility Wipes
- Use in fitness clubs, grocery stores, schools, etc.

<b>9135</b>	Stainless Steel	1/cs	16.3 lb
-------------	-----------------	------	---------

### G Large Wire Wipes Canister Holder

- White epoxy coated, wall-mount wire holder
- Holds 1539 Multi-Purpose Hand Towels, 1616 Full Spectrum Disinfectant Wipes, etc.

<b>9111</b>	White, Large	1/cs	1 lb
-------------	--------------	------	------

### H Small Wire Wipes Canister Holder

- White epoxy coated, wall-mount wire holder
- Holds 1448 and 1445 Hand Sanitizing Wipes or similar size tubs

<b>9112</b>	White, Small	1/cs	1 lb
-------------	--------------	------	------

## Graffiti Wipes

### A Scrubs® Graffiti & Spray Paint Remover Towels

- A high-quality graffiti remover formula in an absorbent, abrasive, non-scratching towel
- One-Step process; convenient and economical
- The formulation loosens, breaks down and dissolves paint and graffiti
- Works on hard non-porous surfaces such as metal, glass, plastic, vinyl and porcelain
- Towel dimensions: 12¼" L x 10½" W

90130	Container of 30	6/cs	8.5 lb
-------	-----------------	------	--------



### B Graffiti Wipes

- Pre-moistened with a powerful cleaning formula that does not contain amyl acetate or methylene chloride, making them safer to use than traditional graffiti removal products
- Used for fast, easy clean-up of paint from non-porous surfaces
- Use them on various surfaces including: Bathroom partitions, aluminum siding, desks, phone booths, road signs, wall tile, stainless steel, etc.
- Non-toxic when compared with other paint and graffiti removers
- Environmentally safe and biodegradable formula
- Towels stay moist for greater usage and longer shelf life
- Towel dimensions: 9½" x 12"

1447	Tub of 40	6/cs	8.5 lb
------	-----------	------	--------



## Metal Cleaning Wipes

### C Stainless Steel Cleaner Wipes

- Clean, polish and protect stainless steel surfaces in one easy step
- Each wipe is pre-moistened with a citrus-based formula that removes grease, grime, smudges, fingerprints and watermarks
- Leaves behind a clear, protective coating which shines surfaces and preserves them from unsightly water marks and harmful corrosion
- Perfect to use on any Stainless Steel surface including diner grills, elevator surfaces, beverage dispensers, etc.
- No harsh chemicals; leaves a pleasant citrus fragrance
- Also works on brass, silver, chrome and copper
- Towel dimensions: 9½" x 12"

1549	Tub of 40	6/cs	7 lb
------	-----------	------	------

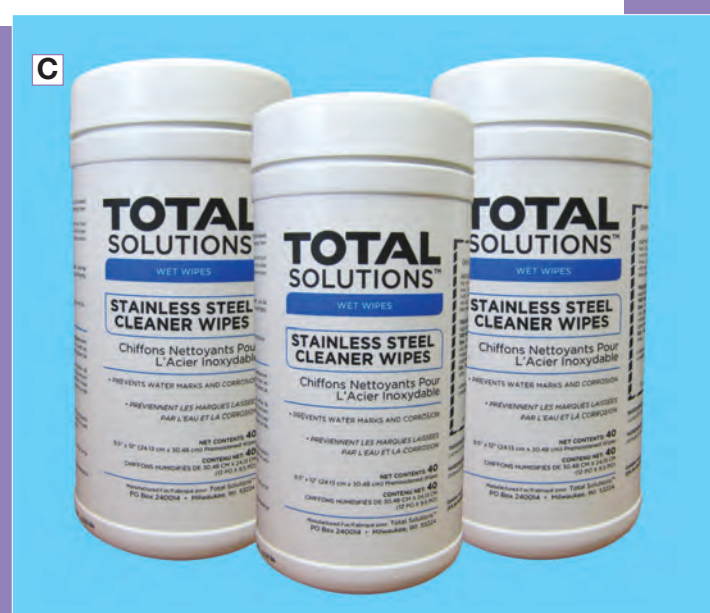

❖ Non-stocked item requires special order



## Disposable Wipes

### A Food Service Wipe - Blue

- Wipe tables, seats, trays, counters
- Use for general cleaning
- Rinses clean, dries fast, stays fresh
- Reusable and disposable
- Towel Dimensions: 11¾" L x 24" W

<b>8279A</b>	Blue	100/cs	3 lb
--------------	------	--------	------



### B Economy Wipe

- Wipe tables, seats, trays, counters
- Use for light housekeeping
- Rinses clean, dries fast, stays fresh
- More economical than linen
- Reusable and disposable
- Towel Dimensions: 13" L x 24" W

<b>8270G</b>	Green/White	150/cs	2.6 lb
--------------	-------------	--------	--------



### C QuatGuard® XL Microfibre Wipe

- 100% quat and chlorine compatible
- Removes 99.9% of bacteria
- Absorbent
- Durable and reusable
- Engineered to provide enhanced microfibre cleaning capabilities
- Cross functional applications throughout food service facilities
- Use in restaurants, bars, homes, restrooms, etc.
- Towel Dimensions: 13½" L x 21" W

<b>9525</b>	White	96/cs	4.5 lb
-------------	-------	-------	--------



### D Treated Dust Cloth

- Use for building maintenance/contract cleaning or in institutions such as hospitals, long term care facilities and schools
- Use for floors or hand dusting
- For general dusting, including office and computer equipment
- Light oil treatment removes dust without using dusting agents
- Convenient size for floor and hand dusting
- Unique dust cloth fabric stretches to capture and retain dust particles
- Fits MT4071 Standard Tool Set
- Towel Dimensions: 24" L x 24" W

<b>2925</b>	Yellow	200/cs	7 lb
-------------	--------	--------	------

### E Dust Magnet/Moplux Standard Tool Set

- The best solution for clean-ups where strict attention to health standards is necessary
- Includes 23" Standard Holder (0584237000) and Adjustable Handle (0584357000)

<b>MT4071</b>	Complete	1/cs	2 lb
---------------	----------	------	------

❖ Non-stocked item requires special order

## Microfibre Cloths

- With millions of tiny, super absorbent strands, these cloths can actually reach down inside the smallest indentations of any surface
- New patented hemming finish keeps the cloth in its original shape with no migration of lint or threads
- 80% Polyester, 20% Polyamide material
- Machine washable and can be dried in a standard dryer at a low temperature (**Caution:** Do not use bleach or fabric softener)



**Conventional**                      **Microfibre**

### A Microfibre—SuperPro

- Knitted with patented hemming
- 300 gsm face weight
- Machine washable up to 1000 times

<b>A30102</b>	Blue	16" x 16"	10/pk	200/cs	24 lb
<b>A30103</b>	Red	16" x 16"	10/pk	200/cs	24 lb
<b>A30105</b>	Yellow	16" x 16"	10/pk	200/cs	24 lb
<b>A30106</b>	Green	16" x 16"	10/pk	200/cs	24 lb
<b>A50102</b>	Blue	14" x 14"	10/pk	200/cs	24 lb
<b>A50103</b>	Red	14" x 14"	10/pk	200/cs	24 lb
<b>A50105</b>	Yellow	14" x 14"	10/pk	200/cs	24 lb
<b>A50106</b>	Green	14" x 14"	10/pk	200/cs	24 lb

### B Microfibre Mitt without Thumb

- A great choice for dusting and cleaning
- Safe for dusting and cleaning without chemicals or oils
- Microfibre dusters have the same great qualities as cloths but can be used in harder to reach areas like ceiling fans, shelves and irregular surfaces
- Can be laundered

<b>LFRMIT</b>	Blue	180/cs	24 lb
---------------	------	--------	-------

## Microfibre Bar Wipes

- Overlock stitched hem prevents fraying, improving the life of the cloths
- Lint free; more absorbent than terry towel cloths
- Cloths can be laundered as much as 500 times

### C MaintenancePro White Microfibre Bar Wipe

- Ribbing on both sides improves scrubbing and drying action
- Standard hospitality blue stripe on both sides

<b>A40100</b>	14" x 18"	10/pk	200/cs	24 lb
---------------	-----------	-------	--------	-------

### D MaintenancePro White Microfibre Bar Wipe

- Ribbing on one side; scrub with one side and neatly wipe away any mess; standard hospitality blue stripe on one side only
- Regular microfibre on the other side for cleaning dishes or use as a damp/dry dusting and polishing cloth

<b>A40101</b>	14" x 18"	10/pk	200/cs	24 lb
---------------	-----------	-------	--------	-------

**A**



**B**



**C**



**D**

**NEW!**

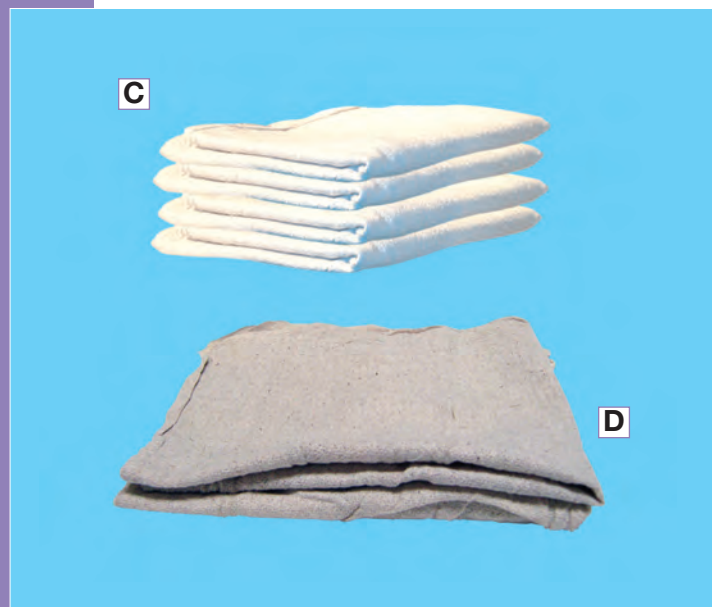

## Enduro Cloth

### A Enduro Cloth™

- Reusable; lint free
- Resistant to tearing and abrasions
- Closed pores won't harbor bacteria
- Highly absorbent; holds up to 20 times its own weight in water
- Made of natural materials (approx. 70% cellulose, 30% cotton)
- 100% biodegradable
- Reduces waste by replacing sponges, cotton towels, wipes and up to 15 rolls of paper towels over the life of one cloth
- Machine washable & dishwasher safe
- Lasts for up to 300 washes
- Eliminates water droplet trails other towels leave behind

<b>10100</b>	Red, SM	9¾" L x 8" W	5/pk	0.2 lb
<b>10200</b>	Blue, SM	9¾" L x 8" W	5/pk	0.2 lb
<b>10300</b>	Yellow, SM	9¾" L x 8" W	5/pk	0.2 lb
<b>10400</b>	Green, SM	9¾" L x 8" W	5/pk	0.2 lb
<b>20100</b>	Red, L	12" L x 10½" W	5/pk	0.3 lb
<b>20200</b>	Blue, L	12" L x 10½" W	5/pk	0.3 lb
<b>20300</b>	Yellow, L	12" L x 10½" W	5/pk	0.3 lb
<b>20400</b>	Green, L	12" L x 10½" W	5/pk	0.3 lb

## Terry Towels

### B Terry Towel

- 100% new, all-cotton terry
- No polyester to scratch delicate surfaces
- Made of the best quality raw materials
- Economical and cost effective; 50 packs/bale
- Reusable and can be laundered many times
- Highly absorbent; strong and durable

#### White All Purpose—Plain

<b>PT21</b>	15" x 18"	12/pk	21 oz
<b>PT26</b>	16" x 19"	12/pk	26 oz

#### White All Purpose—B Quality

- 100% new, all-cotton terry
- No polyester to scratch delicate surfaces
- Assorted sizes: 16" x 19" & 15" x 18"
- Not laundered
- Highly absorbent; strong and durable

<b>PT10</b>	65 towels/cs. (Approx.)	10 lb
<b>PT25</b>	160 towels/cs. (Approx.)	25 lb
<b>PT100</b>	642 towels/bale (Approx.)	100 lb

### C White Foodservice Towel - Premium

- 100% new, all-cotton terry
- No polyester to scratch delicate surfaces
- Ribbed weave, bordered hem
- Highly absorbent, strong and durable
- 50 packs/bale

<b>PT28</b>	16" x 19"	12/pk	28 oz
-------------	-----------	-------	-------

## Shop Towels

### D Shop Towel

- 100% new, all-cotton

<b>PT12BE</b>	Beige	12" x 13¾"	50/pk	12 oz
---------------	-------	------------	-------	-------

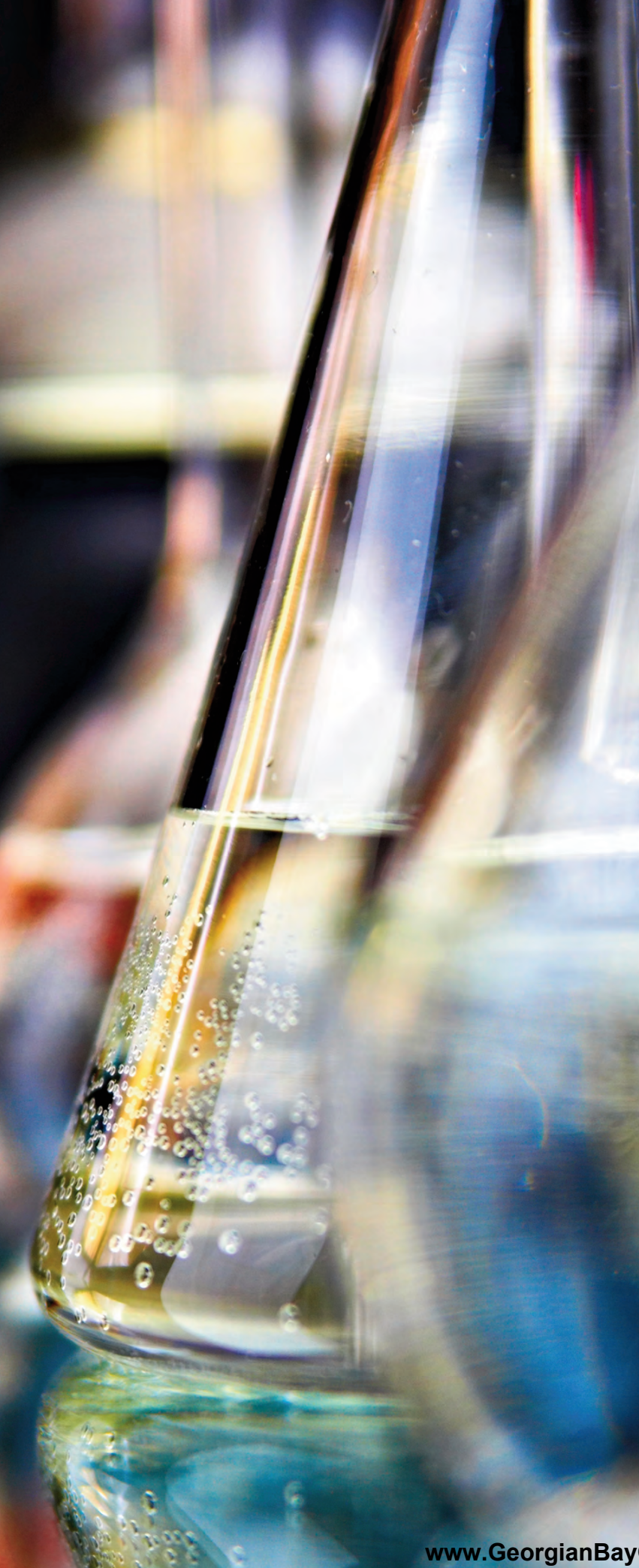

# Cleaning Chemicals & Odour Control



## Disinfectants

### A Terminator 2 Disinfectant

- Ready to Use, DIN registered hard surface disinfectant/sanitizer
- Virucide, Bactericide, Fungicide, Mildewstat, Parvovirus, VRE, MRSA, VRSA, HIV-1
- Specially formulated for use in medical and non-medical institutions. Safe for use on any washable surface.
- Eliminates foul odours
- Also available in economical 4 litre refills **17333**

<b>17330</b>	946 mL	6/cs	12 lb
<b>17333</b>	4 L	4/cs	32 lb

### B Enviro Care® Neutral Disinfectant

- Concentrated, quaternary-based germicidal detergent and deodorizer; phosphate free
- Neutral pH; hard water/organic soil tolerant
- Effective against HIV-1, CA-MRSA, Influenza A, VRE and other gram-negative and gram-positive pathogens
- Recommended for use in hospitals, nursing homes, schools, commercial and industrial institutions, veterinary clinics, etc.
- Dilutes with simple tap water
- Floral/citrus fragrance
- DIN registered #02130661

<b>11258136</b>	1 US gal/3.78 L	4/cs	36 lb
<b>11258114</b>	32 oz/946 mL EnviroMix Container	6/cs	14 lb



### C Enviro Care® Neutral Disinfectant - No Fragrance

- Same benefits as Enviro Care® Neutral Disinfectant (B) without fragrance

<b>12001236</b>	1 US gal/3.78 L	4/cs	36 lb
-----------------	-----------------	------	-------

### D Disinfectant Spray for Health Care

- Phenolic disinfectant and deodorant spray; an odour counteractant that chemically neutralizes malodours
- Kills most germs, including HIV-1 (AIDS Virus), Herpes Virus I and II, and Tubercule Bacilli (TB)
- Fungicidal (controls mould and mildew), bactericidal, staphylocidal, tuberculocidal, virucidal and pseudomonocidal to help stop the spread of diseases
- DIN #02246035

<b>015DIN</b>	net wt. 15.5 oz	12/cs	12 lb
---------------	-----------------	-------	-------

### E Disinfectant Surface Cleaner

- Disinfects Influenza A2/Japan Virus and Herpes Simplex Virus Types 1 and 2 on hard, non-porous environmental surfaces
- Kills Pandemic 2009 H1N1 Influenza A Virus ("swine flu")
- Antibacterial, Bactericidal, Virucidal and Fungicidal
- Cleans and deodorizes; spray and wipe shining clean
- For use in homes, hospitals, nursing homes, medical facilities, businesses, hotels, motels, restaurants, schools, institutions and commercial establishments
- DIN #02246034

<b>866DIN</b>	net wt. 19 oz	12/cs	18 lb
---------------	---------------	-------	-------

◆ Non-stocked item requires special order



## All Purpose/Hard Surface Cleaners

### A Combat Heavy Duty Citrus Cleaner

- Made from naturally derived citrus oil; contains no petroleum solvents
- Cuts through heavy grease accumulation with ease
- Dissolves rubber tire marks on concrete
- Biodegradable; safe for use on all hard surfaces

11233639	1 US gal/3.78 L	4/cs	39 lb
----------	-----------------	------	-------

### B Perfect 7

- All purpose cleaner formulated to clean walls, floors, chrome, porcelain and stainless steel
- Includes mild grease-cutting properties
- Will rapidly penetrate and emulsify a wide variety of soils

11237339	1 US gal/3.78 L	4/cs	38 lb
----------	-----------------	------	-------

### C DfE 401 Heavy Duty Neutral Cleaner

- Formulated to be safer for the product user, building occupants and the environment compared to traditional cleaning products
- Can be applied with a mop, brush or through an automatic scrubber
- Cleans the widest range of soils when matched to the correct dilution
- Excels in cleaning hard surfaces like concrete and stone floor with an automatic scrubber
- Neutral pH; highly dilutable
- Low sudsing and rinses easily
- Certified Kosher

11792839	1 US gal/3.78 L	4/cs	36 lb
----------	-----------------	------	-------

### D Enviro Care® Tough Job Cleaner

- Non-toxic, biodegradable, heavy-duty cleaner/degreaser
- Use as a carpet and upholstery pre-spotter and stain remover or spray-on, wipe-off cleaning, damp mopping, in automatic scrubbers, in pressure washers and steamers
- Perfect for fire and smoke damage clean up
- Concentrated; fragrance-free
- Use in cold tank soaking applications
- Will not harm or discolour aluminum or other soft metals

12001814	32 oz/946 mL Enviro Container	6/cs	14 lb
----------	-------------------------------	------	-------

12001836	1 US gal/3.78 L	4/cs	36 lb
----------	-----------------	------	-------

### E Orange Citrus Crazy Clean All Purpose Cleaner

- Formulated with a natural orange citrus solvent and emulsifiers that provide remarkable cleaning power on the heaviest of soils, greases, and oils
- Cleans and deodorizes surfaces on contact, safe to use where soap or detergents would be acceptable

985W	net wt. 19 oz	12/cs	18 lb
------	---------------	-------	-------

### F Solopine Deodorant Cleaner

- Contains natural pine oil, emulsifiers and surfactants
- Ideal for floors and walls of public buildings, schools, factories, railroad and bus terminals or anywhere an excellent clean and a pleasant pine aroma is desired
- Works well in hard or soft water and controls hard water minerals
- Use on any washable surface
- Highly concentrated and economical

10539039	1 US gal/3.78 L	4/cs	37 lb
----------	-----------------	------	-------







## All Purpose/Hard Surface Cleaners

### A OdoBan Odor Eliminator

- Multi-purpose cleaner and air freshener
- Concentrate - makes 32 gallons
- Pleasant eucalyptus scent
- Removes odours caused by urine, mildew, smoke, pets, sewage backup and decaying organic matter
- Excellent for fire restoration

11002-G4	1 US gal/3.78L Jug	4/cs	36 lb
----------	--------------------	------	-------

### B The Original Kitchen Klenzer

- Powdered cleanser in a shaker-can delivers chlorine bleach and a fresh lemon scent
- Bleaches through food and beverage stains
- Safe for use on pots, pans, stoves and ceramic cookware
- Mildly aggressive scouring action effectively cleans and bleaches showers, tubs, sinks and toilet bowls
- Cuts and removes grease on garage floors, removes soils on barbecue grills, garbage cans, auto chrome, whitewall tires and many other difficult to clean surfaces

39024	14 oz/400 g	24/cs	22 lb
-------	-------------	-------	-------



## Laundry Detergent

### C Power Klean Laundry Detergent

- Low suds, concentrated detergent
- Low cost per load, washes up to 150 loads
- Biodegradable & phosphate free; safe for all fabrics
- Works great on wash 'n wear and fine fabrics
- Made in Canada (Includes free scoop)
- Cannot be used in High Efficiency machines

17481	13.6 kg Pail	Sold ea	30 lb
-------	--------------	---------	-------

## Drain Openers/Bathroom Cleaners

### D Open Sesame Drain Flush

- Highly active acid based drain opener
- Works fast on organic waste, cloth and soap
- Inhibited to prevent corrosion

100101	32 oz/946 mL	12/cs	43 lb
--------	--------------	-------	-------

### E Wonder Creme™ Bowl Cleaner

- Germicidal creme bowl cleaner; clings to vertical surfaces
- Deodorizes, disinfects and cleans toilets and urinals

100401	31 oz/909 mL	12/cs	35 lb
--------	--------------	-------	-------

### F Enviro Care® Washroom Fixture Cleaner

- For keeping basins, showers, bowls, urinals and washroom surfaces clean and fresh in one easy step
- The mild food-grade acidic formula removes soap film, body oils, make-up and mineral deposits from any washable surface without damage
- Removes difficult stains from ceramic tile floors and grout
- This one-step cleaner cuts through grime and requires no rinsing
- Phosphate free and biodegradable
- Pleasant Floral Fragrance

12002014	32 oz/946 mL Enviro Container	6/cs	14 lb
----------	-------------------------------	------	-------

12002036	1 US gal/3.78 L	4/cs	39 lb
----------	-----------------	------	-------

◆ Non-stocked item requires special order



## Glass Cleaner

### A See Thru Glass Cleaner

- Cleans glass, mirrors and other glazed or polished surfaces
- May be used as an all-purpose spray and wipe cleaner
- Non-streaking, non-ammoniated and non-flammable
- Ready-to-use formula
- Use outside or inside in hot or cold weather; dries fast

11003139	1 US gal/3.78 L	4/cs	36 lb
----------	-----------------	------	-------

### B Enviro Care® Glass Cleaner

- Non-streaking cleaner for glass, mirrors, stainless steel, formica, ceramic tile, plastic and other polished surfaces
- Alcohol-free, solvent-free, non-ammoniated, non-flammable, non-toxic and biodegradable
- Use on glass, mirrors, porcelain, enamel, stainless steel, chrome, formica, plastic, ceramic tile and other polished surfaces

12001014	32 oz/946 mL Enviro Container	6/cs	14 lb
12001036	1 US gal/3.78 L	4/cs	37 lb

### C Glass Cleaner

- The most versatile glass cleaner available - cleans glass, windows, mirrors, windshields, enamel surfaces, chrome, tile, porcelain and other hard surfaces
- Dissolves dirt, grease, grit and grime
- Heavy-duty foam clings to vertical surfaces
- Guaranteed to leave no film
- Contains perfume-grade alcohol for best performance

SW050CC	net wt. 19 oz	12/cs	18 lb
---------	---------------	-------	-------

## Hard Surface Polishers & Cleaners

### D Stainless Steel Polish & Cleaner

- Contains two special cleaning systems that remove all oil and water based dirt and grime from stainless steel
- No oily film, leaves a clear coating on stainless steel that actually repels dirt, grease and fingerprints

841W	net wt. 15 oz	12/cs	15 lb
------	---------------	-------	-------

### E Sheila Shine Stainless Steel Cleaner

- The world's finest steel polish and surface preservative
- Polishes and protects stainless steel, formica, porcelain and fine furniture

81000	10 oz/283.5 g Aerosol	12/cs	10.5 lb
81001	1 Quart/946 mL	12/cs	24 lb
81002	1 US gal/3.78 Litres	4/cs	31.5 lb

### F Peek Multi Purpose Metal Polish

- Unique formula cleans, polishes and protects fibreglass, ceramics and all metals including brass, bronze, copper, gold, pewter, platinum, silver and stainless steel
- Non-toxic, anti-oxidant; safe on skin
- Contains a protective ingredient against tarnishing
- Excellent results even under harsh conditions
- NSF registered

33500	3.93 oz/100 mL Tube	24/cs	8 lb
33400	8.5 oz/250 mL Liquid	10/cs	9 lb
33800	5.25 oz/150 g Mousse	12/cs	7 lb
33300	34 oz/1000 mL Can	6/cs	14 lb





## Enzymatic Control Systems

### A BioOdor Control Odor Digester Bacterial Enzyme Odor Control System

- Non-pathogenic active bacterial cultures and enzymes that biologically digest carbohydrates, proteins and lipid residue (the oily film that develops on surfaces and traps soilage)
- The live action formula effectively cleans while it completely consumes and digests organic materials and malodours
- Effective for malodours caused by dampness, mildew, vomit, fecal and organic matter, urine, spoiled food and garbage
- Non-staining on carpets, upholstery and water-safe surfaces
- Biodegradable, non-pathogenic to animals and humans; certified salmonella-free

270-Q	32 oz/946 mL Bottle	12/cs	27 lb
270-4	1 US gal/3.78L Jug	4/cs	36 lb
270-5	5 US gal/19 L Pail	Sold ea	45 lb

### B BioOdor Mist Stik Auto Spray Dispenser

- Delivers a droplet spray dosage in a wide area pattern
- Programmable timer enclosed with 12 V DC transformer
- Mounts easily into a 5 U.S. gallon pail (sold separately)

DISS		Sold ea	4 lb
------	--	---------	------

**NOTE:** Mist Stik Auto Spray Dispenser shown with 5 U.S. gallon pail, not included

### C BioDrain Control Grease & Waste Digester Bacterial Enzyme Grease Trap Treatment System

- Unclogs drain lines and grease traps
- No caustics, acids or solvents (natural non-pathogenic active bacteria), non-toxic
- Digests the cause of odours (grease, fat, paper, proteins, carbohydrates and soap scum)
- Digests a broad spectrum of organic waste throughout the entire drain system to greatly reduce build-up in the grease trap, resulting in lower maintenance costs
- Reduces disposal cost (pumping, landfill fees, service calls, wastewater treatment fines)
- Highly resistant to free chlorine disinfectants and sanitizers
- Resists hot water to 200° F

280-Q	32 oz/946 mL Bottle	12/cs	27 lb
280-4	1 US gal/3.78L Jug	4/cs	36 lb
280-5	5 US gal/19 L Pail	Sold ea	45 lb

### D BioDrain Pail Stik Auto Dispenser

- Programmable timer enclosed with 12 v DC transformer
- Mounts easily into a 5 U.S. gallon pail (sold separately)

DIS5		Sold ea	4 lb
------	--	---------	------

**NOTE:** Pail Stik Auto Dispenser shown with 5 U.S. gallon pail, not included

◆ Non-stocked item requires special order

## Enzymatic Control Systems

### A Enviro Care® Liqui Bac

- Digests organic waste in grease traps, portable toilets and septic tanks
- A living, non-pathogenic bacterial treatment that breaks down and liquefies solids such as fats, proteins, carbohydrates and grease
- Formulated with non-pathogenic bacteria for general odour control and carpet deodorizing
- Biodegradable; non-corrosive and contains no hazardous ingredients

11819989	32 oz/946 mL	12/cs	28 lb
11819914	32 oz/946 mL Enviromix Container	6/cs	28 lb
11819936	1 US gal/3.78 L	4/cs	36 lb



## Carpet Care

### B PROXI™ Spray and Walk Away

- Spray and Walk Away
- Cleans and dries quickly; no rubbing, scrubbing, blotting, rinsing
- Oxidizes stain molecule and eliminates odours
- Non-bleaching, no VOCs, no residue
- Patent-protected technology
- Hydrogen Peroxide is a well-known antiseptic and disinfectant
- PROXI leaves a clean smell because of the oxidation of odour causing microbes

673	946 mL	12/cs	27 lb
634	3.78 Litres	4/cs	36 lb



### C Carpet Control 3-in-1 Carpet Cleaner

- Concentrated carpet cleaner designed to be 3 products in 1: traffic/lane prespray, spot cleaner and extraction cleaner
- Safely cleans carpets without the use of detergents or harmful chemicals, eliminating the need for a defoamer or additional rinsing agents
- Patent-pending detergent free formulation suspends dirt and soil, reducing wear and damage to carpet fibres

602-4	1 US gal/3.78L Jug	4/cs	36 lb
-------	--------------------	------	-------

### D Enviro Care® Carpet & Upholstery Cleaner

- A versatile, highly concentrated solution that cleans, brightens and deodorizes colourfast carpet, upholstery or other fabric
- Perfect for extraction as well as spin bonnet cleaning
- Uses liquid live microorganisms to digest odour-causing substances
- Continues to actively deodorize long after the cleaning process has been completed
- Phosphate free
- Biodegradable
- Non-Corrosive; no hazardous ingredients

11257840	2.5 US Gal/9.5 L	2/cs	46 lb
----------	------------------	------	-------

❖ Non-stocked item requires special order





## Mötsenböcker's Lift Off®

- No hot solvents, no harsh odours, safe for all surfaces
- Patented products for the professional
- Used by Coca Cola®, MGM Grand Las Vegas, McDonalds®, Marriot Hotels®, Disney Theme Parks®, Delta Airlines, BlockBuster Video®, Transit Authorities and many more

### A #1 Food, Beverage & Protein Stain Remover

- Biodegradable and water-based
- Designed specifically to remove stains such as coffee, tea, Kool-Aid® soda pop, sauces, ketchup, blood and grass, in addition to other water or protein-based spots and stains

40501	Spray Bottle	22 oz/651 mL	6/cs	10 lb
40503	◆ Bottle	946 mL/32 oz	6/cs	13 lb
40601	◆ Container	1 US gal/3.78 L	4/cs	36 lb

### B #2 Adhesive, Grease & Oily Stain Tape Remover

- Original petroleum-based formula, commercially and industrially proven
- Effectively removes chewing gum, adhesives, grease, tar, motor oil, sap and naturally oil-based foods such as salad dressings

40701	Spray Bottle	22 oz/651 mL	6/cs	10 lb
40703	◆ Bottle	946 mL/32 oz	6/cs	13 lb
40801	◆ Container	1 US gal/3.78 L	4/cs	36 lb

### C #3 Pen, Ink & Marker Graffiti Remover

- Biodegradable and water-based
- Designed to remove most types of ink including indelible ink, ball-point pen ink, permanent marker, highlighter and other related inks such as stamp pad ink
- Also removes nail polish and correction fluid
- Removes permanent markers from dry-erase boards
- Works on carpets, fabrics, furniture, walls and laundry

40901	Spray Bottle	22 oz/651 mL	6/cs	10 lb
40903	◆ Bottle	946 mL/32 oz	6/cs	13 lb
41001	◆ Container	1 US gal/3.78 L	4/cs	36 lb

### D #4 Spray Paint Graffiti Remover

- Biodegradable and water-based
- Works more effectively in the same time or better, and costs less per ounce than most solvents
- Patented formula actually breaks the molecular bond between the paint and the surface, unlike solvents or d-limonene-based removers that simply dissolve paint and spread it around
- Works on all surfaces including concrete, brick, stucco and street signs

41101	Spray Bottle	22 oz/651 mL	6/cs	10 lb
41103	◆ Bottle	946 mL/32 oz	6/cs	13 lb
41201	◆ Container	1 US gal/3.78 L	4/cs	36 lb



For more information, please visit the Motenböcker Lift Off website at [www.liftoffinc.com](http://www.liftoffinc.com)

◆ Non-stocked item requires special order

## Mötsenböcker's Lift Off®

- No hot solvents, no harsh odours, safe for all surfaces
- Patented products for the professional
- Used by Coca Cola®, MGM Grand Las Vegas, McDonalds®, Marriot Hotels®, Disney Theme Parks®, Delta Airlines, BlockBuster Video®, Transit Authorities and many more

### A #5 Latex Based Paint Remover

- Biodegradable and water-based
- Breakthrough formula removes fresh latex paint and overspray, as well as dried old paint
- The only known water-based product that quickly and effectively removes all types of latex-based paint from hard surfaces and brushes
- Because this is not a solvent, it is safe, economical and easy to use
- Works on carpets, concrete, furniture, cars and laundry

41301	Spray Bottle	22 oz/651 mL	6/cs	10 lb
41401	Container	1 US gal/3.78 L	4/cs	36 lb



## Graffiti Removal & Barrier

### B DfE-VMR Vandal Mark Remover

- A heavy-duty biologically-based product for managing tough jobs with minimal environmental impact
- Easily removes adhesives, inks, marker, paint and make-up
- Safe for use on metal; will not harm most surfaces
- Utilizes plant-based raw material
- Eucalyptus fragrance
- Lower VOC's
- Better indoor air quality; don't have to use "after hours"

11256598	32 oz/946 mL	6/cs	14 lb
----------	--------------	------	-------

### C Gel Vandal Mark Remover

- Removes marks created by crayon, pencil, inks, spray paints, tape, waxes and lipstick
- Formulated for use on brick, tile, steel, brass, chrome, aluminum, glass, Formica and other hard surfaces
- Gel formula clings to surfaces all for longer penetration time

880W	net wt. 15 oz	12/cs	18 lb
------	---------------	-------	-------

### D Graffiti Barrier

- Clear, odourless liquid can be applied to nearly any non-porous surface to provide a protective barrier against graffiti
- After application, it dries to a clear film to protect against spray paint, marker, pen and other substances
- Once a treated object is defaced, the barrier is easily removed with no damage to the surface
- Thickened formula adheres to vertical surfaces and is water-resistant, allowing for some outdoor applications
- Will not affect signs' reflective properties and will not yellow
- Use on lockers, doors, powder coated surfaces, walls, signs, windows, mirrors etc.
- Not for use on wood, painted and other porous surfaces
- Protects against spray paint, marker and pen
- Rinsable for easy removal and reapplication

333	1 US gal/3.78 L	4/cs	40 lb
-----	-----------------	------	-------



❖ Non-stocked item requires special order

## Odour Control

**A**



**B**



### **A Citro Fresh Dumpster Odor Eliminator**

- Contains natural citronella oil that repels insects
- Patented odour neutralizer combined with citronella oil eliminates odours at the source, leaving a pleasant citrus fragrance
- All natural granules infused with citronella oil absorbs liquids in waste receptacles

<b>24812</b>	12 oz/340 g	12/cs	12 lb
<b>2485</b>	5 US gal/19 L	1 Pail	21 lb
<b>24855</b> ♦	55 US gal Drum	208 L	155 lb

### **B Odor-Out Rug & Room Deodorizer**

- Absorbs and eliminates carpet and room odours
- Safe for carpet and vacuums; freshens the entire area
- Fresh lemon scent; biodegradable

<b>17122</b>	12 oz/340 g	12/cs	12 lb
--------------	-------------	-------	-------

### **C Super Odor Eliminator**

- Instantly & effectively eliminates odours on and from fabrics, drains, air, pet areas, bedding, carpets, gym bags, etc.
- Easy to use; spray trigger is attached to each bottle
- Environmentally friendly
- Biodegradable/low VOC formula; free from harmful chemicals
- Safe for use around kids and pets (except birds)

<b>632SOE</b>	946 mL/32 oz	6/cs	15 lb
---------------	--------------	------	-------

### **D Conqueror 103 Odor Counteractant Concentrate**

- Higher fragrance than leading RTU brands
- Use full strength on problem areas
- Use on hard surfaces, carpets, in mop water, fogging applications, laundry or other water-based solutions
- Phosphate free, biodegradable; safer for the environment
- Also available in 1, 5 and 55 gallon drums. Contact your rep for details and pricing

<b>10332HM</b>	Herbal Mint	946 mL/32 oz	12/cs	29 lb
<b>10332MG</b>	Mango	946 mL/32 oz	12/cs	29 lb
<b>10332CM</b>	Cucumber Melon	946 mL/32 oz	12/cs	29 lb

### **E Smoke Eliminator Heavy Duty Odor Eliminator**

- Ready-to-use formula
- Especially formulated to eliminate smoke and heavy duty odours
- Contains a highly concentrated fragrance and a powerful, patented neutralizer to effectively eliminate odours at the source
- Use full strength on carpets, mattresses, upholstery, other fabrics
- Can be diluted for fogging and light duty cleaning of walls, floors and other hard surface

<b>10432</b>	946 mL/32 oz	6/cs	15 lb
<b>1041</b> ♦	3.78 Litres/1 US gal	4/cs	37 lb

### **F Bio Conqueror 105 Enzymatic Concentrate**

- Concentrated formula; high fragrance, surfactants and bacterial concentrations work quickly to clean and eliminate odours at their source
- Use full strength or diluted without sacrificing any performance
- Ideal for most odour problems; pet messes on carpets, smelly grout around urinals/toilets, dumpsters and foul smelling drains
- Also available in 1, 5 and 55 gallon drums. Contact your rep for details and pricing

<b>10532HM</b>	Herbal Mint	946 mL/32 oz	12/cs	29 lb
<b>10532MG</b>	Mango	946 mL/32 oz	12/cs	29 lb
<b>10532CM</b>	Cucumber Melon	946 mL/32 oz	12/cs	29 lb

**C**



**D**



**E**



**F**



## Floor Care Products

### A Enviro Care® Low Foam All Purpose Cleaner

- Effective for many routine cleaning jobs
- Highly concentrated yet gentle on hands; requires no rinsing and leaves a fresh clean fragrance
- Specially formulated for compatibility with any floor finish; will not damage or dull floor finishes or waxes
- Contains no butyl cellosolve or alkalis
- Phosphate free and biodegradable
- No added fragrances, non-corrosive, contains no hazardous ingredients

11822014	32 oz/946 mL Enviro Container	6/cs	14 lb
11822036	1 US gal/3.78 L	4/cs	36 lb

### B Enviro Care® Enhancer

- Maintains floor finish
- Cleans, conditions and restores the wet look gloss of all acrylic-based floor finishes
- High-dilution concentrate can be applied with an automatic scrubber or damp mop
- Biodegradable
- Phosphate free and no added fragrance; non-corrosive

11904136	1 US gal/3.78 L	4/cs	37 lb
----------	-----------------	------	-------

## Floor Stripper

### C Enviro Care® Floor Stripper

- Formulated to remove all types of floor finishes
- Highly concentrated; low foaming
- Instantly whitens by re-emulsifying
- Apply the floor stripper and watch the coating whiten as it penetrates and dissolves the finish and waxy build up
- Biodegradable; phosphate free with no added fragrance

11904040	2.5 US Gal/9.5 L	2/cs	46 lb
----------	------------------	------	-------

### D Thermo-Strip Floor Stripper

- Low odour floor finish remover designed to combine stripping power and user-friendly technology
- Removes sealers and floor finishes hardened by frequent burnishing
- Non-ammoniated
- Easily removes the toughest coatings

11259039	1 US gal/3.78 L	4/cs	39 lb
----------	-----------------	------	-------



❖ Non-stocked item requires special order





## Floor Finish

### A Thermo Gloss Floor Finish

- Bright floor finish and protection
- Provides an instant brilliant gloss that becomes deeper and tougher each time it is burnished
- Suitable for use on vinyl, vinyl asbestos, linoleum, asphalt, rubber and terrazzo floors
- More durable and scuff resistant than other "burnishable" finishes

11256839	1 US gal/3.78 L	4/cs	39 lb
----------	-----------------	------	-------

### B Enviro Care® Novus Floor Finish

- Neutral pH; readily biodegradable
- No Heavy Metal Complexes, APE's, Formaldehyde
- No odour, non-corrosive and non-reactive
- Combines an unequaled level of environmental preference with performance, which surpasses conventional floor finish technology
- Excels with all maintenance systems: scrub and recoat, spray buff or burnish
- Provides a tough, black-mark resistant shine with no powdering; no sealer required on resilient flooring, even after heavy stripping

11927040	2.5 US Gal/9.5 L	2/cs	46 lb
----------	------------------	------	-------



## Concrete Cleaner/Protector

### C Enviro Care® Conseeal Concrete/Stone Protector

- Protects and beautifies decorative as well as functional floors
- Apply to light, moderate or heavy traffic areas and be ready to use those areas in as little as 4 hours
- No fumes and no special respiratory equipment needed
- No nonyl phenol ethoxylates or phosphates
- No heavy metal complexes
- No added fragrances, non-corrosive and non-reactive
- Water based; Low VOC's

12000440	2.5 US Gal/9.5 L	2/cs	46 lb
----------	------------------	------	-------



## Absorbents

### D Super-Sorb Instant Absorbent

- Absorbs 60 times its' own weight in liquid
- Instantly absorbs any liquid mess and transforms it into a manageable gel
- Effective on urine, blood, vomit, oil and liquid spills
- Simple to use - just sprinkle on liquid, then sweep up gel
- Contains microbicide to prevent spoilage

17128	12 oz/340 g	6/cs	4.5 lb
17127	5 US gal/19 L	1 Pail	21 lb

### E Stain-Sorb Liquid Stain Absorbent

- A unique liquid stain absorbent and remover
- Highly effective against oils, greases, BBQ grill stains, silicone oils from tire dressings and other stains
- Ideal for use on asphalt, concrete, paving stones, pressure treated wood, composite decking and other surfaces
- Easy to apply by pouring, spraying or brushing onto stained surfaces
- Quickly dries to a powder for easy removal; no scrubbing or rinsing necessary
- Biodegradable

15912	32 oz/946 mL	12/cs	30 lb
-------	--------------	-------	-------



# Trigger Sprayers & Bottles

## General Purpose Trigger Sprayers

### A General Purpose Trigger Sprayers

- Save 20% - 40% while maintaining resistance to common janitorial chemicals
- Use for restroom and window cleaning, housekeeping, in car washes, for auto detailing, pest control, lawn care
- 1.1 mL output per stroke
- Fits 28 mm - 400 thread finish; adjusts from pin to mist spray

<b>6110RW</b>	7¼"	Red/White	200/cs	18 lb
<b>6111RW</b>	8"	Red/White	200/cs	18 lb
<b>6111BW</b>	8"	Blue/White	200/cs	18 lb
<b>6112RW</b>	9¼"	Red/White	200/cs	18 lb
<b>6112BW</b>	9¼"	Blue/White	200/cs	18 lb

### B General Purpose Shipper Sprayers

- Ergonomic grip
- Engineered not to leak if bottle tips over
- Three-finger trigger and rear support makes extended use more comfortable
- Self-venting to prevent bottle collapsing
- 1.4 mL output per stroke significantly reduces the number of times you pull the trigger
- Fits 28 mm - 400 thread finish; adjusts from pin to mist spray

<b>7111RW</b>	8"	Red/White	200/cs	18 lb
<b>7111BW</b>	8"	Blue/White	200/cs	18 lb
<b>7112RW</b>	9¼"	Red/White	200/cs	18 lb
<b>7112BW</b>	9¼"	Blue/White	200/cs	18 lb

### C General Purpose Trigger Sprayer

- **Leading general purpose trigger sprayer in the janitorial and industrial markets**
- Rubber piston cup extends life and provides broader chemical resistance while the outer body protects the piston assembly to prevent damage during use and storage
- Use for restroom and window cleaning, housekeeping, in car washes, for auto detailing, pest control, lawn care
- 1.4 mL output per stroke
- Fits 28 mm - 400 thread finish

<b>5111RW</b>	8"	Red/White	200/cs	20 lb
<b>5111BW</b>	8"	Blue/White	200/cs	20 lb
<b>5112RW</b>	9¼"	Red/White	200/cs	20 lb
<b>5112BW</b>	9¼"	Blue/White	200/cs	20 lb

### D Economy Shipper Trigger Sprayer

- Great value; cost effective shipper-style trigger sprayer
- Engineered not to leak when shipped on bottles containing liquids
- Contemporary, rugged design has retail appeal
- Nozzle can be set to spray or off
- Applications: packaging, shipping, general use
- 0.7 mL output per stroke
- Fits 28 mm - 400 thread finish

<b>100WW</b>	9¼"	White/White	500/cs	30 lb
--------------	-----	-------------	--------	-------

### E Valu-Shipper Trigger Sprayer

- Non-leaking and versatile
- Nozzle can be set to mist, spray, or off
- Low profile design gives product a retail appearance
- 0.8 mL output per stroke
- Fits 28 mm - 400 thread finish

<b>200WW</b>	9¼"	White/White	200/cs	22 lb
--------------	-----	-------------	--------	-------



## General Purpose Trigger Sprayers

### A Standard Trigger Sprayer

- Adjusts from pin to mist spray
- 1.1 mL output per stroke
- Fits 28 mm - 400 thread finish

11T	7¼"	Red/White	200/cs	18 lb
-----	-----	-----------	--------	-------

### B Upside Down Trigger Sprayer

- Works From Any Angle
- Patented design allows you to use the sprayer in any direction... even completely upside down!
- Unique design allows user to completely empty contents of the bottle
- Non-leaking
- Use for restroom cleaning, housekeeping, window cleaning, in car washes, for auto detailing, pest control, lawn care
- 1.0 mL output per stroke
- Fits 28 mm - 400 thread finish

110450	9¼"	White	200/cs	18 lb
--------	-----	-------	--------	-------

### C Smazer™ General Purpose Trigger Sprayers

- Ergonomic, 3-finger grip
- No leak design
- Two-piece piston design for better chemical resistance
- 1.4 mL output per stroke
- Fits 28 mm - 400 thread finish

4800WW	8"	White/White	250/cs	22.5 lb
4802BW	8"	Blue/White	250/cs	22.5 lb
4806RW	8"	Red White	250/cs	22.5 lb
4900WW	10"	White/White	250/cs	22.5 lb
4902BW	10"	Blue/White	250/cs	22.5 lb
4906RW	10"	Red White	250/cs	22.5 lb



## Chemical Resistant Trigger Sprayers

### D Chemical Resistant Shipper Sprayer

- Adjustable spray pattern and full off position
- Fits 28 mm - 400 thread finish

902PW9	9¾"	White	200/cs	22 lb
--------	-----	-------	--------	-------

### E Chemical Resistant Trigger Sprayer

- 5112CR is formerly the #110542
- Nozzle O-ring and piston cup are made of chemical resistant synthetic rubber
- Ergonomically designed extra long trigger provides unsurpassed comfort
- Extra large spray pattern
- 1.4 mL per stroke
- Fits 28 mm - 400 thread finish

5111CR	8"	Grey	200/cs	22 lb
5112CR	9¼"	Grey	200/cs	22 lb



❖ Non-stocked item requires special order



## Acid Resistant Trigger Sprayer

### A Acid Resistant Trigger Sprayer

- Not intended for use with solvent solutions
- Unsurpassed acid resistance; proprietary design extends product life when used with acid solutions
- Outer body protects piston assembly to prevent damage during use and storage
- Designed specifically to be used with acid-based wheel cleaners
- 1.4 mL output per stroke significantly reduces the number of times you pull the trigger
- Fits 28 mm - 400 thread finish

5111AR	8"	Gold/Black	200/cs	22 lb
5112AR	9¼"	Gold/Black	200/cs	22 lb

## Foaming Trigger Sprayers



### B Foamer Trigger Sprayer

- Three-finger trigger and rear support makes extended use more comfortable
- Foaming action helps reduce the consumption of chemicals
- 1.4 mL output per stroke significantly reduces the number of times you pull the trigger
- Fits 28 mm - 400 thread finish

9111WF	8"	White	200/cs	18 lb
9112WF	9¼"	White	200/cs	18 lb

### C Sprayer/Foamer Combo Trigger Sprayer

- Combines the features of two sprayers into one
- Sprays rich foam or screen flips back allowing trigger to spray as a regular spray
- Three-finger grip
- No leak design
- 28mm/400 thread neck finish

7029	10"	White	270/cs	18.5 lb
------	-----	-------	--------	---------



### D High Output Trigger Sprayer

- Self-venting to prevent bottle collapsing
- Oversized trigger for 3 finger activation, prevents hand fatigue
- Over 3 times normal output per stroke, 3.2 mL
- Fits 28 mm - 400 thread finish

8112RW	9½"	Red/White	100/cs	17 lb
--------	-----	-----------	--------	-------

## Trigger & Bottle Complete

### E Standard Trigger Sprayer Complete

- Combo pack of (50) 11T sprayers and (50) 11B bottles
- Bulk packed in a carton

11	Red/White	50/cs	10 lb
----	-----------	-------	-------

### LEGEND

#### Tube Lengths:

- 7¼" fits 16 oz bottle
- 7¼" - 7½" fits 22 oz Colossal bottle
- 8" - 8⅛" fits 24 oz bottle
- 9¼" - 10" fits 32 oz bottle

## Bottles

### A 32 oz Handi-Hold Bottle

- Without graduations, 28 mm/400 neck finish
- Made with high density polyethylene

17425	32 oz	Natural	92/cs	12 lb
-------	-------	---------	-------	-------

### B 32 oz Handi-Hold & W.H.M.I.S. Bottle

- Without graduations
- High density polyethylene with screened red W.H.M.I.S. panel
- 28 mm/400 neck finish

29223	32 oz	Natural	92/cs	12 lb
-------	-------	---------	-------	-------

### C 32 oz Round Bottle

- Moulded oz/mL and dilution ratios
- High density polyethylene, 28 mm/400 neck finish

932C	32 oz	Natural	100/cs	16 lb
------	-------	---------	--------	-------

### D 24 oz Round Bottles

- Moulded oz/mL and dilution ratios
- High density polyethylene, 28 mm/400 neck finish

12174	24 oz	Natural	105/cs	10.5 lb
-------	-------	---------	--------	---------

### E 24 oz Round W.H.M.I.S. Bottle

- Moulded oz/mL and dilution ratios
- High density polyethylene with screened red W.H.M.I.S. panel
- 28 mm/400 neck finish

29036	24 oz	Natural	100/cs	8 lb
-------	-------	---------	--------	------

### F 16 oz & 32 oz Cylinder Bottle

- Without graduations, 28 mm/400 neck finish
- Round and sleek for great shelf presence
- Easy to decorate, fill and pack

17102	16 oz	Natural	180/cs	19 lb
-------	-------	---------	--------	-------

17104	32 oz	Natural	144/cs	12 lb
-------	-------	---------	--------	-------

### G 22 oz Colossal Bottle

- Moulded oz/mL and dilution ratios, 28 mm/400 neck finish
- High density polyethylene

11B	22 oz	Natural	120/cs	10 lb
-----	-------	---------	--------	-------

## Bottle Top Accessories

### H Loc Top Dispenser Caps & Bottle Caps

- 28 mm/400 neck finish, fits all spray bottles

12014	Loc Top	White	100/pk	1 lb
-------	---------	-------	--------	------

17115	Bottle Cap	White	100/pk	1 lb
-------	------------	-------	--------	------

❖ Non-stocked item requires special order





# Enviro Care®

Sustainable solutions for health,  
productivity and the environment.





# Pumps & Sprayers



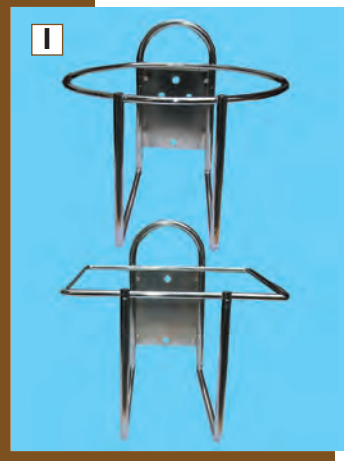
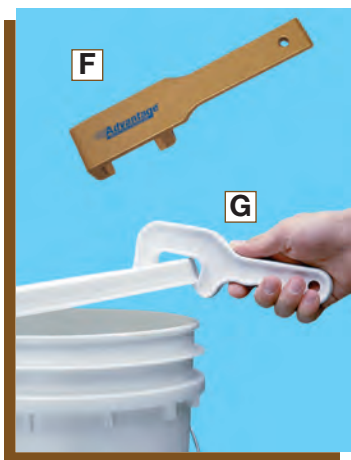
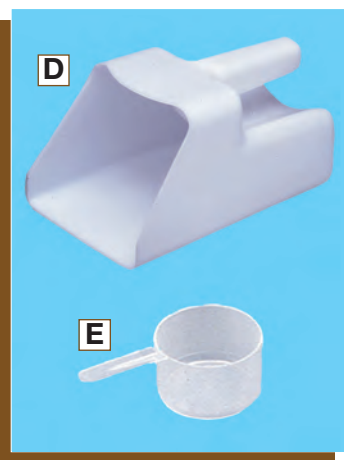

## Measuring Cups & Scoops

### A Econo 8 oz Measuring Cup

- An economy 8 oz. utility plastic cup
- Calibrated ounce and millilitre scales

<b>2418</b>	Translucent	8 oz/237 mL	Sold ea	0.5 lb
-------------	-------------	-------------	---------	--------

### B Econo 16 oz Measuring Cup

- An economy 16 oz. utility polypropylene cup
- Liquid and dry measurements with graduations

<b>2416</b>	Translucent	16 oz/473 mL	Sold ea	0.1 lb
-------------	-------------	--------------	---------	--------

### C Plastic Funnels

- Translucent
- Dimensions of 5408: 4¼" Dia. x 4¼" H
- Dimensions of 5416: 5" Dia. x 5¾" H

<b>5408</b>		8 oz/237 mL	Sold ea	0.01 lb
<b>5416</b>		16 oz/473 mL	Sold ea	0.01 lb

### D Deluxe Scoop

- Large capacity polypropylene scoop

<b>2405</b>	White	2 Quart/1.9 L	12/cs	13 lb
-------------	-------	---------------	-------	-------

### E Econo Measuring Scoops

<b>2401</b>	Translucent	1 oz/30 mL	Sold ea	0.01 lb
<b>2402</b>	Translucent	2 oz/59 mL	Sold ea	0.01 lb

## Storage Accessories

### F Lid Off

- Lifetime guarantee
- 110 Metal fits most plastic pails

<b>110</b>	Metal		12/cs	6 lb
------------	-------	--	-------	------

### G Plastic Pail Lid Opener

- Removes lids from pails and buckets, ideal for foodservice
- Works effectively without cutting or distorting container
- Dimensions: 8" L x 1¼" W x 2¾" H

<b>7210</b>	White		24/cs	5 lb
-------------	-------	--	-------	------

### H Wall Mount Storage Bracket

- Epoxy coated steel wire resists corrosion
- Great for storing concentrates used with proportioners
- Holds 3 round US gallon, 4 F-style, square US gallons or 4 litre containers
- Dimensions: 7" D x 25" W x 9" H

<b>200194</b>	Grey		1/cs	3.5 lb
---------------	------	--	------	--------

### I Wall Brackets

- Rigid, silver powder-coated ¼" wire
- Excellent for holding litre and gallon containers
- Dimensions for **801**: 4¼" D x 6¾" W x 6" H

<b>801</b>	Round	Chrome	12/cs	10 lb
------------	-------	--------	-------	-------

- Dimensions for **804**: 4" D x 5¾" W x 5¾" H

<b>804</b>	Square	Chrome	12/cs	10 lb
------------	--------	--------	-------	-------

### J Bag Filling Station for Mopster

- Allows easy filling Chemical Storage Bags (LBH18CSB) from 5 gallon pails and popular bag-in-box chemical containers

<b>LBH18BFS</b>	Filling Station for 5 gal pails		1/cs	2.8 lb
-----------------	---------------------------------	--	------	--------

## Portion Aids & E-Z Fill™

### A 28 mm - 38 mm Portion Aids

- Gives accurate measurements and eliminates waste
- Use with cleaners, disinfectants, detergents or concentrates
- Ounce and cc calibrations silk screened on sides
- Cup size 3 oz/89 mL
- Dimensions for **3528**: 12" L x 2" D x 3" H; for quarts
- Dimensions for **3538**: 15" L x 2" D x 3" H; for gallons

<b>3528</b>	Translucent	Fits 28 mm neck	12/cs	1 lb
<b>3538</b>	Translucent	Fits 38 mm neck	12/cs	1 lb

### B Pro-Blend Portion Aids

- Just turn the top clockwise to raise or counter-clockwise to lower the regulator
- Squeeze the bottle to fill; any excess liquid will flow back into the bottle
- Open the safety cover and pour out the measured liquid
- Reduces product waste and ensures fast easy measuring

<b>200309</b>	28 mm/400 neck for 32 oz bottles	12/cs	1.8 lb
<b>200308</b>	38 mm/400 neck for gallon bottles	12/cs	2 lb

### C E-Z Fill® 5 Gallon Polyethylene Container

- User friendly for E-Z filling and pouring of product
- Heavy-duty container, 63 mm angled front opening for filling of ready-to-use chemical concentrates
- 38 mm top vent opening accepts standard 3/4" tubing
- Includes **7577** faucet with 38 mm cap, has no leak, tight fit with easy on/off handle, spout fits into 28 mm bottle neck
- Half gallon embossed graduations on top and front
- Dimensions: 16" L x 10" W x 10" H

<b>7576</b>	Translucent	6/cs	11 lb
-------------	-------------	------	-------

### D E-Z Fill® 2 1/2 Gallon Polyethylene Container

- Same features as 7576
- Dimensions: 16" L x 5" W x 10" H

<b>7572</b>	Translucent	12/cs	12 lb
-------------	-------------	-------	-------

## Faucets & Drum Accessories

### E Faucet for 7576 and 7572 E-Z Fill® Containers

- No leak design, has easy on/off operation
- Fits 38mm (1 1/2") neck finish
- Dimensions: 1 1/4" L x 1 5/8" W x 3" H

<b>7577</b>	White	Sold ea	0.5 lb
-------------	-------	---------	--------

### Drum Spigots

- Made of FDA approved virgin polyethylene
- Handles viscous materials
- Not affected by most acids, caustics or oil
- Instant on/off control

### F Drum Spigot for 2" Bung Opening

<b>4200</b>	Bronze	24/cs	17 lb
-------------	--------	-------	-------

### G Drum Spigot for 3/4" Bung Opening

<b>4205</b>	Bronze	24/cs	2.5 lb
-------------	--------	-------	--------

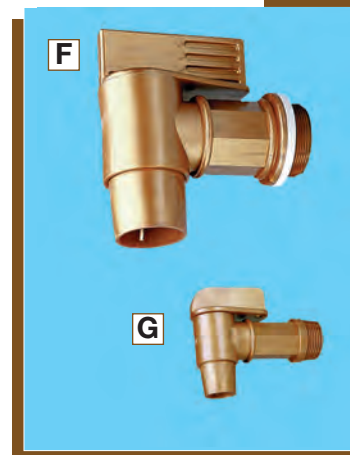
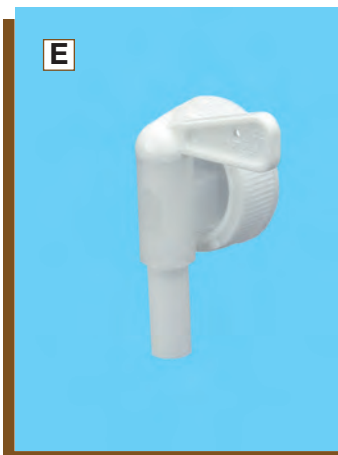

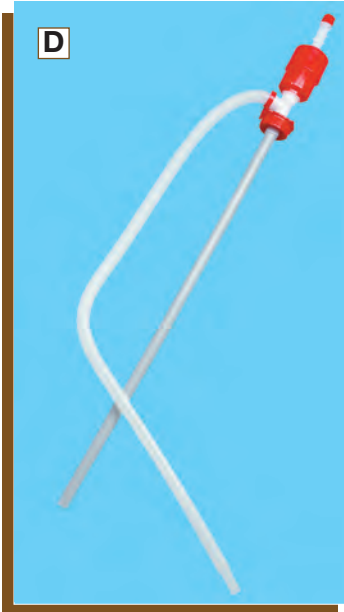

## Plastic & Metal Pumps

### A 8 oz Drum Pump With 20 Litre Pail Adapter

- Pumps 8 oz or 2, 4 or 6 oz (237, 59, 118 or 177 mL) with restriction clips included
- Special pail adapter fits 5 or 6 gallon pails with Senior Rieke FlexSpout
- Fits 55 gallon drums with 3/4" or 2" standard F.I.P. fittings
- O-ring for better seal. Adapts to both 3/4" and 2" National Pipe Thread
- Polypropylene and polyethylene construction for chemical resistance
- Dimensions: 2" D x 11" H

2200BL	Blue	12/cs	12 lb
--------	------	-------	-------

### B 2204 22 oz Metal Drum Pump

- Pumps 22 oz/651 mL per stroke
- Fits 15, 30 and 55 gallon drum with 1 1/2" and 2" National Pipe Thread
- Self-priming, nickel plated pump
- Dimensions: 1 1/2" D x 8" W x 42 1/2" H

2204	Silver	6/cs	26 lb
------	--------	------	-------

### C 2208 8 oz Metal Drum Pump

- Dispenses 8 oz/237 mL per stroke
- Fits 15, 30 and 55 gallon drum with 2" National Pipe Thread
- Chrome plated pump
- Dimensions: 1 1/8" D x 9" W x 24" H

2208	Chrome	12/cs	19 lb
------	--------	-------	-------

## Siphon Pumps

### D Siphon Drum Pump

- Made from polyethylene for 15, 30 and 55 gallon drums
- For standard drums with 2" National Pipe Thread
- Dimensions: 3" D x 45" H

2300	Red	6/cs	11 lb
------	-----	------	-------

### E Mini Siphon Pump

- Comes with adapter for use with Rieke Intermediate plastic FlexSpout on 20 L pails
- When used with Rieke Jr. FlexSpout, remove adapter
- Dimensions: 2" D x 21" H

2305	Red	24/cs	7 lb
------	-----	-------	------

### F Heavy-Duty Siphon Pump

- For rugged, heavy use applications
- Siphons 7 gallons per minute
- Use with 205 L drums with 2" National Pipe Thread
- Dimensions: 3 1/2" D x 47" H

2307	Red	24/cs	28 lb
------	-----	-------	-------

❖ Non-stocked item requires special order

## Dispensing Pumps

### A 901 Deluxe 1 oz Dispensing Pump

- 1 oz/30 mL with 38 mm cap and 11" tube length
- Non-removable cap with calibrated plunger
- Fits 4 litre container and standard gallon
- Recommended for most products including chemicals and some pumice type soaps
- Dimensions: 17" L x 4 3/8" spout

901	White	24/cs	5 lb
-----	-------	-------	------

### B 901A Deluxe Plastic 1 oz Pail Pump

- 1 oz/30 mL calibrated plunger with 17" tube length
- Fits 20 L/5 gal pails with Senior Rieke Adapter
- Dimensions: 22 1/2" L x 4 3/8" spout

901A	White	24/cs	4 lb
------	-------	-------	------

### C 902A Special 1/8 oz Plastic Pump

- 1/8 oz/4 mL with 38 mm locking cap and 11" tube length
- Fits 4 L container and standard gallon
- Good for hand soaps; very economical
- Dimensions: 17" L x 3" spout

902A	White	24/cs	2 lb
------	-------	-------	------

### D 904 Econo 1 oz Dispensing Pump

- 1 oz/30 mL with 38 mm cap and 10 3/4" tube length
- Removable cap without calibrated plunger
- Plunger locks down for reduction of leaks during shipping and storage
- Fits 4 litre container and standard gallon
- FDA and USDA accepted for food applications and disinfectants
- Dimensions: 17" L x 4 3/8" spout

904	White	24/cs	5 lb
-----	-------	-------	------

### E 904A Econo Plastic 1 oz Pail Pump

- 1 oz/30 mL with 38 mm cap and 17" tube length
- Plunger locks down for reduction of leaks during shipping and storage
- Removable cap without calibrated plunger
- Fits 20 L/5 gal pails with Senior Rieke Adapter
- FDA and USDA accepted for food applications and disinfectants
- Dimensions: 22 1/2" L x 4 3/8" spout

904A	White	24/cs	5 lb
------	-------	-------	------

### F 906A Special 1/16 oz Plastic Pump

- 1/16 oz/2 mL with 28 mm locking cap and 9" tube length
- Fits standard 28 mm quart and pint bottles
- Dimensions: 11" L x 2 1/2" spout

906A	White	24/cs	2 lb
------	-------	-------	------

## Plastic Pump Kit

### G 905 1 oz Plastic Pump Kit with 904 Econo Pump

- For use with various neck sizes on different gallon containers (mustard, ketchup, etc.)
- Fits 4 litre container and standard gallon
- Great for food service and other institutional uses
- Includes plastic caps, sizes 89 mm, 110 mm and 120 mm
- Dimensions: 10 3/4" L tube

905	White	24/cs	6 lb
-----	-------	-------	------

◆ Non-stocked item requires special order

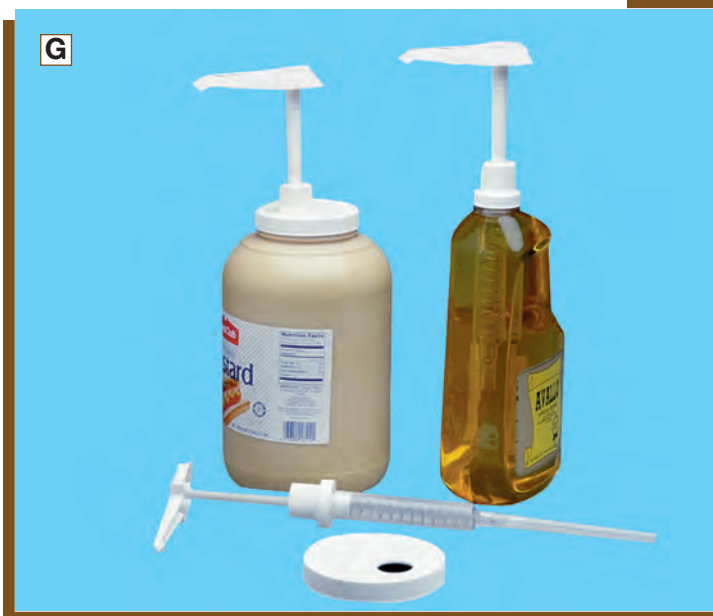
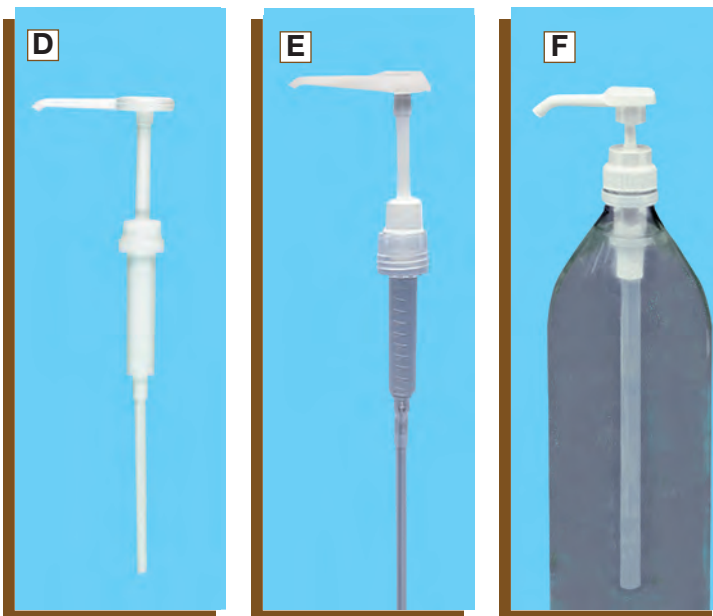
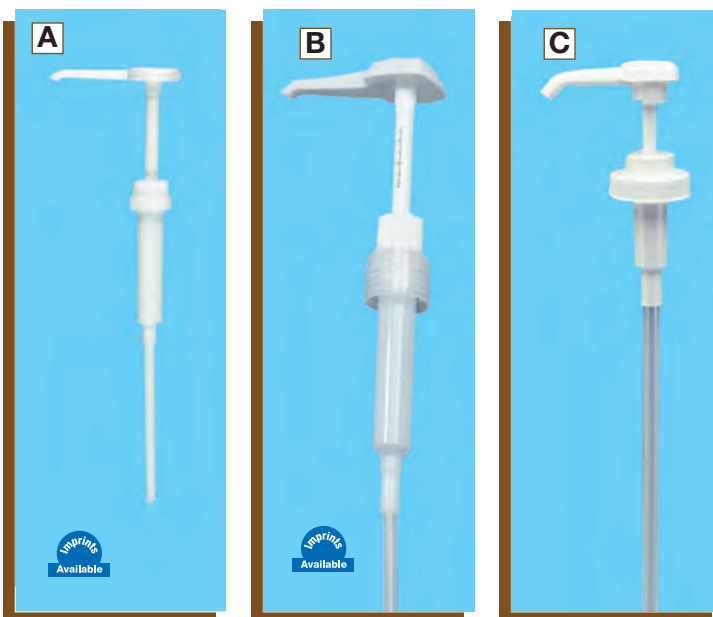



## Industrial Sprayers

### A Multi-Purpose™ Sprayers

- The most economical for pro use
- Ideal for medium duty use, including spraying water during asbestos removal
- Stable, 6-footed translucent tank with funnel top
- Large, poly TOV™ thumb-operated control valve with in-line filter
- 18" curved poly spray wand (20012, 20013)
- 12" curved poly spray wand (20011)
- Cluster™ nozzle with four selectable spray patterns; fan, flooding fan, cone or foam
- HPP™ High Performance Pump with glove-sized comfort grip handle

20011TS	1 US Gal/4 L	1/cs	4 lb
20012TS	2 US Gal/8 L	1/cs	4 lb
20013TS	3 US Gal/11 L	1/cs	4 lb

### B Professional Surface Applicators

- Best for spot spraying carpets, floors and walls
- Large, comfortable poly Thrustless™ control valve with in-line filter
- Chemical resistant 42" Kem-Oil™ braided power sprayer style hose
- Strong, curved brass 18" spray wand and brass flat fan nozzle
- HPP™ High Performance Pump with glove-sized comfort grip handle

90112	2 US Gal/8 L	1/cs	5 lb
90113	3 US gal/11 L	1/cs	5 lb

### C Super Sprayer

- Chemical resistant; **can be used with bleach**
- Stable, 6-footed translucent tank with large funnel top
- Kem-Oil™ 48" braided power sprayer style hose
- Large, comfortable poly Thrustless™ control valve with in-line filter
- 18" fiberglass/poly spray wand; locking pressure release valve
- Two professional style nozzles - both flat fan and cone
- HPP™ High Performance Pump with glove-sized comfort grip handle

90162	2 US Gal/8 L	1/cs	4 lb
-------	--------------	------	------

### D Foam-A-Matic Sprayer

- Applies cleaners, sanitizers and weed killers more effectively as foam
- Stable, 6-foot translucent tank with large funnel top
- Kem-Oil™ chemical resistant, braided power sprayer style hose
- 18" curved poly spray wand
- Comfortable, thumb operated locking TOV™ control valve
- Foaming action increases chemical effectiveness and saves money
- HPP™ High Performance Pump with glove-sized comfort grip handle

90192	2 US Gal/8 L	1/cs	4 lb
-------	--------------	------	------

### E Back Reliever Sprayer

- Features a 25" poly telescopic wand for extended reach
- Innovative pump handle extends to comfortable height during pressurization
- Manual pressure relief valve for safe release of pressure.
- Poly TOV™ thumb-operated control valve with an in-line filter

62192	2 US Gal/8 L	1/cs	4 lb
-------	--------------	------	------

## Pump Up Sprayers

### A Jr. Pump-Up Sprayer & Foamer

- Easy to use with convenient 48 oz capacity
- Increased chemical resistance with Viton seals
- Spray nozzle adjusts from mist to direct stream

7548	Grey/Translucent	6/cs	11 lb
------	------------------	------	-------

- 7549 Foamer has nozzle that adjusts from stream to foam spray

7549	Grey/Translucent	6/cs	11 lb
------	------------------	------	-------

### B Pump-Up Sprayer

- Ideal for carpet spot cleaning, restroom, car washes
- Large 2 quart capacity; Viton O-rings
- Has adjustable spray nozzle from mist to stream spray

7500	Grey/Translucent	6/cs	11 lb
------	------------------	------	-------

### C Pump-Up Foamer/Sprayer

- Same features as 7500 Pump-Up Sprayer
- Unique nozzle produces smooth, thick foam

7501	Grey/Translucent	6/cs	11 lb
------	------------------	------	-------

### D Multi-Purpose Hand Pump

- One litre, translucent tank
- Strong, quick-pressurizing pump
- Fully adjustable spray pattern

69101	Black/Translucent	6/cs	4.3 lb
-------	-------------------	------	--------

### E Full Function Power Sprayer

- Multi-functional; saves money
- One unit allows you to mist, stream, fan or foam your liquid

150299	Black/Metal	12/cs	24 lb
--------	-------------	-------	-------



## Wash Guns

- Metered mixing provides accurate dilution; unused chemical can be returned to the original container
- Durable all brass mixing head, metering stem and internal parts for long, trouble-free operation
- Wide mouth, chemical resistant polyethylene bottle

### F Foamaster Foam Cleaning Gun

- Accurately mixes and sprays thick, clinging foam chemicals
- Detachable handle provides a range of powerful rinsing spray patterns
- Controlled flow rate uniquely suited to foaming chemicals

75QGF	Fixed Ratio	6/cs	10.5 lb
-------	-------------	------	---------

### G Foamaster Multi-Ratio Cleaning Gun

- Same features as 75QGF, but with multi-ratio stem and deflector
- Multi-ratio dial has five mixing settings that can be set from 1/4 - 14 oz per gallon, depending on the viscosity of the chemical

75QGFMR	Multi-Ratio	6/cs	10.5 lb
---------	-------------	------	---------

### H Foam Gun

- 96 oz capacity; minimum 40 psi, maximum 85 psi
- Water pressure operated foam gun
- Powerful spray rinse when detaching bottle/foamer from handle
- Colour coded metering tips for dilution control

7504	Water Pressure Operated	1/cs	3 lb
------	-------------------------	------	------





## Wheeled Spray Wagon

### A Wheeled Spray Wagon

- Translucent tank with extra long 72" hose
- Dura Tuf™ Chemical Resistant Hose
- Large TOV™ control valve
- Comfortable, thumb operated, 18" poly spray wand
- Fan/cone Pic-A-Pattern™ nozzle system
- Rainsoft™ shower spray head
- HPP™ High Performance Pump with comfortable glove-sized handle
- Over-sized wide tread wheels for stability

92130	3 US Gal/11 L	1/cs	10 lb
-------	---------------	------	-------



## Bak-Pak® Sprayer

### B Bak-Pak® Sprayer

- Extra large fill opening prevents spills when adding chemicals
- 48" Kem-Oil™ chemical resistant, braided power sprayer style hose
- Locking large poly control valve - comfortable, thumb operated
- Extra Long 20" fiberglass/poly spray wand
- Bonus nozzle system with 4 different spray settings
- All Viton® seals and gaskets
- Powerful piston pump; left or right handed pumping action

13194	4 US Gal/15 L	1/cs	12 lb
-------	---------------	------	-------



## Atomizer/Fogger

### C Fog® Electric Atomizer Sprayer

- Ultra low volume mist
- Light weight, 2 gallon poly tank
- Carrying strap
- Operates on 110V AC power
- Outputs 20 - 50 microns particle size
- Adjustable output of 1.5 - 5.3 gallons per hour
- 100 foot shoot range
- For stationary use

99599	2 US Gal/8 L	1/cs	9 lb
-------	--------------	------	------

❖ Non-stocked item requires special order



# Window Cleaning Tools



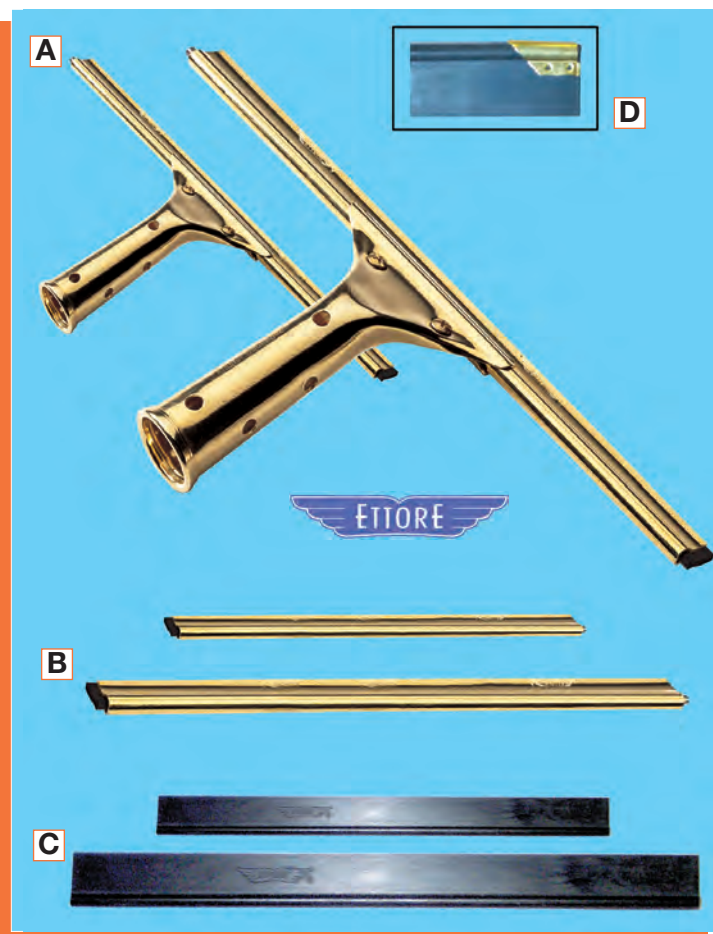

## Brass Squeegees

### A Master Solid Brass Squeegees Complete

- The top of our professional line
- Built to the precision tolerances you get with tempered, solid brass; perfect balance and weight

1013	12"	12/cs	6.5 lb
1017 ♦	14"	12/cs	7.0 lb
1021 ♦	16"	12/cs	7.5 lb
1025	18"	12/cs	8.0 lb

### B Master Brass Channels with Rubber

- Channels fit all handles on this page

1119 ♦	6"	12/cs	1.0 lb
1123 ♦	8"	12/cs	2.0 lb
1127 ♦	10"	12/cs	2.5 lb
1131	12"	12/cs	3.0 lb
1135	14"	12/cs	3.5 lb
1140	16"	12/cs	4.0 lb
1144	18"	12/cs	4.5 lb
1148 ♦	20"	12/cs	5.0 lb
1152 ♦	22"	12/cs	5.5 lb

### C Master Rubber for Channels

1397 ♦	6"	12/cs	0.5 lb
1402 ♦	8"	12/cs	0.5 lb
1407 ♦	10"	12/cs	0.5 lb
1412	12"	12/cs	0.5 lb
1417	14"	12/cs	0.5 lb
1422	16"	12/cs	0.5 lb
1427	18"	12/cs	0.5 lb
1432 ♦	20"	12/cs	0.5 lb
1438 ♦	22"	12/cs	1.0 lb
1443 ♦	36"	12/cs	2.0 lb

### D Brass Clips for All Window Squeegees

1253		12/pk	0.5 lb
------	--	-------	--------

### E Master Brass Handle

- Built to the precision tolerances you get with tempered, solid brass

1324		12/cs	3.5 lb
------	--	-------	--------

### F Quick Release Handle with Rubber Grip

- Change channels with a flick of your thumb
- Improve your reach by easily positioning channels off-centre
- The soft rubber handle means warmer hands and a better grip

1339		12/cs	3 lb
------	--	-------	------

### G Pro+ Super System Squeegee Handle

- Automatically adjusts to the angle you need without lifting it off the glass
- Makes easy work of odd-shaped glass and obstacles, speeding your window cleaning 30% to 50%

1640		12/cs	3.5 lb
------	--	-------	--------

### H Quick Release Aluminum Handle with Foam Grip

- Lightweight and easy to use
- The soft rubber handle provides a better grip

1405		12/cs	2.2 lb
------	--	-------	--------

## ErgoTec® Squeegees

### A ErgoTec® Ninja Squeegee Complete

- The most advanced window squeegee ever built
- Swivel and TriLock safety function
- Extruded Aircraft Aluminum T6 Channel is lightweight and will not bend
- Streak-free window cleaning featuring two sharp edges.

EN300	12"	5/cs	4.0 lb
EN350	14"	5/cs	4.3 lb
EN450	18"	5/cs	4.5 lb

### B ErgoTec® Ninja Aluminum Channel

- Complete with soft rubber and end clips

AC300	12"	5/cs	1.6 lb
AC350	14"	5/cs	1.8 lb
AC450	18"	5/cs	2.0 lb

### C ErgoTec® Ninja Endclips

- Left and right clip in one set
- Replacement end clips with adjustable rubber tension
- Easily changeable and protects the window frame

PPLUG	Black Endclips	5 sets	0.4 lb
-------	----------------	--------	--------

### D ErgoTec® Ninja Handle

- Two-component handle; perfect for pole work
- TriLoc for secure channel hold
- Locks on TelePoles with Unger Locking Cone

EN000	Handle	5/cs	2 lb
-------	--------	------	------

## Stainless Steel Squeegees

### E Stainless Steel Pro Squeegee Complete

- Complete with Quick Release Handle and Rubber Grip
- Bright annealed Stainless Steel has the advantage of lightness, strength and corrosion resistance

PR300	12"	10/cs	5.0 lb
PR350	14"	10/cs	5.5 lb
PR400	16"	10/cs	6.0 lb
PR450	18"	10/cs	6.5 lb

### F Stainless Steel Pro Squeegee Handle

- Stainless Steel has the advantage of lightness, strength and corrosion resistance
- Change channels with a flick of your thumb
- Improve your reach by easily positioning channels off-centre
- The soft rubber handle means warmer hands and a better grip

PR000		10/cs	3 lb
-------	--	-------	------

### G Replacement Channel with Soft Rubber

- Ideal for colder working environments
- Conforms to slightly uneven surfaces

NE300	12"	10/cs	2.0 lb
NE350	14"	10/cs	2.5 lb
NE400	16"	10/cs	3.0 lb
NE450	18"	10/cs	3.0 lb

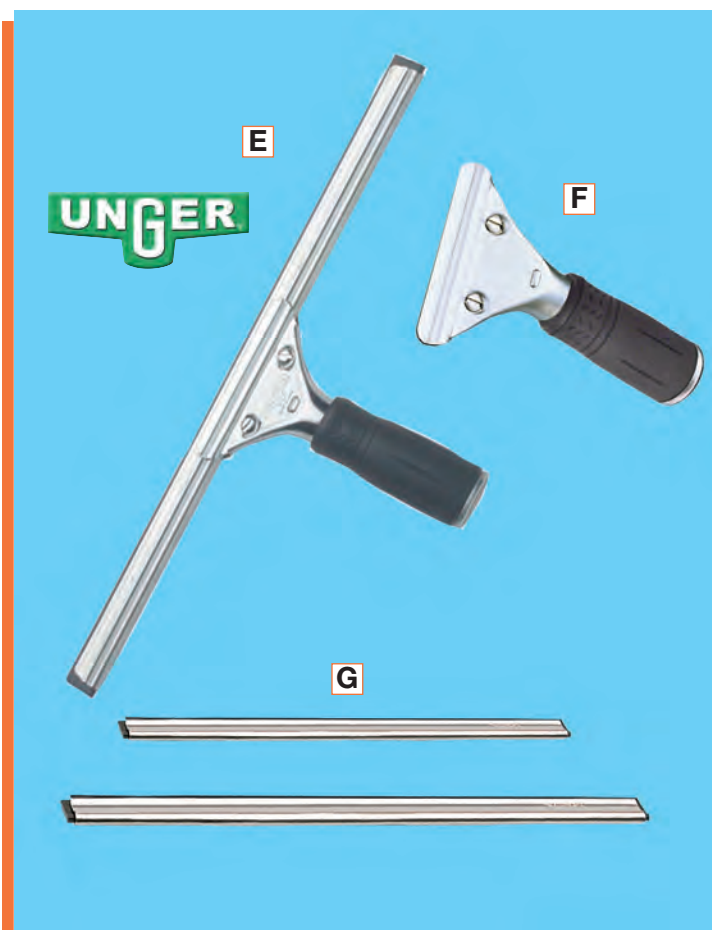



## Aluminum Squeegees

### A Aluminum Squeegees Complete

- Featherweight alternative to traditional brass
- Less fatigue with extended working time

3212	12"	12/cs	3.4 lb
3214 ♦	14"	12/cs	3.5 lb
3216 ♦	16"	12/cs	3.5 lb
3218	18"	12/cs	3.6 lb

### B Master Rubber for Channels

1912	12"	12/cs	1.4 lb
1914 ♦	14"	12/cs	1.6 lb
1916 ♦	16"	12/cs	1.9 lb
1918	18"	12/cs	2.0 lb

### C Aluminum Squeegee Handle

- Lightweight and easy to use
- Reduces user fatigue

1335		12/cs	1.7 lb
------	--	-------	--------

## Auto Squeegees

### D Auto Squeegee Scrubber

- Gentle scrubber with durable rubber squeegee
- Sponge is wrapped in honeycomb scrubbing nylon
- Easy to use - just scrub, flip and squeegee
- Comes with 20" handle, 10" Wide Head

9100		10/box	9.5 lb
------	--	--------	--------

### E Telescopic Squeegee

- Great for all your hard-to-reach cleaning demands
- A quick twist extends handle from 39" up to 64"
- Scrubbing sponge covered with durable nylon mesh
- Quality aluminum construction

9491		12/cs	14 lb
------	--	-------	-------



## All Purpose Squeegees

### F All Purpose Squeegee

- High impact plastic handle
- Lightweight and economical
- Streak-free rubber blade

17012	12"	24/cs	6 lb
17016	16"	24/cs	7 lb

### G Shower Sweep®

- Great for shower doors, tile and mirrors
- All plastic construction
- Won't scratch surfaces
- Suction cup for hanging

14100	White Plastic	12/cs	3.6 lb
-------	---------------	-------	--------

♦ Non-stocked item requires special order



## BackFlip

### A BackFlip - Four Tools In One!

- The perfect balance of speed and performance
- The channel is 2" longer than the washer. For example, the 71100 is made up of a 10" Golden Glove and a 12" squeegee
- With the simple touch of a button, transformed the BackFlip for a variety of applications: a One Pass Squeegee, combination Scrub & Squeegee or a separate Heavy-Duty Washer and Quick Release Squeegee
- Each tool fits on all Ettore extension poles
- The only tool that works in four time-saving combinations with no parts to lose

71100	10"	Brass	6/cs	7.5 lb
71140	14"	Brass	6/cs	8.5 lb
71180	18"	Brass	6/cs	9.5 lb

## Visa Versa

### B Visa Versa

- Strip washer and squeegee in one
- Quick spring release accepts Stainless Steel "S" Channels
- Features water wells with high water retention
- Heads can be offset to clean over ledges

VP250	◆	10"	Stainless Steel	10/cs	7.5 lb
VP350		14"	Stainless Steel	10/cs	12.0 lb
VP450		18"	Stainless Steel	10/cs	13.5 lb



## The SideKick

### C The SideKick

- A definitive dripless holster puts squeegee, washer and mini-bucket on either hip
- Detachable, quick-release belt clip (use 2044 tool belt)
- Durable, heavy duty construction
- Accepts all brands of squeegees and washers up to 18"
- Reversible right/left design
- Shown complete with tools, all items sold separately
- Dimensions: 4" D x 3¼" W x 12" H

02041		Black	6/cs	1.5 lb
-------	--	-------	------	--------



◆ Non-stocked item requires special order

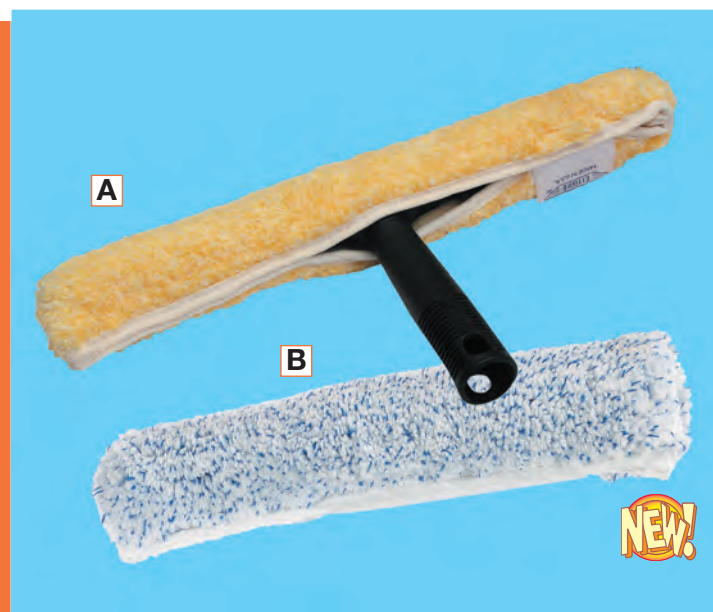

## Washers

### A Golden Glove

- Our most popular washer is built to last
- Extra heavy synthetic pile, double-twist fabric and double seams at the sewn ends

### Golden Glove Washers Complete

1814	10"	6/cs	2.5 lb
1816	14"	6/cs	3.0 lb
1818	18"	6/cs	4.0 lb

### Golden Glove Replacement Covers

51010	10"	10/cs	0.8 lb
51014	14"	10/cs	1.2 lb
51018	18"	10/cs	1.6 lb



### B Mighty Washer Sleeve

- Economical alternative with great performance
- Durable construction
- Machine washable

52010	10"	10/cs	0.8 lb
52014	14"	10/cs	1.2 lb
52018	18"	10/cs	1.6 lb



### C Original Strip Washer Complete

- Features plush, woven synthetic fabric with hook and loop fastening
- Strip washer handle included
- Gentle but strong
- Reinforced zigzag stitched ends ensure long life
- Excellent for cleaning windows, screens and dusting

WC350	14"	10/cs	3.0 lb
WC450	18"	10/cs	3.5 lb

### Original Replacement Sleeve

WS350	14"	10/cs	1.0 lb
WS450	18"	10/cs	1.5 lb

### D ErgoTec® Ninja Washer Complete

- Superior water retention and cleaning
- Built-in scrubbing bristles include microfibre
- Two abrasive pads provide extra scrubbing power
- Machine washable up to 500 times

NA350	14"	5/cs	4.5 lb
NA450	18"	5/cs	5.5 lb

### ErgoTec® Ninja Replacement Sleeve

NJ350	14"	5/cs	1.5 lb
NJ450	18"	5/cs	1.7 lb

❖ Non-stocked item requires special order

## High Access Poles

### A Aluminum Extension Poles

- Fluted aluminum design increases strength/rigidity; allows a better grip in wet conditions
- Combination friction fit and threaded tip for use with window washers and scrapers

8021	8'	2-section	10/cs	10 lb
8022	12'	2-section	10/cs	12 lb
8023	20'	3-section	10/cs	33 lb
8024	29'	3-section	10/cs	53 lb

### B OptiLoc Extension Poles

- Industry standard, drawn anodized aluminum extension poles
- Ergonomic handles improve worker comfort
- Fits a variety of tools
- Variety of 2 and 3 section poles (4 to 30 ft.)
- Nylon collars lock and loosen in one-half turn

#### 2-Section

EZ120	4'	10/cs	8 lb
EZ250	8'	10/cs	14 lb
EZ370	12'	10/cs	21 lb
EZ500	16'	10/cs	25 lb
EZ600	20'	10/cs	29 lb

#### 3-Section

ED370	12'	10/cs	23 lb
ED550	18'	10/cs	32 lb
ED600	20'	10/cs	35 lb
ED750	24'	10/cs	42 lb
ED900	30'	10/cs	50 lb

### C REA-C-H Extension Poles

- Heavy duty construction
- Fluted gold-anodized aluminum with high impact plastic tips prevents corrosion
- Tapered tip for dusting and painting
- Ergonomic cone and clamp assemblies
- Contoured grip for extended working time

#### 2-Section

42104	4'	6/cs	5 lb
42108	8'	6/cs	8 lb
42112	12'	6/cs	14 lb

#### 3-Section

1684	12'	6/cs	17 lb
1688	15'	6/cs	21 lb
1692	18'	6/cs	23 lb
1695	24'	2/cs	13 lb
1699	27'	2/cs	15 lb

For High Access Tools, see page 128

❖ Non-stocked item requires special order

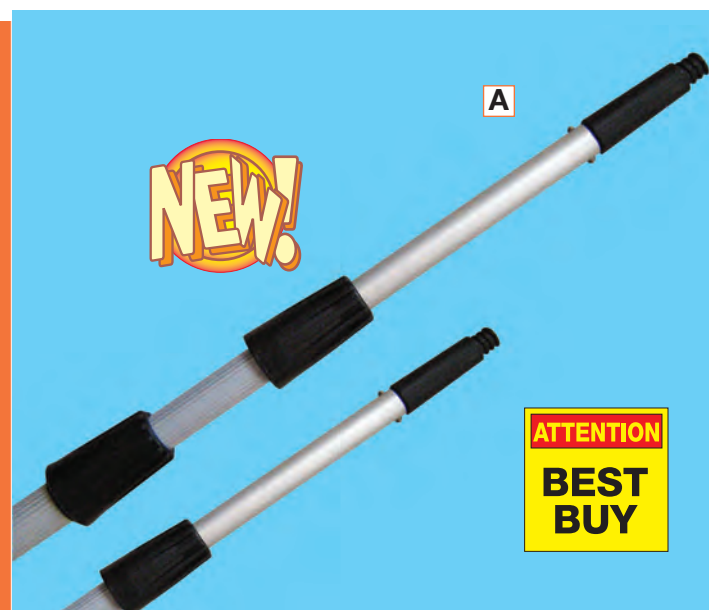



## Accessories

### A Super Bucket

- Indestructible soft-walled 6 gallon bucket
- Accommodates washers up to 18" long
- Options include convenient roll-around casters, drain-sieve and lid
- Dimensions: 19" L x 10" W x 10" H

<b>85000</b>	Super Bucket	6/cs	21 lb
<b>85100</b>	Snap-On Lid	1/cs	0.8 lb
<b>85200</b>	Casters	1/cs	0.9 lb
<b>85300</b>	Sieve	1/cs	1.0 lb

### B Utility Bucket with Sieve

- Strong 6 gallon/25 L bucket
- Accommodates washers up to 18" long
- Includes sieve insert and four non-marring, smooth-rolling casters
- Dimensions: 20" L x 10¼" W x 10½" H

<b>8014YE</b>	Yellow	5/cs	5.0 lb
<b>8016GY</b>	Grey Lid	Sold ea.	0.6 lb

### C Utility Bucket with Hanging Sieve

- Strong 6 gallon/25 L bucket
- Accommodates washers up to 18" long
- Includes hanging sieve to keep washer out of dirty water
- Comes with four non-marring, smooth-rolling casters
- Shown with 8016GY Lid (sold separately)
- Dimensions: 20" L x 10¼" W x 10½" H

<b>8017YE</b>	Yellow	5/cs	5.0 lb
<b>8016GY</b>	Grey Lid	Sold ea.	0.6 lb

## Screen Wipes

### D Clean Screens Wipes

- Moist towelettes clean without screen removal
- Also good for window blinds and ceiling fans
- Lint free technology
- Resealable pouch

<b>30155</b>	Screen Wipes, 25/pk	12/cs	6.5 lb
--------------	---------------------	-------	--------

❖ Non-stocked item requires special order

## Scrapers

### A Scrapemaster

- Wide double-edged Danish flex steel blades conform to the shape of the glass
- Light-weight handle and snap-on cover; scraper is easy to use

1995	4" Complete	6/cs	1.6 lb
1999	4" Replacement Blade	10/pk	0.1 lb

### B Metal Window Scraper

- Lightweight handle with snap-on blade cover; 9" L
- Dual edge blade conforms to the shape of the glass
- Friction fit handle for use with extension poles

8005	4" Complete	10/bg	2.8 lb
6009	4" Replacement Blade	10/pk	0.1 lb

### C Super Scrapers

- Durable; angled to get into the tightest corners
- Sharp and dull edges

57110	4" Complete	6/cs	4.0 lb
1992	6" Complete	6/cs	5.0 lb
6009	4" Blades	10/pk	0.1 lb
2031	6" Blades	10/pk	1.0 lb

### D Floor & Wall Scrapers

- Flexible, high carbon steel blade and durable handle
- Moulded handle with non-slip, ergonomic grip

860	1½" Blade	24/cs	3 lb
-----	-----------	-------	------

### E Safety Scraper

- Stainless steel scraper, 1½" blade
- Unique locking system eliminates blades from sliding out

SR500	1½" Blade	50/cs	6.5 lb
RRB100	Replacement Blade	100/pk	0.5 lb

### F Pocket Scrapers - Small Wonder

- Retractable blades
- This all-metal version takes standard single-edge blades

4286	Scraper (no blades)	12/pk	1.0 lb
RRB100	Replacement Blade	100/pk	0.5 lb

### G Coated Pocket Scraper

- Comfortable rubber coating prevents slips and allows the user to maintain a firm grip
- Retractable blades

8004	Scraper	12/cs	1.0 lb
RRB100	Replacement Blade	100/pk	0.5 lb

### H Sticky Fingers

- Fingers are 2/3 coated with rubber providing excellent turning power and ease of inserting bulbs
- Adjusts onto various shaped bulbs; attaches easily to all Unger poles

BS010		5/cs	1.5 lb
-------	--	------	--------

### I Fixi Clamp

- Made of fibreglass-reinforced nylon
- Quickly and easily grips sponges, rags, cloths, chamois and mop heads by simply tightening the locking collar
- Shown with Handi Brush, sold separately

FIXIO		5/cs	2.5 lb
-------	--	------	--------







## Floor Scrapers

### A Heavy-Duty Floor Scrapers

- Double edge blades – dull and razor sharp
- Perfect for removing tape, gum and grit from floors
- Reduces back and knee strain
- 4" angled head

2007	48" Handle	6/cs	9.0 lb
6009	4" Replacement Blades	10/pk	0.1 lb

### B Heavy Duty Floor Scrapers

- Heavy duty, light weight aluminum handle
- Carbon and steel blade comes with razor sharp and blunt edges
- Perfect for removing gum, tape and grit

8006	4" Blade, 12" L	6/cs	2.4 lb
8007	4" Blade, 9" L	6/cs	2.4 lb
6009	Replacement Blades	10/pk	0.1 lb

### C 4" Light Duty Scraper

- For light duty jobs
- Lightweight, aluminum 48" long, 0.83" diameter handle with ergonomic grip and hanging hole
- 4" angled zinc alloy head removes gum, stickers and wax build-up

LH12C	48" Handle	10/cs	10 lb
6009	Replacement Blades	10/pk	0.1 lb

### D 8" Heavy Duty Scraper (Telescopic)

- For heavy duty jobs
- Telescopic steel handle, extends from 3 to 5 feet
- 1.13" diameter galvanized steel handle with ergonomic grip
- 8" angled zinc alloy head for stripping tile floors, removing carpets and heavy-duty adhesives

HDSCO	3' to 5'	5/cs	10 lb
HDSBO	Replacement Blades (10/pk)	5 pk/cs	1.0 lb

### E ErgoTec® Scrapper

- Comfortable ergonomic scrapper with non-slip bi-component rubber grip
- Reversible tempered 4" carbon steel blade has blunt edge for cement or stucco work
- A razor edge for scraping paint and tape
- Handle easily attaches to all Unger poles, new ergonomic grip
- Comes with protective cap for blade

SH00C	6" Handle	10/cs	3.5 lb
6009	4" Replacement Blade	10/pk	0.1 lb



# Safety Products



## Plastic Safety Signs

- Yellow sign with black and red message attracts immediate attention
- Bilingual English/French
- Rugged, durable and portable
- Folds flat for space saving
- Dimensions: 12" W x 24" H

### A Caution Wet Floor Safety Sign

710CWF	Caution Wet Floor	6/cs	11 lb
--------	-------------------	------	-------

### B 710 Safety Signs

710-OM	Cleaning in Progress	6/cs	11 lb
710-OM	No Entry	6/cs	11 lb
710-OM	Out of Service	6/cs	11 lb
710-OM	Caution Work Area	6/cs	11 lb
710-OM	Caution	6/cs	11 lb



## 3-Sided Safety Cone

### C TriVu™ 3-Sided Safety Sign

- 40" high, tallest safety sign available
- High visibility Fluorescent yellow/green sign demands attention
- Helps reduce slip & fall injuries and liabilities
- 3-sided "viewing" from a distance of 35' away
- 34% more "viewing" caution space per side than 4-sided cones
- Three convenient carrying handles
- Keyhole accessory opening
- Stable, durable construction, stackable
- Dimensions: Base - 14¾" W; Top - 4¾" W x 40" H

9140AM	Caution Wet Floor	3/cs	18 lb
--------	-------------------	------	-------

## 4-Sided Safety Cone

### D Safety Cone

- Trilingual English-French-Spanish safety warnings
- Two colour red & black message for increased visibility
- Attention-getting sign locks securely into the slot on top of the cone
- Stackable for economic storage and transportation
- Cone is 36" high moulded in bright yellow with a 10" red warning sign secured on top
- Overall Dimensions: 12" Sq. Base x 46" H

1246CWF	with Red Top Sign	5/cs	21 lb
---------	-------------------	------	-------



## Safety Pylons

### E Safety Pylons

- Slim-line design provides wind resistance
- Wide weighted base adds to stability
- Flanges on base of cone provide airflow and prevent tipping of cone
- Orange pylon with embedded "Wet Floor" message on both sides that will not scratch off
- Rugged PVC construction
- Dimensions: 10½" Sq. x 18" H

125ENG	Wet Floor	6/cs	18 lb
--------	-----------	------	-------

## Closed for Cleaning Pole

### A Closed for Cleaning Safety Pole

- New flexible sign is permanently attached to pole (no need for rings)
- Tear resistant material wraps around pole for easy storage
- Fits in standard doorways, narrow hallways and aisles
- Prevents room entry during cleaning and maintenance
- Extends to 48"

9031	Closed for Cleaning Pole	24/cs	32 lb
------	--------------------------	-------	-------



## Grit & Barricade Tape

### B SafetyTrack® Black Grit Safety Tape

- Medium Coarse SafetyTrack® Rolls
- Abrasive, non-slip, high traction safety tape
- Reduces possible hazards quickly and economically
- Provides long life protection against slips, trips and falls

31001	Black	1" x 60'	12/cs	9.5 lb
31002	Black	2" x 60'	6/cs	9.5 lb
31004	Black	4" x 60'	3/cs	9.5 lb

### C Barricade Tape

- Made of heavy duty polyethylene
- Warning sign and barricade to keep people clear of hazardous areas
- Printed black on yellow
- Comes in a convenient, disposable dispenser
- 3" x 1000' per roll
- 2 mil tape
- Can be used with TriVu signage

7328	Caution	1 Roll	5 lb
------	---------	--------	------



## Right to Know

### D SDS Information Centre

- Helps comply with New GHS/SDS regulations
- Allows easy access to Safety Data Sheets
- Highly visible safety red/white sign
- Made of durable polystyren
- Includes extra large 2½" spine 3-ring SDS binder to hold new 16 part SDS's
- Mounting hardware not included
- Dimensions: 5½" D x 24" W x 18½" H

799190	Red/White	1/cs	7 lb
--------	-----------	------	------



❖ Non-stocked item requires special order



## General Purpose Gloves

### A Disposable Latex General Purpose Gloves

- Powder free, 5 mil with rolled cuff
- Natural colour
- Beaded cuff; ambidextrous
- Use for food handling and preparation, assembly and manufacturing and any non-medical application requiring dexterity

<b>8625M</b>	Medium	100/box	10/bx/cs	19 lb
<b>8625L</b>	Large	100/box	10/bx/cs	19 lb
<b>8625XL</b>	Ex Large	100/box	10/bx/cs	19 lb

### B Disposable Vinyl General Purpose Gloves

- Powder free
- Beaded cuff, ambidextrous
- FDA compliant
- Use for food preparation, general light-duty cleaning, painting, manufacturing and parts assembly

<b>8608S</b>	Small	100/box	10/bx/cs	13 lb
<b>8608M</b>	Medium	100/box	10/bx/cs	13 lb
<b>8608L</b>	Large	100/box	10/bx/cs	13 lb
<b>8608XL</b>	Ex Large	100/box	10/bx/cs	13 lb

## Chemical Resistant Gloves

### C Yellow Flock Lined Latex

- 16 mil thickness, 12" length, chlorinated finish, embossed
- Use for general cleaning, maintenance, janitorial services, hospital and housekeeping
- Chemically resists mild detergents, mild acids, alkalis, animal fats, vegetable oils and germicides
- Individually Polybagged; 1 pair per poly bag, 12 poly bags per package

<b>13835</b> ❖	Small	12 pr/pk	10 dz/cs	15 lb
<b>13836</b>	Medium	12 pr/pk	10 dz/cs	15 lb
<b>13837</b>	Large	12 pr/pk	10 dz/cs	20 lb
<b>13838</b>	Ex Large	12 pr/pk	10 dz/cs	20 lb

### D Green Flock Lined Nitrile

- 15 mil thickness, 12" length, FDA compliant, non-slip grip
- Puncture resistant; abrasion resistant
- Use for strong chemicals, stripping, degreasing, oven cleaning, harsh solvent, acid handling, auto, poultry & meat processing and dishwashing
- Chemically resists a wide range of acids, aggressive solvents, and petroleum based products
- Individually bagged

<b>8217M</b>	Medium	12 pr/pk	6 dz/cs	13 lb
<b>8217L</b>	Large	12 pr/pk	6 dz/cs	13 lb
<b>8217XL</b>	Ex Large	12 pr/pk	6 dz/cs	13 lb

❖ Non-stocked item requires special order

## Glove Dispensers

### A Protective Glove Dispenser

- Fits most 100-pack dispenser boxes of disposable latex and vinyl gloves
- Large opening for easy glove removal
- Moulded in clear acrylic to see the type of glove
- Wall mount horizontally or vertically with two-way tape (included)
- Dimensions: 10½" L x 4" D x 6" H

8615	Clear/Acrylic	12/cs	25 lb
------	---------------	-------	-------

### B Plastic Glove Dispenser for 3 Boxes

- Organize latex, vinyl and nitrile disposable gloves for quick and easy access
- Hold all glove sizes or types used in one convenient rack
- Load with multiple quantities of fast moving gloves to reduce refill frequency and out-of-stocks
- Racks do not collect dust and dirt
- May be mounted vertically or horizontally; table or wall mount for easy access

8615V3	Clear/Acrylic	4/cs	9 lb
--------	---------------	------	------

## Face Masks

### C Disposable Non-Toxic Dust Mask

- Protects from effects of pollen, dust, grass and other non-toxic particles
- Double shell construction
- N95 rating or higher
- Provides comfortable tight fitting seal
- Custom fit nosepiece adjusts to contour of face
- Constructed from polypropylene

7300B	White	50/bx	0.8 lb
-------	-------	-------	--------

### D Disposable Dust & Mist Respirator

- Protects from effects of pollen, dust, grass, and other non-toxic particles
- Double shell construction
- Provides comfortable tight fitting seal; custom fit nosepiece
- N-95 rated
- OSHA and NIOSH approved TC-21C-271

7312B	White	20/bx	0.8 lb
-------	-------	-------	--------

## Sweatbands

### E Sweatbands

- Stay cool and comfortable on the job site
- Absorbent sweatbands fit under hard hats, etc. and soak up sweat, protecting the workers' eyes
- Made of soft sponge with a stitched elastic band
- Use in kitchens, factories, warehouses and all types of construction environments

SB400	100 sweatbands/pack	4 pk/cs	11 lb
-------	---------------------	---------	-------

❖ Non-stocked item requires special order



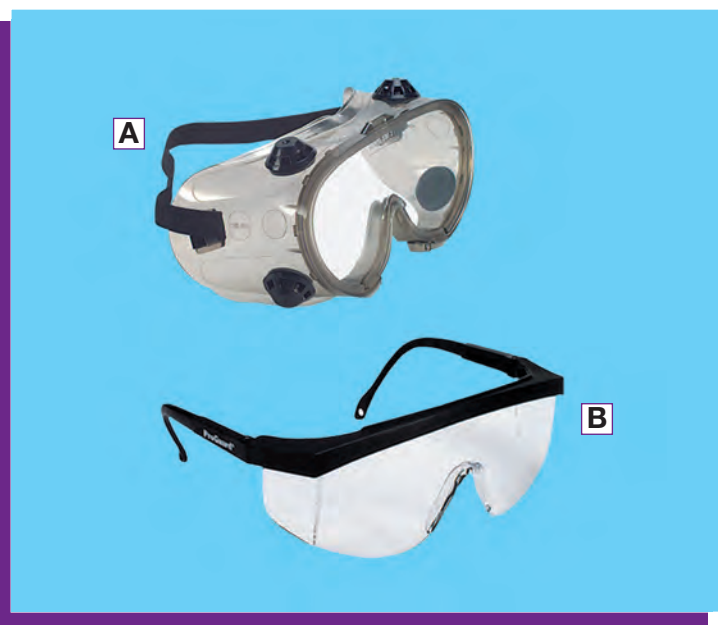

## Safety Glasses

### A Chemical Splash Goggle with Anti-Fog

- Indirect ventilation vents
- Exceeds ANSI Z87.1 2003 US standards for high impact
- Soft PVC body; adjustable elastic headband
- Polycarbonate anti-fog lens
- Fits over most prescription eyewear

<b>7320</b>	Clear	12/cs	13 lb
-------------	-------	-------	-------

### B Frontrunner™ Wraparound

- Most popular safety glasses
- Wrap-around design
- Adjustable lock-in temples
- Maximum coverage at brow and sides
- Clear, high impact and scratch-resistant polycarbonate lenses provide 99.9% UV protection
- Meets ANSI Z87.1 2003 US standards for high impact

<b>7334B</b>	Black Frame, 12/bx	12 bx/cs	21 lb
--------------	--------------------	----------	-------



## Lens Cleaning Wipes

### C Disposable Lens Cleaning Wipes

- Anti-fog; anti-static
- Silicone free
- Individually wrapped; pre-moistened
- Wall-mounted or free standing dispenser

<b>7364B</b>	100 wipes/box	6 bx/cs	7 lb
--------------	---------------	---------	------



## Sharps Containers

### D Sharps Containers

- Meet or exceed OSHA, NIOSH, CDC, and JCAHO Standards
- Puncture resistant, exceeding current ASTM standards for wall thickness
- Latex and heavy-metal free for added safety
- Designed for use in patients rooms, physicians' offices, clinics, and other high traffic areas
- Lid design limits access to container contents; containers lock for disposal
- Horizontal drop allows maximum capacity of sharps; translucent containers and lids help identify fill level
- Accommodates syringes up to 60 cc
- Nestable to save money in shipping and storage
- Built-in needle key for safe removal of needles when necessary; built-in handles for easy transport
- 2-Gallon size has wide horizontal opening for various sharp disposals (table top or wall mountable with 7352B)
- Dimensions for 7350: 4½" L x 4½" W x 6¾" H
- Dimensions for 7352: 7¼" L x 8½" W x 10" H

<b>7350</b>	1 Quart	100/cs	24 lb
<b>7352</b>	2 Gallon	30/cs	32 lb

❖ Non-stocked item requires special order



# Material Handling





## Utility Transport Carts

Heavy-duty utility carts are constructed of high-density structural plastic. These carts cannot rust or dent like comparable metal models. Structural plastic will not crack or chip and because the colour is moulded all the way through, it will not scratch off. They are light and mobile since structural plastic does not get its strength from weight. Maximum load capacity is 400 lb/181 kg.

## Heavy-Duty Utility Carts

- Available in two convenient sizes
- Standard with two shelves, each shelf holds 200 lb/91 kg
- 5" non-marking casters, two swivel and two rigid
- Catch-all pocket organizer conveniently stores tools
- Cart A shown with 8322BE Optional Waste Basket
- Cart C shown with 5806GY Optional Centre Shelf

### A Utility Cart

- Dimensions: 34 $\frac{3}{4}$ " L x 17 $\frac{1}{2}$ " W x 33" H

<b>5800BE</b>	Beige	1/cs	33 lb
<b>5800GY</b> ♦	Grey	1/cs	33 lb

### B Optional Waste Basket

- Fits 5800 and 5805 Utility Carts
- 23 gallon
- Dimensions: 11 $\frac{1}{2}$ " D x 19 $\frac{3}{4}$ " W x 30 $\frac{1}{2}$ " H

<b>8322BE</b> ♦	Beige	4/cs	27 lb
<b>8322GY</b>	Grey	4/cs	27 lb

### C Utility Cart

- Dimensions: 40 $\frac{3}{4}$ " L x 25 $\frac{1}{2}$ " W x 33" H

<b>5805BE</b> ♦	Beige	1/cs	43 lb
<b>5805GY</b> ♦	Grey	1/cs	43 lb

### D Optional Centre Shelf

- Dimensions: 30" L x 16" W (fits 5800)

<b>5801BE</b> ♦	Beige	1/cs	10 lb
<b>5801GY</b> ♦	Grey	1/cs	10 lb

- Dimensions: 36" L x 24" W (fits 5805)

<b>5806BE</b> ♦	Beige	1/cs	16 lb
<b>5806GY</b> ♦	Grey	1/cs	16 lb

## Service Cart

### E Service Cart

- Standard with three sturdy reinforced shelves
- 200 lb/91 kg capacity
- Load safety is assured with "Lock-Fit" shelves to aluminum supports
- 4" non-marking swivel casters
- Includes tool and refuse bins
- Dimensions: 36" L x 16" W x 31" H
- Outside shelf Dimensions: 25" L x 16 $\frac{1}{4}$ " W x 2 $\frac{1}{4}$ " D

<b>8008</b>	Black	1/cs	24 lb
-------------	-------	------	-------

♦ Non-stocked item requires special order

## Bussing Cart

### A Bussing Cart

- Three shelves; supports up to 200 lb/91 kg
- 4" heavy-duty, non-marking casters
- Carries large loads and reduces return trips
- Rounded corners protect walls and furniture
- Upscale appearance is ideal for any setting
- Textured shelves hold a variety of equipment and supplies
- Durable structural web construction resists scratches, chips and rust
- Lightweight and very manoeuvrable
- Use in industrial, retail, food service or bussing applications, etc.
- Dimensions: 40" L x 20" W x 38" H

7006	Grey	Large	1/cs	39 lb
------	------	-------	------	-------

## Janitor Carts

### B Janitor Cart

- With a 25 gallon heavy-duty polyethylene bag with zipper
- Accommodates one 26 or 35 quart mop bucket with wringer
- Non-marking 8" rear wheels, 3" ball-bearing swivel front casters
- Shown with small grey tote (not included)
- Dimensions: 43" L x 18½" W x 38" H

6002BL	Blue	1/cs	41 lb
6002GY	Grey	1/cs	41 lb
6003	Repl. Zipper Bag	1/cs	4.3 lb

### C Extra Large Tote

- The premium tote for convenience
- Carries all your cleaning supplies
- Divided into 3 deep compartments, for wet and dry usage
- Made from polyethylene
- Container's rugged construction provides a longer service life
- Dimensions: 15½" L x 13" W x 11" D

639	Blue	6/cs	17.5 lb
-----	------	------	---------

### D Maids' Basket

- High comfortable handle, heavy-duty construction
- High sides prevent bottles and aerosols from falling out
- Use inserts with maids' basket to hold quart bottles, etc.
- Inserts (item C) must be ordered separately
- Dimensions: 12¼" L x 11" W x 5" D

1802BL	Blue	6/cs	9 lb
--------	------	------	------

### E Inserts for Maids' Basket

- Use inserts with maids' basket (item B) to hold quart bottles, etc.
- Dimensions: 12" L x 4" W

1802IBL	Blue	Sold ea	
---------	------	---------	--

### F Portable Caddy - Bucket

- Organized cleaning system fits over rim and handle of 32, 44, and 55 gallon containers (including all competitors' models)
- Built-in features hold cleaning tools, scrapers, roll towels, plastic liners, gloves, cell phone, putty knives, sponges and more
- Two deep compartments for wet or dry usage
- Dimensions: 15" L x 14" W x 14" H

1850	Blue/Grey	4/cs	12 lb
------	-----------	------	-------

❖ Non-stocked item requires special order





## Industrial Trucks

### A Industrial Hand Truck

- Load capacity: 500 lb/226 kg
- Dimensions: 45½" H with 8" x 2" solid wheels
- Load plate: 9½" D x 14" W

174	Closed Handle	1/cs	26 lb
-----	---------------	------	-------

### B Heavy-Duty Hand Truck

- Load capacity: 800 lb/363 kg
- Dimensions: 45½" H with 10" x 3" thread-width pneumatic tires
- Load plate: 9¼" D x 14" W

177	Closed Handle	1/cs	28 lb
-----	---------------	------	-------

### C Chair & Hand Truck Combo

- Industrial chair mover hand truck
- Can be used as a regular hand truck
- Load capacity: 500 lb/226 kg
- Dimensions: 45½" H with 8" x 2" solid wheels
- Load plate: 7¾" D x 14" W
- Chair plate: 21" W

178	Closed Handle	1/cs	27 lb
-----	---------------	------	-------



## Collector Trucks

### D Metal Collector Truck

- Chrome-plated 1" metal tubular construction with 3" casters
- Wire bag support shelf
- Comes with a coated, 8 bushel bag with draw string
- Frame folds for storage
- Dimensions: 27" L x 23" W x 41¼" H

6005	With Tan Terylene Bag	1/cs	18 lb
6006	Replacement Bag	Sold ea	1 lb

### E Plastic Collector Truck

- Plastic frame with 3" casters
- Frame folds for storage
- Comes with 100 L/6 bushel polyethylene bag
- Dimensions: 28" L x 26" W x 37½" H

6007	Blue with Polyethylene Bag	1/cs	24.5 lb
6008	Replacement Bag	20/cs	15 lb

### F Vinyl Caddy Bag

- Dimensions: 24" L x 19" W

277YE	Yellow	Sold ea	0.7 lb
-------	--------	---------	--------

❖ Non-stocked item requires special order

## Telescopic Ladders

### A Telescopic Ladders

- Small, light and convenient to carry
- Made of high grade aluminum alloys made from pure ingot
- Extend the ladder by holding in an upright position with one hand firmly on one of the vertical tubes and one foot on the bottom rung - opening by gripping the top rung and fully extend the section until the ladder is open to full height
- Each section has indicators; they are red when unlocked and green when locked so you know it's safe to climb
- Patented easy and safe one-touch release system
- 100% Silicon foot that swivels to ensure the feet are perfectly flat on the floor or surface
- Compact for easy storage
- Closed height of 1400E is 2.3'
- Closed height of 1600E is 2.5'
- 250 lb maximum load capacity

<b>1400E</b>	14' Climbing Height	1/cs	18 lb
<b>1600E</b>	16' Climbing Height	1/cs	23 lb

### B Combi Ladders

- Small, light and convenient to carry
- Each section has indicators; they are red when unlocked and green when locked so you know it's safe to climb
- Comes with a convenient carry strap for use when the combi ladder is in the closed position
- Perfect for use on stairs or other uneven surfaces; simply adjust the back stabilizer bar to the correct height
- Closed height of 10ES is 29"
- Closed height of 14ES is 34"
- 300 lb maximum load capacity

<b>10ES</b>	10' Climbing Height	1/cs	18 lb
<b>14ES</b>	14' Climbing Height	1/cs	37 lb



## Step Stands

### C Step Stands

- Step up safely to out of reach items or surfaces
- Extra wide design for maximum stepping area
- Rubber feet grip floor for extra stability
- Non skid slip resistant surface
- Molded in carrying handles
- Molded from LLDPE - Chemical resistant
- Maximum 500 lb capacity
- Dimensions SS-1YE: 28" L x 20" W x 13" H
- Dimensions SS-2YE: 36" L x 28" W x 20" H

<b>SS-1YE</b> ◆	Yellow	Sold ea	13 lb
<b>SS-2YE</b> ◆	Open Handle	Sold ea	30 lb



◆ Non-stocked item requires special order

## Utility Starcarts™

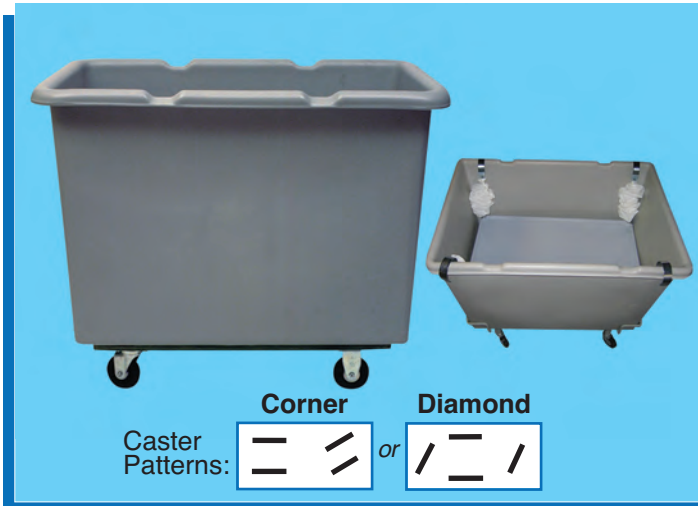

Model No.	Volume Bu Cu Ft	Inside L x W x H	Outside L x W x H	Max. Load (lb)	Standard Casters	Caster Pattern	Ship. Wt. (lb)
-----------	-----------------	------------------	-------------------	----------------	------------------	----------------	----------------

### Mini Utility Starcarts™

- 3" all swivel threadguard casters
  - Plated steel undercarriage
- Caster Pattern:  **All swivel**

<b>350AR*</b> ♦	6 7	30" x 20" x 20"	33" x 23" x 24"	200	3"	Corner	25
<b>110A</b>	7 8	31" x 21" x 21"	35" x 25" x 25"	300	3"	Corner	30

### Regular Utility Starcarts™

- 3" threadguard casters in diamond or corner pattern
- Treated 3/4" plywood undercarriage

<b>125AD</b>	10 12	35" x 23" x 25"	39" x 27" x 30"	400	3"	Diamond	40
<b>125AC</b>	10 12	35" x 23" x 25"	39" x 27" x 30"	400	3"	Corner	40
<b>125SP</b> ♦	Spring Platform	31" x 18½"	Fits 125 models				8
<b>135AD</b>	12 15	37" x 25" x 26"	41" x 29" x 31"	400	3"	Diamond	45
<b>135AC</b> ♦	12 15	37" x 25" x 26"	41" x 29" x 31"	400	3"	Corner	45
<b>145AD</b>	14 16	38" x 26" x 28"	43" x 31" x 33"	400	3"	Diamond	50
<b>145AC</b>	14 16	38" x 26" x 28"	43" x 31" x 33"	400	3"	Corner	50
<b>135SP</b> ♦	Spring Platform	34" x 22"	Fits 135 and 145 models				8

### Heavy-Duty Utility Starcarts™

- 4" threadguard casters in diamond or corner pattern
- Treated 3/4" plywood undercarriage

<b>125BD</b> ♦	10 12	35" x 23" x 25"	39" x 27" x 31"	800	4"	Diamond	50
<b>125BC</b> ♦	10 12	35" x 23" x 25"	39" x 27" x 31"	800	4"	Corner	50
<b>135BD</b> ♦	12 15	37" x 25" x 26"	41" x 29" x 32"	800	4"	Diamond	55
<b>135BC</b> ♦	12 15	37" x 25" x 26"	41" x 29" x 32"	800	4"	Corner	55
<b>145BD</b> ♦	14 16	38" x 26" x 28"	43" x 31" x 34"	800	4"	Diamond	60
<b>145BC</b> ♦	14 16	38" x 26" x 28"	43" x 31" x 34"	800	4"	Corner	60

### H.D. Oversize Utility Starcarts™

- 4" threadguard casters in diamond or corner pattern
- Treated 3/4" plywood undercarriage

<b>160BD</b> ♦	18 22	54" x 30" x 25"	59" x 35" x 32"	800	5"	Diamond	70
<b>160BC</b> ♦	18 22	54" x 30" x 25"	59" x 35" x 32"	800	5"	Corner	70
<b>180BD</b> ♦	19 24	48" x 30" x 30"	53" x 35" x 38"	800	5"	Diamond	85
<b>180BC</b> ♦	19 24	48" x 30" x 30"	53" x 35" x 38"	800	5"	Corner	85
<b>195BD</b> ♦	38 46	72" x 36" x 33"	78" x 42" x 42"	1600	5"	Diamond	115
<b>195BC</b> ♦	38 46	72" x 36" x 33"	78" x 42" x 42"	1600	5"	Corner	115

\* 350AR comes with all swivel casters, only available in black

Colours: Grey or Recycle Blue. NOTE: Blue carts are special order.



## Next Generation Starcarts™

Starcarts™ combine a single wall body with double wall box-style lip for greater durability and maximum impact resistance. The combination of poly core wheels and heavy-duty casters ensure maximum rollability and manoeuvrability.

Model No.	Volume Bu	Volume Cu Ft	Inside L x W x H	Outside L x W x H	Max. Load (lb)	Wheels	Standard Casters	Caster Pattern	Ship. Wt. (lb)
730B	14	16	41" x 27" x 28"	48" x 31" x 34½"	1000	10"	5"	Corner	80
750B	19	24	49" x 25" x 30"	60" x 31½" x 35½"	1000	12"	5"	Corner	100
770B	32	39	59" x 30" x 35"	72" x 35½" x 40"	1500	12"	6"	Corner	130

*Next Generation Starcarts™ are available in Grey upon request*

## Tilt Trucks

- Enables operator to handle large loads easily
- Rotationally moulded from FDA approved polyethylene
- Large rubber (recessed) wheels and swivel casters ensure manoeuvrability
- Nestable to minimize shipping and storage costs
- Lids are available for ¾ and 1.1 cu yd trucks
- 2" x 4" casters provide increased stability
- Increased maximum payload capacity
- Available in blue or grey
- Note: 420EC has plastic wheels



420EC



Model No.	Volume Cu Yds	Outside L x W x H	Max. Load (lb)	Wheels		Handle	Ship. Wt. (lb)
				Front	Back		
420EC ❄️	5/8	55" x 28" x 38"	300	10"	4" Caster	N/A	70
420LT ❄️	5/8	55" x 28" x 37"	400	10"	4" Caster	N/A	70
420C ❄️	5/8	58" x 29" x 38"	1000	10"	4" Caster	Moulded	85
441LT ❄️	1.1	63" x 35" x 40"	500	12"	3" Casters (2)	N/A	85
441C ❄️	1.1	68" x 36" x 42"	1200	12"	4" Casters (2)	Moulded	100
460LT ❄️	1.5	77" x 43" x 50"	600	12"	4" Casters (2)	N/A	100
460C ❄️	1.5	81" x 44" x 50"	1500	12"	4" Casters (2)	Moulded	125
480LT ❄️	2	73" x 47" x 56"	800	12"	5" Casters (2)	Steel	160
480C ❄️	2	74" x 48" x 56"	2000	12"	5" Casters (2)	Moulded	180

❄️ 420EC is only available in Black ❄️ **Non-stocked item requires special order**

NOTE: Lids are available for ¾ and 1.1 cu. yd. tilt trucks. Please contact your local representative.

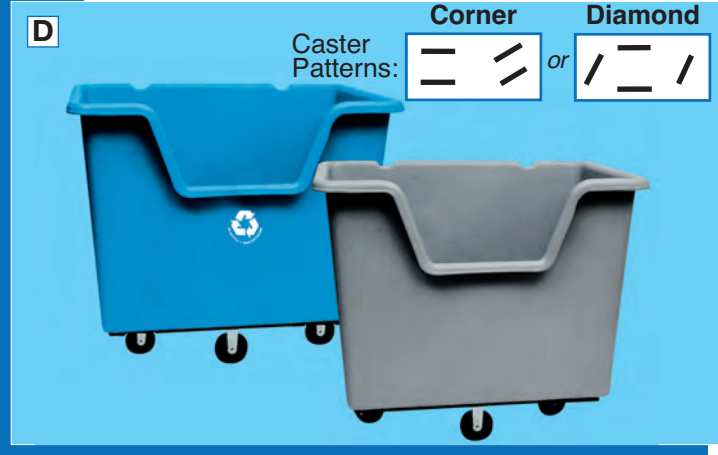

## Econocart Black

**A 8 Bushel Black Econocart**

- New ribbed design offers sidewall support
- Moulded from black recycled plastic
- 2½" all swivel casters in a corner pattern
- Maximum load capacity 175 lb
- 8 bushel/9 cubic foot capacity
- Outside dimensions: 36½" L x 24½" W x 27" H

<b>111ECS</b>	Black	Sold ea	23 lb
---------------	-------	---------	-------

**B 10 Bushel Black Econocart**

- Light-duty tub made from recycled plastic
- One piece moulded construction features smooth interior walls
- 3" all swivel casters in a corner pattern
- Treated plywood base
- Maximum load capacity 200 lb
- 10 bushel/12 cubic foot capacity
- Inside dimensions: 35" L x 23" W x 25" H
- Outside dimensions: 39" L x 27" W x 29" H

<b>125ECS</b>	Black	Sold ea	30 lb
---------------	-------	---------	-------

## Elevated Starcarts

**C Elevated Starcarts**

- 3" all swivel threadguard casters in a corner pattern
- Powder coated steel base
- Removable plastic body resists cracks and corrosion
- Maximum load capacity 200 lb
- 300E Inside dimensions: 30" L x 16" W x 16" H
- 300E Outside dimensions: 33" L x 19" W x 28" H
- 350E Inside dimensions: 30" L x 20" W x 20" H
- 350E Outside dimensions: 33" L x 23" W x 29" H

<b>300E</b>	4 bushel/5 cu ft	Sold ea	25 lb
<b>350E</b>	6 bushel/7 cu ft	Sold ea	35 lb

## Easy Access Starcarts

**D Easy Access Starcarts**

- High density polyethylene resists moisture, most chemicals and solvents
- Sidewall cutout provides easy access to stored contents
- 5" threadguard casters in a diamond or corner pattern
- Treated plywood undercarriage
- Easy access sidewall
- Available in grey or recycle blue
- Maximum load capacity 900 lb
- 165 Inside dimensions: 41" L x 27" W x 32" H
- 165 Outside dimensions: 46" L x 31" W x 39" H
- 175 Inside dimensions: 46" L x 31½" W x 48½" H
- 175 Outside dimensions: 58" L x 27" W x 32" H
- 185 Inside dimensions: 58" L x 27" W x 32" H
- 185 Outside dimensions: 63" L x 31" W x 39" H

<b>165BC</b>	Corner	18 bushel/21 cu ft	Sold ea	75 lb
<b>165BD</b>	Diamond	18 bushel/21 cu ft	Sold ea	75 lb
<b>175BC</b>	Corner	21 bushel/24 cu ft	Sold ea	85 lb
<b>175BD</b>	Diamond	21 bushel/24 cu ft	Sold ea	85 lb
<b>185BC</b>	Corner	21 bushel/24 cu ft	Sold ea	100 lb
<b>185BD</b>	Diamond	21 bushel/24 cu ft	Sold ea	100 lb

NOTE: All carts on pages 139-141 are available in custom colours by special order

## SOS™ Storage Bins

**For safe, convenient, year-round storage**

### Applications:

- **Sand/Salt:** The double wall lid and moulded in hasp will keep contents dry and secure
- **Garbage:** Ideal for rural applications. Will protect garbage bags from both pesky animals and elements
- **Dock:** Stores boating accessories and personal valuables conveniently, right on the dock
- **Baseball:** Rugged construction and weather resistance enable dry storage for bases, chalk and equipment
- **Truck:** The lockable heavy-duty hasp will ensure tools and other valuables are safe and secure
- **Pool:** Perfect storage for pool chemicals, life jackets or pool toys
- Other applications include farms, factories, trailers, ship or shore, parking lots, cottages or construction sites

### Features:

- Roto moulded of 1/4" - 5/16" gauge Linear Low Density Polyethylene (LLDPE)
- Heavy-duty construction with lockable double wall lid
- Water tight and impact resistant
- Nestable
- Four convenient sizes
- Custom colours available in quantities, call for details

### A SOS 5.5

- Dimensions: 30" L x 24" W x 24" H; 500 lb/227 kg capacity

SOS 5.5YE	Yellow	Sold ea.	35 lb
SOS 5.5GY	Grey	Sold ea.	35 lb
SOS 5.5BL ♦	Blue	Sold ea.	35 lb
SOS 5.5GN ♦	Green	Sold ea.	35 lb

### B SOS 11

- Dimensions: 42" L x 29" W x 30" H; 1000 lb/454 kg capacity

SOS 11YE	Yellow	Sold ea.	50 lb
SOS 11GY	Grey	Sold ea.	50 lb
SOS 11BL ♦	Blue	Sold ea.	50 lb
SOS 11GN ♦	Green	Sold ea.	50 lb

### C SOS 18

- Dimensions: 48" L x 33" W x 34" H; 1750 lb/794 kg capacity

SOS 18YE ♦	Yellow	Sold ea.	65 lb
SOS 18GY ♦	Grey	Sold ea.	65 lb
SOS 18BL ♦	Blue	Sold ea.	65 lb
SOS 18GN ♦	Green	Sold ea.	65 lb

### D SOS 36

- Dimensions: 72" L x 36" W x 36" H; 3500 lb/1588 kg capacity

SOS 36YE ♦	Yellow	Sold ea.	88 lb
SOS 36GY ♦	Grey	Sold ea.	88 lb
SOS 36BL ♦	Blue	Sold ea.	88 lb
SOS 36GN ♦	Green	Sold ea.	88 lb

♦ Non-stocked item requires special order

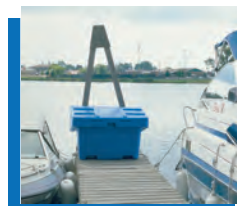
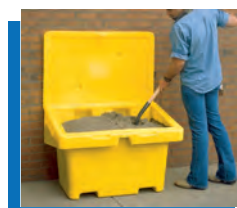



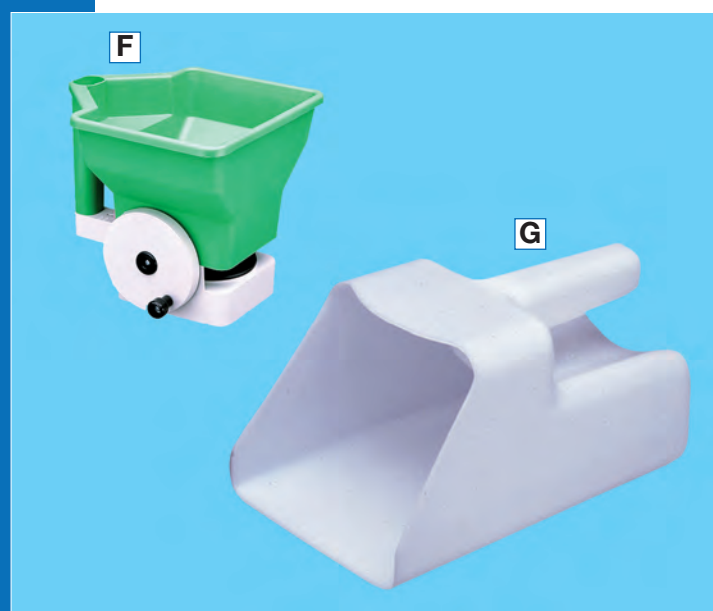

## Spreaders

### A Push Pneumatic Spreader

- For use with ice melter or fertilizer; not rock salt
- Features 10" pneumatic tires on rustproof poly rims
- Poly hopper holds up to 80 lb/36 kg
- 100 lb/45 kg load bearing capacity
- Heavy-duty high speed gearbox
- EV-N-SPRED® 3-Hole drop shut-off system

<b>2050P</b>	Red	1/cs	15 lb
--------------	-----	------	-------

### B Protective Rain Cover

- Keeps ice melter or fertilizer clean and dry - protected from the elements
- Clear cover allows for easy viewing of hopper levels
- Fits snugly on the 2050P, 2040Pi Plus and 2130 Spreaders

<b>77003</b>	Black/Clear	Sold ea	3 lb
--------------	-------------	---------	------

### C Deflector Kit

- Protects flower beds, gardens, etc. from receiving unwanted fertilizer, salt or ice melter
- Fits 2050P only - mounts easily; hardware included

<b>77122</b>	Black	Sold ea	2 lb
--------------	-------	---------	------

### D Semi Pro High Output Spreader

- For use with ice melter or rock salt; not fertilizer
- Equipped with 9" high flotation pneumatic tires that glide over rough surfaces
- Rust-proof poly hopper and rims
- Heavy-duty poly hopper holds up to 65 lb/30 kg
- 100 lb/45 kg load bearing capacity
- Solid linkage controls and a high speed gearbox
- Even application of ice melter ensures professional results
- Outperforms all other spreaders of its size and price

<b>2040PiPlus</b>	Blue	1/cs	16 lb
-------------------	------	------	-------

### E Commercial High Output Spreader

- For use with rock salt or ice melter; not fertilizer
- Adjustable height handle and 13" pneumatic stud tires provide optimal comfort and control
- Rust-proof poly hopper and rims
- Heavy-duty poly hopper holds up to 65 lb/30 kg
- 175 lb/79 kg load bearing capacity
- Solid linkage controls and a super-duty gearbox

<b>2130</b>	Blue	1/cs	27 lb
-------------	------	------	-------

## Scoops

### F Handi-Spreader

- Ideal tool to spread ice melt
- Covers area 6' to 12' wide with three convenient settings
- Capacity of 6 lb pelletized material
- Rust and corrosion-proof

<b>5450</b>	Green/White	6/cs	9 lb
-------------	-------------	------	------

### G Deluxe Scoop

- Poly-clear is lighter weight than aluminum or glass
- Durable, resists chipping, scratches and breakage
- Beveled front edge for maximum pick up
- Hanging slot for efficient storage
- Thumb indent for greater control and comfort
- Reinforced gussets prevent flexing and breakage

<b>2405</b>	White, 2 Quart/1.9 L	12/cs	8 lb
-------------	----------------------	-------	------



# Auto Detailing



## Trunk Buddy System

### A Trunk Buddy Strap

- Protect, secure and transport items in your car trunk without damaging your items or your vehicle
- Fits all cars, minivans and SUV's

<b>T100</b>	Trunk Buddy Strap	10/cs	3.5 lb
-------------	-------------------	-------	--------

### B Trunk Buddy Telescopic

- Prevents the trunk lid from bouncing
- Ten different positions to accommodate small or large items
- Fits all cars, minivans and SUV's
- Extends from 20" to 29"

<b>TB120</b>	Trunk Buddy Telescopic	10/cs	6.5 lb
--------------	------------------------	-------	--------

## Interior Auto Cleaners

### C Interior Detailer

- Quick drying, greaseless and streakless matte finish detail product
- Enhance and recondition the appearance of dash boards, vents, mouldings and consoles that aren't made of rubber or vinyl
- VOC compliant

<b>780</b>	net wt. 12 oz	12/cs	14 lb
------------	---------------	-------	-------

### D Fabric Cleaner Plus

- Effectively removes soils from most upholstered fabrics, including velour, cloth and carpeting
- The high foam does not soak into fabric, but leaves it clean and dry with a fresh wintergreen scent
- Helps leave car and truck interiors with a "like new" look and smell
- Use on RV carpets, office partitions, upholstered furniture and marine upholstery

<b>508</b>	net wt. 19 oz	12/cs	18 lb
------------	---------------	-------	-------

### E Fabric Cleaner

- Quickly and effectively removes soils from most upholstered fabrics
- Cleans without leaving the fabric wet
- The inverted valve allows for cleaning hard to reach areas
- Leaves the surface clean and dry with a fresh spearmint fragrance
- Use on most upholstered fabrics including velour, cloth and carpeting, RV carpets, office partitions, upholstered furniture and marine upholstery
- Use as a spotter or a cleaner for fast soil removal
- High foam quickly penetrates and emulsifies soils

<b>558W</b>	net wt. 19 oz	12/cs	18 lb
-------------	---------------	-------	-------

### F Leather Cleaner & Conditioner

- Cleans, conditions, renews and preserves leather surfaces
- Contains no silicones
- Provides a water repellent treatment to protect the fabric
- Adds moisture to leather surfaces, restoring suppleness
- Rich foam specially formulated with emollients, humectants, proteins, surfactants and conditioners to clean, condition and preserve strength and resiliency of new and old leather
- New leather fragrance

<b>SW991</b>	net wt. 14 oz	12/cs	14 lb
--------------	---------------	-------	-------

❖ Non-stocked item requires special order



## Exterior Auto Cleaners

### A Instant Detail Cleaner & Polish

- Quick detail touch-up; spray and wipe clean
- Rinse free
- Use between waxes to maintain that 'showroom quality shine'
- Gentle enough to use every day and safe for all paint types
- Removes harmful contaminants, fingerprints, water spots and surface dirt; repels water while adding protection to your finish

094	net wt. 16 oz	12/cs	16 lb
-----	---------------	-------	-------

### B Instant Detail Wax

- Wax in minutes; no buffing necessary
- No powder or dust residue
- Adds a 'showroom quality shine' with very little effort
- Wax your entire vehicle in minutes with protection, water-beading and shine that lasts for weeks
- Apply a light mist and wipe with a dry, clean towel or microfibre cloth

096	net wt. 16 oz	12/cs	16 lb
-----	---------------	-------	-------

### C Instant Shine

- A great final detail product with a silicone based coating designed to treat vinyl, fabric, leather and polycarbonate substrates
- Specially formulated for vinyl, body mouldings, engine compartments and other polycarbonate substrates, including hard to reach air conditioner ducts
- Spray on and buff or let dry to a like new shine

936	net wt. 11 oz	12/cs	12 lb
-----	---------------	-------	-------

### D Low Pro Tire Shine

- Ideal for use on low profile and all other tires
- High-gloss tire shine gives your tires a long-lasting wet look
- Helps restore body and moisture to dried-out tires and trim
- Custom spray pattern is perfect for narrow or low profile tires, allowing you to spray and go
- No wiping required

SW930	net wt. 14.5 oz	12/cs	15 lb
-------	-----------------	-------	-------

### E Brake Parts Cleaner

- Quickly removes grease, dirt, brake fluid and grime from critical brake components
- Flush away contaminants without disassembling the brake unit
- Non-chlorinated and Hexane-free
- High pressure spray evaporates fast
- Restores smooth brake operation
- Use on valve covers, clutch housings, clutch pressure plates and transmission

SW070	net wt. 14 oz	12/cs	14 lb
-------	---------------	-------	-------

### F Glass Cleaner

- The most versatile glass cleaner available - cleans glass, windows, mirrors, windshields, enamel surfaces, chrome, tile, porcelain and other hard surfaces
- Dissolves dirt, grease, grit and grime
- Heavy-duty foam clings to vertical surfaces
- Guaranteed to leave no film
- Contains perfume-grade alcohol for best performance

SW050CC	net wt. 19 oz	12/cs	18 lb
---------	---------------	-------	-------





## Vehicle Brushes

### A Car/Truck Wash Brush

- Cleans cars, trucks, windows or vinyl siding
- Plastic block with vinyl bumper to protect surfaces from scratches during cleaning
- Made of soft, split-tip fibre
- Fountain hole allows water to reach the cleaning area
- Accepts 1" and 1½" threaded handles
- Dimensions: Overall length 10" with 2½" trim

<b>685510</b>	Black Block/Green Fill	12/cs	12.5 lb
---------------	------------------------	-------	---------

### B Flow Thru Dip & Wash Brush

- 5" round spray brush; ideal for siding and windows
- Flow thru design; using a flow thru handle, water will be dispersed through the brush head
- Fits on a standard thread, long tapered or flow thru handle
- Dimensions: 5" dia. x 4½" H

<b>661</b>	Red, Medium	6/cs	7 lb
<b>662</b>	Grey, Stiff	6/cs	7 lb

For Handles, see page 58



### C Poly Whisk

- 2-string; synthetic fill
- 10" long - 4" from second string; bonded in a plastic cap
- Great for quick clean up of larger particles

<b>416W</b>	Blue Cap/Grey Fill	10/cs	5 lb
-------------	--------------------	-------	------

### D Detail Brush

- 8" soft grip plastic handle with nylon bristles
- Ideal for cleaning small, hard-to-reach areas
- Excellent for a variety of cleanin applications, including grout cleaning

<b>562</b>	Detail Brush	48/cs	5 lb
------------	--------------	-------	------



## Auto Squeegees

### E Auto Squeegee Scrubber

- Gentle scrubber with durable rubber squeegee
- Sponge is wrapped in honeycomb scrubbing nylon
- Easy to use - just scrub, flip and squeegee
- Comes with 20" handle, 10" Wide Head

<b>9100</b>	Auto Squeegee	10/box	9.5 lb
-------------	---------------	--------	--------

### F Telescopic Squeegee

- Great for all your hard-to-reach cleaning demands
- A quick twist extends handle from 39" to 64"
- Scrubbing sponge covered with durable nylon mesh

<b>9491</b>	Telescopic Squeegee	12/cs	14 lb
-------------	---------------------	-------	-------



### G Stain-Sorb Liquid Stain Absorbent

- Highly effective against oils, greases, BBQ grill stains, silicone oils from tire dressings and other stains
- Ideal for use on asphalt, concrete, paving stones, pressure treated wood, composite decking and other surfaces
- Apply by pouring, spraying or brushing onto stained surfaces
- Quickly dries to a powder for easy removal; no scrubbing or rinsing necessary
- Biodegradable

<b>15912</b>	32 oz/946 mL	12/cs	30 lb
--------------	--------------	-------	-------

❖ Non-stocked item requires special order

## Microfibre Cloths

- Breakthrough technology, one of the best cleaning tools
- With millions of tiny, super absorbent strands, these cloths can actually reach down inside the smallest indentations of any surface
- New patented hemming finish keeps the cloth in its original shape with no migration of lint or threads
- 80% Polyester, 20% Polyamide material
- Machine washable and can be dried in a standard dryer at a low temperature (**Caution:** Do not use bleach or fabric softener)

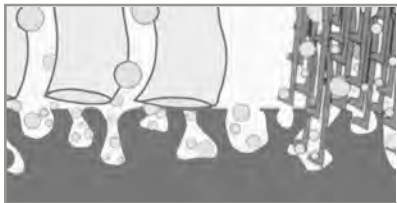

Conventional Microfibre

### A Microfibre—SuperPro

- Knitted with patented hemming
- 300 gsm face weight
- Machine washable up to 1000 times

<b>A30102</b>	Blue	16" x 16"	10/pk	200/cs	24 lb
<b>A30103</b>	Red	16" x 16"	10/pk	200/cs	24 lb
<b>A30105</b>	Yellow	16" x 16"	10/pk	200/cs	24 lb
<b>A30106</b>	Green	16" x 16"	10/pk	200/cs	24 lb
<b>A50102</b>	Blue	14" x 14"	10/pk	200/cs	24 lb
<b>A50103</b>	Red	14" x 14"	10/pk	200/cs	24 lb
<b>A50105</b>	Yellow	14" x 14"	10/pk	200/cs	24 lb
<b>A50106</b>	Green	14" x 14"	10/pk	200/cs	24 lb

### B Microfibre Mitt without Thumb

- A great choice for dusting and cleaning
- Safe for dusting and cleaning without chemicals or oils
- Microfibre dusters have the same great qualities as cloths but can be used in harder to reach areas like ceiling fans, shelves and irregular surfaces
- Can be laundered

<b>LFRMIT</b>	Blue	180/cs	24 lb
---------------	------	--------	-------

## Microfibre Bar Wipes

- Overlock stitched hem prevents fraying, improving the life of the cloths
- Lint free; more absorbent than terry towel cloths
- Cloths can be laundered as much as 500 times

### C MaintenancePro White Microfibre Bar Wipe

- Ribbing on both sides improves scrubbing and drying action
- Standard hospitality blue stripe on both sides

<b>A40100</b>	14" x 18"	10/pk	200/cs	24 lb
---------------	-----------	-------	--------	-------

### D MaintenancePro White Microfibre Bar Wipe

- Ribbing on one side; scrub with one side and neatly wipe away any mess; standard hospitality blue stripe on one side only
- Regular microfibre on the other side for cleaning dishes or use as a damp/dry dusting and polishing cloth

<b>A40101</b>	14" x 18"	10/pk	200/cs	24 lb
---------------	-----------	-------	--------	-------





## Trigger Sprayers

### A General Purpose Trigger Sprayer

- **Leading general purpose trigger sprayer in the janitorial and industrial markets**
- Rubber piston cup extends life and provides broader chemical resistance while the outer body protects the piston assembly to prevent damage during use and storage
- Use for restroom and window cleaning, housekeeping, in car washes, for auto detailing, pest control, lawn care
- 1.4 mL output per stroke
- Fits 28 mm - 400 thread finish

<b>5111RW</b>	8"	Red/White	200/cs	20 lb
<b>5111BW</b>	8"	Blue/White	200/cs	20 lb
<b>5112RW</b>	9¼"	Red/White	200/cs	20 lb
<b>5112BW</b>	9¼"	Blue/White	200/cs	20 lb

### B Upside Down Trigger Sprayer

- Works From Any Angle
- Patented design allows you to use the sprayer in any direction... even completely upside down!
- Unique design allows user to completely empty contents of the bottle
- Non-leaking
- Use for restroom cleaning, housekeeping, window cleaning, in car washes, for auto detailing, pest control, lawn care
- 1.0 mL output per stroke
- Fits 28 mm - 400 thread finish

<b>110450</b>	9¼"	White	200/cs	18 lb
---------------	-----	-------	--------	-------

### C Chemical Resistant Trigger Sprayer

- 5112CR is formerly the #110542
- Nozzle O-ring and piston cup are made of chemical resistant synthetic rubber
- Ergonomically designed extra long trigger provides unsurpassed comfort
- Extra large spray pattern
- 1.4 mL per stroke
- Fits 28 mm - 400 thread finish

<b>5111CR</b>	8"	Grey	200/cs	22 lb
<b>5112CR</b>	9¼"	Grey	200/cs	22 lb

### D Acid Resistant Trigger Sprayer

- Not intended for use with solvent solutions
- Unsurpassed acid resistance; proprietary design extends product life when used with acid solutions
- Outer body protects piston assembly to prevent damage during use and storage
- Designed specifically to be used with acid-based wheel cleaners
- 1.4 mL output per stroke significantly reduces the number of times you pull the trigger
- Fits 28 mm - 400 thread finish

<b>5111AR</b>	8"	Gold/Black	200/cs	22 lb
<b>5112AR</b>	9¼"	Gold/Black	200/cs	22 lb

❖ Non-stocked item requires special order

## Foamer Trigger Sprayers

### A Foamer Trigger Sprayer

- Three-finger trigger and rear support makes extended use more comfortable
- Foaming action helps reduce the consumption of chemicals
- 1.4 mL output per stroke significantly reduces the number of times you pull the trigger
- Fits 28 mm - 400 thread finish

9111WF	8"	White	200/cs	18 lb
9112WF	9 1/4"	White	200/cs	18 lb

## High Output Trigger Sprayer

### B High Output Trigger Sprayer

- Self-venting to prevent bottle collapsing
- Oversized trigger for 3 finger activation, prevents hand fatigue
- Over 3 times normal output per stroke, 3.2 mL
- Fits 28 mm - 400 thread finish

8112RW	9 1/2"	Red/White	100/cs	17 lb
--------	--------	-----------	--------	-------

## LEGEND

### Tube Lengths:

- 7 1/4" fits 16 oz bottle
- 7 1/4" - 7 1/2" fits 22 oz Colossal bottle
- 8" - 8 1/8" fits 24 oz bottle
- 9 1/4" - 10" fits 32 oz bottle

## Bottles

### C 24 oz Round Bottles

- Moulded oz/mL and dilution ratios
- High density polyethylene, 28 mm/400 neck finish

12174	24 oz	Natural	105/cs	10.5 lb
-------	-------	---------	--------	---------

### D 24 oz Round W.H.M.I.S. Bottle

- Moulded oz/mL and dilution ratios
- High density polyethylene with screened red W.H.M.I.S. panel
- 28 mm/400 neck finish

29036	24 oz	Natural	100/cs	8 lb
-------	-------	---------	--------	------

### E 32 oz Handi-Hold Bottle

- Without graduations, 28 mm/400 neck finish
- Made with high density polyethylene

17425	32 oz	Natural	92/cs	12 lb
-------	-------	---------	-------	-------

### F 32 oz Handi-Hold & W.H.M.I.S. Bottle

- Without graduations
- High density polyethylene with screened red W.H.M.I.S. panel
- 28 mm/400 neck finish

29223	32 oz	Natural	92/cs	12 lb
-------	-------	---------	-------	-------

❖ Non-stocked item requires special order







# KNOCK DOWN™

## "Round for Round"

### TOTAL BUG PROTECTION™

KNOCK DOWN™ Products KILL your insects and solve your pest control problems with one knock out blow!

Insects go down and stay Down for the count!



## Index

### A

Absorbents .....	109
Ace Blend Mops .....	55
Acid Resistant Trigger .....	112
Acid Sprayer Gun .....	118
Acrylic Bow Swabs .....	17
Adhesives, Remover .....	105
Advantage Dispensers .....	7 - 8
Aerosol Adhesives .....	91
Aerosol Disinfectants & Cleaners .....	83 - 84
Aerosol Dispensers, Metered .....	85
Aerosol Fabric, Deodorizers .....	86
Aerosol Furniture Polish .....	83
Aerosol Glass Cleaners .....	83
Aerosol Industrial Maintenance .....	91
Aerosol Insecticides .....	89 - 90
Aerosol Metal Polish .....	88
Aerosol Odour Counteractants .....	85 - 86
Aerosol Paint Removers .....	84
Air Freshenser Cabinets .....	25 - 26, 85
Air Freshener Cartridges .....	25 - 26
Air Freshener Systems .....	25 - 26, 85 - 86
Air Fresheners .....	25 - 26, 85 - 86
Air Sanitizers .....	86
Alcohol Free Wipes .....	92
All Purpose Cleaners .....	100 - 101
All Purpose Plunger .....	18
All Purpose Scrub Brush .....	63 - 64
All Purpose Squeegees .....	123
All Purpose Wipers .....	97, 147
Aluminum Handles .....	58
Aluminum Polish .....	88, 102
Aluminum Window Squeegees .....	122 - 123
Angle Brooms .....	59
Angle Broom, Large .....	59
Anti-slip Tape .....	131
Antibacterial Hand Cleaner .....	7 - 9
Antimicrobial Treated Hand Pads .....	38
Applicators, Floor Finish .....	56
Ash Receptacles .....	81 - 82
Attack Air Freshener .....	86
Atomizer .....	120
Auto Squeegee Scrubbers .....	123, 146
Automatic Aerosol Products .....	85
Automatic Bowl Cleaner .....	19 - 20
Automatic Soap Dispenser .....	4, 7, 10
Automatic Urinal & Toilet Fixtures .....	19 - 20

### B

Baby Care Station .....	26
Back Flip .....	124
Back Pack Applicator System .....	51
Back Reliever Sprayer .....	118
Bak-Pak Sprayer .....	120
Bacterial/Enzyme Products .....	103 - 104
Bag, Janitor .....	136
Bag, Laundry Net .....	43
Bag in Box Hand Soap .....	8
Bag in Box Soap Dispenser .....	8
Bagger, Nifty Nabber .....	60
Bags, Carts and Trucks .....	136 - 137
Bags, Sanitary Napkin .....	15
Barrel Faucets .....	115
Barricade Safety Signs .....	130 - 131
Barricade Tape .....	131
Battery Acid Cleaning Wipes .....	93
Bed Bug Killer .....	89
Beige Floor Pads .....	29
Beverage Dispenser .....	12
Big Blue Bowl Cleaner .....	23
Bins, Garbage .....	68 - 71
Bins, SOS Storage .....	142
Blocks, Urinal/Bowl/Wall .....	21
Blue Boxes .....	79
Blue Velvet Burnishing Floor Pads .....	29
Boat Brushes .....	64

Bonnets, Carpet .....	34
Bottles & Sprayers .....	110 - 113
Bowl Blocks .....	21
Bowl Brushes .....	17 - 18
Bowl Caddies .....	17
Bowl Cleaners .....	23
Bowl Clip .....	23
Bowl Mops .....	17 - 18
Bowl Rim Hangers .....	23
Brace, Push Broom .....	57
Brackets, Wall .....	114
Brass Polish .....	88, 95, 102
Brass Squeegees .....	121
Breakaway Frames & Handles .....	41
Bricks, Grill .....	39
Broom Braces .....	57
Broom Handles .....	58
Broom Hanger .....	58
Brooms, Push .....	57
Brush Moss Squeegee .....	47
Brushes, Flow Through .....	58
Brushes, Utility .....	63
Brushes, Vehicle .....	146
Buckets, Utility .....	44 - 45
Buckets, Window .....	127
Buckets, Wringers .....	49
Buffing, Floor Pads .....	28
Bug Killers .....	89 - 90
Bulk Soap .....	9
Bullet Receptacles .....	71
Bullseye Recycling Containers .....	78
Bullseye Receptacles .....	73, 78, 80 - 81
Bumblebee Hook .....	70
Burnishing Floor Pads .....	29
Burnishing Pads, Microfibre .....	33
Bussing Carts .....	136
Butt Receptacles .....	81 - 82

### C

Cabinets, Air Freshener .....	85
Caddies, Maids .....	136
Caddy, Bowl Cleaner & Brush .....	17 - 18
Caddy, Wheeled .....	77
Cam Down Pressure Wringer .....	49 - 50
Can/Bottle Recycling Containers .....	77 - 79
Candle Wax Remover .....	84
Cans, Garbage/Waste .....	68 - 71
Car Squeegees .....	123, 146
Carpet Bonnets .....	34
Carpet Bonnets, Microfibre .....	34
Carpet Care, Liquids .....	104
Carpet Cleaners, Liquid .....	104
Carpet Deodorants .....	86
Carpet Groomers & Sweepers .....	34
Carpet Spot Remover, Liquid .....	104
Carpet Spray Cleaning System .....	43
Cart Bags .....	136
Cart Handle Wipes .....	94
Cart, Maids .....	136
Carts, Bussing .....	136
Carts, Janitor .....	136
Carts, Utility .....	139 - 140
Cartridge Air Fresheners .....	25 - 26
Caution Tape .....	131
Caution Wet Floor Signs .....	130
Cease Fire Outdoor Ash Container .....	82
Cellulose Sponges .....	36
Centre Pull Dispenser .....	14, 94
C-Fold/ Multi Fold Dispenser .....	13
Chair & Hand Truck Combo .....	137
Change Table .....	26
Channels, Squeegee .....	121 - 123
Chemical Brackets .....	114
Chemical Pumps .....	116 - 118
Chemical Resistant Broom .....	59
Chemical Resistant Gloves .....	132
Chemical Resistant Sprayers .....	118

Chemical Resistant Trigger Sprayers .....	111
Chemical Splash Goggles .....	134
Chewing Gum Remover .....	84
Chrome Polish .....	88, 95, 102
Chrome Roll Dispensers .....	12
Chrome Toilet Tissue Dispenser .....	11
Clean Bee Broom .....	59
Clean Screen Wipes .....	127
Cleaners, Antibacterial .....	99
Cleaners, Bathroom .....	101
Cleaners, Bowl .....	101
Cleaners, Brass .....	88, 95, 102
Cleaners, Chrome .....	88, 95, 102
Cleaners, Degreasers .....	100 - 101
Cleaners, Floor .....	108 - 109
Cleaners, Furniture .....	83
Cleaners, Glass .....	83, 102
Cleaners, Granite .....	83
Cleaners, Griddle .....	39
Cleaners, Hand .....	7 - 10, 92 - 93
Cleaners, Industrial .....	91
Cleaners, Metal .....	88, 95, 102
Cleaners, Multi-Purpose .....	100 - 101
Cleaners, Vinyl, Rubber & Leather .....	87, 145
Cleaning Cloths .....	96 - 98, 147
Cleaning Guns & Sprayers .....	118 - 119
Cleaning Pads .....	36 - 39
Cleaning, Griddle .....	39
Clear Vu Soap Dispensers .....	4, 6
Clips for Lobby Broom .....	61
Clips, Squeegee .....	121
Closed for Cleaning Pole .....	131
Cloths, Cleaning .....	96 - 98, 147
Collector Truck .....	137
Combos, Buckets & Wringers .....	49
Concrete Protector .....	109
Cone Bowl Mops .....	17
Cones, Safety .....	130
Conqueror Odor Counteractant .....	107
Container Caddy .....	77
Container Dolly .....	69
Container Lids .....	69
Container, Sharps .....	134
Containers .....	68, 70 - 74
Conventional Floor Pads .....	28
Corn Brooms & Whisks .....	59, 62
Corrosive Resistant Sprayers .....	118
Cotton Dust Mops .....	41
Cotton Mop Heads .....	55
Cotton Yacht Mops .....	55
Counter Mount Soap Dispensers .....	5, 6, 10
Counter Top Brushes .....	64
Covers, Toilet Seat .....	16
Cube Trucks .....	139 - 141
Cup Dispenser .....	12
Cups, Measuring .....	114
Curbsider Collector .....	79
Curve Air Freshener .....	3
Cyclone-D Diamond Floor Pads .....	31

### D

Deck Mops .....	55
Deck Scrub Brushes .....	64
Degreasers .....	83, 100 - 101
Degreasing Guns .....	118 - 120
Deluxe Angle Lobby Broom .....	61
Deluxe Scoops .....	114
Deodorant Wall Cabinets .....	24 - 26
Deodorant, Aerosols .....	85 - 86
Deodorant, Blocks/Pucks .....	21, 23 - 24
Deodorizing Urinal Screens .....	1, 21 - 22
Desk & Saddle Tote .....	79
Detail Brushes .....	63, 146
Detergent, Powder .....	101
Diamond Floor Pads .....	30 - 31
Digester, Odour .....	103
Digester, Drain .....	103 - 104

## Index

Dilution Control Systems.....	115
Disinfectant, Aerosols.....	84, 99
Disinfectant, Liquid.....	99
Dispenser Stands.....	94
Dispensers, Air Freshening.....	85
Dispensers, Paper Towel.....	12 - 14
Dispensers, Sanitary Napkin.....	16
Dispensers, Soap.....	4 - 10
Dispensers, Toilet Seat Cover.....	16
Dispensers, Toilet Tissue.....	11, 13
Dispensing, Accessories.....	115 - 117
Dispensing, Pumps.....	116 - 117
Disposable Dust Mops.....	42
Disposable Gloves.....	132
Disposable Masks.....	133
Disposable Urinal & Toilet Mats.....	20
Disposable Napkin Bins.....	15
Divided Pails.....	45
Dollies.....	69
Dome Top Lids.....	69
Dome Urinal Screen.....	1
Double Vertical Tissue Dispenser.....	11, 13
Down Pressure Wringers.....	49, 50
Drain Opener.....	101
Drain Plungers.....	18
Drip Dispenser.....	19 - 20
Drip Sponge.....	40
Drum Faucets.....	115
Drum Pumps.....	116
Drum Spigots.....	115
Dry Deodorizers.....	86
Dryers, Hand.....	14
Duralon Bowl Mops.....	17
Duro Moss Squeegees.....	46
Dust Cloths.....	96 - 97, 147
Dust Cloths, Yellow Treated.....	96
Dust Magnet Dry Mop System.....	42
Dust Mop Frames & Handles.....	41
Dust Mop Treatment, Aerosol.....	84
Dust Mops.....	40 - 41
Dust Pans.....	61 - 62
Duster Brush.....	64
Dusters & Tools.....	66 - 67

### E

Easy Access Star Carts.....	141
Easy Change Mop Sticks.....	54
Easy Fresh Air Freshener.....	3
Eco Air.....	2
Eco Clip.....	2
Eco Fresh System.....	1 - 3
Econo Toy Corn Broom.....	61
Econocarts.....	141
Economy Pails.....	44
Economy Sponge Mop.....	53
Electric Hand Dryers.....	14
Elevated Star Carts.....	141
Emerald Hy-Pro Floor Pads.....	32
Enduro Cloths.....	98
Energizer Batteries.....	14
Enviro Care.....	9, 99 - 109
Eradicator Sponge.....	39
Eraser, Sponge.....	39
Ergo Tec Ninja Aluminum Squeegee.....	122
Ergo Tec Scraper.....	129
Ergo Toilet Bowl Brush & Swab.....	18
Exam Gloves.....	132
Expandable Grip Tool Holders.....	58
Extended Dusters.....	66 - 67
Extension Poles.....	126
Extension Ladders.....	138
Exterior Auto Cleaners.....	145
Eye Goggles.....	134

### F

Fabric Cleaners.....	88
Face Masks.....	
Fan Deodorizer Systems.....	25 - 26
Fan Mops.....	55
Faucets, E-Z Fill.....	115
Feather Dusters.....	66
Feminine Hygiene Products.....	16
Fibreglass Handles.....	58
Finish Applicators.....	56
Finish Mops.....	56
Fire Resistant Containers.....	71
Flat Mops.....	52
Flat Mop Frame & Handle.....	51, 53
Flat Mop Systems.....	51 - 53
Flagged Push Brooms.....	57
Flexible Dusters.....	66 - 67
Flock Lined Gloves.....	132
Floor Care, Liquids.....	108 - 109
Floor Finish, Applicators.....	56
Floor Finish Mops.....	56
Floor Finish.....	109
Floor Finish Strippers.....	108
Floor Pads, Steel Wool.....	33
Floor Pads.....	28 - 33
Floor Pads, Diamond.....	31
Floor Pads, Rectangular.....	30
Floor Scrapers.....	48
Floor Signs.....	130
Floor Squeegee Handles.....	58
Floor Squeegees.....	46 - 47
Flow Through Handle.....	58
Flow Through Brushes.....	63, 64, 146
Foam & Sanitizer Guns.....	119
Foam Guns.....	119
Foam Soap.....	7, 9
Foam Soap Dispensers.....	4 - 5, 7
Foamaster Wash Guns.....	119
Foamer Trigger Sprayer.....	112
Foaming Hand Cleaners.....	7, 9
Fogger.....	120
Folding Safety Cones.....	130
Food Service Carts.....	135 - 136
Food Service Gloves.....	132
Food Service Pumps.....	117
Food Service Scoops.....	114
Food Service Wipes & Towels.....	97 - 98
Frames, Dust Mop.....	41
Fruit Fly Trap.....	90
Funnel Top Receptacles.....	72
Funnels.....	114
Furniture Polish & Cleaner.....	83

### G

Gallon Pumps.....	117
Galvanized Buckets.....	50
Galvanized Garbage Cans.....	70
Galvanized Mop Bucket/Wringer.....	50
Galvanized Pails.....	45
Galvanized Wring Easy.....	50
Garbage Cans.....	68 - 71
Gear Down Combo Pack.....	49, 50
Gear Down Pressure Wringer.....	49, 50
Gel Air Freshener.....	25
Germicidal Aerosol Spray.....	84
Germicidal Cleaner.....	84
Glass Cleaner, Aerosol.....	83
Glass Cleaner, Liquid.....	102
Glass Washers.....	124 - 125
Glasses, Safety.....	134
Glove Dispensers.....	133
Gloves, Chemical Resistant.....	132
Gloves, Disposable.....	132
Goggles, Safety.....	134
Golden Gloves.....	125
Grabbers & Pickers.....	60

Graffiti Barrier.....	106
Graffiti Remover.....	84, 106
Granite Cleaner & Polish.....	83
Granite Grey Receptacles.....	73, 80 - 81
Grease & Waste Digester.....	103 - 104
Green Flock Lined Gloves.....	132
Grill Bricks & Pads.....	39
Grout-Aide.....	65
Grout Brushes.....	63, 65
Grout Repair.....	65
Grout Spray Cleaning System.....	43
Gum Remover.....	84

### H

Half Round Wall Hugger.....	74
Halves, Sponges & Scrubbers.....	36 - 37
Hand & Nail Scrub Brush.....	64
Hand Cleaning Towels.....	92, 93
Hand Dryers.....	14
Hand Held Spreaders.....	143
Hand Mitt, Microfibre.....	97, 147
Hand Pad & Sponges.....	36 - 39
Hand Sanitizers.....	7, 8, 92
Hand Scrub Brush.....	64
Hand Soap Dispensers.....	4 - 10
Hand Soap.....	7 - 10
Hand Trucks.....	137
Handle Wipes.....	94
Handles, Broom.....	58
Handles, Dust Mop.....	41
Handles, Fibreglass.....	58
Handles, Floor Squeegee.....	47
Handles, Flow Through.....	58
Handles, Metal.....	58
Handles, Mop.....	54
Handles, Telescopic.....	126
Handles, Wood.....	58
Hands Free Soap Dispensers.....	4, 7, 10
Hard Surface Cleaners.....	100 - 101
Heavy Duty Step Stand.....	138
High Access Tools.....	128
High Dusting Tools.....	128
High Output Trigger Sprayer.....	112
Holders, Pad.....	35
Holders, Tool.....	58
Holsters, Window Cleaning.....	124
Hooded Dust Pan.....	61
Hooded Wall Ashtrays.....	81
Hose, Never Lift Bucket.....	49
Hotel Size Soap Pads.....	39
Huskee Sweepers.....	34
Hygienic Dust Mops.....	42

### I

Indoor/Outdoor Receptacles.....	71
Industrial Aerosols.....	91
Industrial Cleaners.....	91
Industrial Hand Trucks.....	137
Industrial Lubricants.....	91
Industrial Soap Dispensers.....	5
Industrial Sprayers.....	118
Industrial Step Stand.....	138
Industrial Storage Containers.....	142
Industrial Trucks & Carts.....	137, 139 - 141
Infant Change Table.....	26
Infectious Waste Containers.....	134
Insecticides.....	89 - 90
Inserts for Maids Baskets.....	136
Interior Auto Cleaners.....	144

### J

Janitor Cart & Trolley.....	136
Janitor Dust Pans.....	61 - 62
Janitor Mop Handles.....	54
Jumbo Soap Pads.....	39

## Index

### K

Kitchen Cleaner.....	101
Kitchen Klenzer.....	101
Knives, Putty.....	128
Knock Down Products.....	89 - 90

### L

Ladders.....	138
Lambswool Dusters.....	66
Latex Gloves.....	132
Laundry Carts.....	137
Laundry Detergent.....	101
Laundry Net Bag.....	43
Lens Cleaning Wipes.....	134
Lever Roll Towel Dispensers.....	
Lid-Openers.....	114
Lids, Receptacles.....	69, 70, 75
Lint Rollers.....	43
Liqui-Bac.....	104
Liquid All Purpose Cleaner.....	100 - 101
Liquid Drain Cleaner.....	101
Liquid Bacterial Cleaners.....	103 - 104
Liquid Hand Soaps.....	8, 9, 10
Liquid Soap Dispensers.....	5 - 7, 8, 10
Liquid Toilet Bowl Cleaner.....	101
Litter Pickers.....	60
Litter Receptacles.....	68 - 76
Litter Scoops.....	60
Lobby Brooms & Clips.....	61
Lobby Dust Pans.....	61
Looped Dust Mops.....	40
Looped End Finish Mops.....	56
Looped Mops.....	55
Lotion Cleanser.....	
Lotion Soap.....	8, 9, 10
Lotion Soap Dispensers.....	
Lubricants, Industrial.....	5 - 7, 8, 10

### M

Maids Baskets & Inserts.....	136
Maid's Caddy.....	136
Marathon Scoop Hoops.....	60
Mark Eraser.....	39
Material Handling Carts.....	139 - 141
Material Safety Data Holder.....	131
Measuring, Cups & Scoops.....	114
Medical Exam Gloves.....	132
Medical Waste Receptacles.....	74, 134
Melamine Sponges.....	39
Melamine Doodlebug Pad.....	35
Melamine Floor Pads.....	32
Metal Buckets.....	50
Metal Cleaner.....	88, 95, 102
Metal Collector Truck.....	137
Metal Dust Pans.....	62
Metal Lobby Dust Pan.....	61
Metal Pails.....	45
Metal Polish.....	88, 95, 102
Metal Receptacles.....	70, 72
Metal Scouring Pads.....	37
Metal Soap Dispensers.....	5
Metal Step On Cans.....	74
Metal Threaded Handles.....	58
Metal Toilet Tissue Dispensers.....	11
Metal Waste Baskets.....	76
Metered Aerosol Air Fresheners.....	85
Metered Aerosol Dispensers.....	85
Microfibre Applicator System.....	51
Microfibre Burnishing Pads.....	33
Microfibre Carpet Bonnets.....	34
Microfibre Cloths.....	95, 147
Microfibre Cloths, Quatguard.....	96
Microfibre Dusters.....	67
Microfibre Floor Cleaning Kit.....	51
Microfibre Pocket Dust Mop.....	40
Microfibre Window Washer.....	125

Mirror & Glass Cleaners.....	83, 102
Mop Bucket & Wringers.....	49
Mop Handles.....	54
Mop Pails.....	44 - 45
Mopping Tanks.....	50
Mops, Bowl.....	17
Mops, Dust.....	40 - 41
Mops, Sponge.....	53
Moss Floor Squeegees.....	46 - 47
Mosquito Shield.....	90
Motorized Deodorant Cabinets.....	26
Motsenbocker's Lift Off.....	105 - 106
MSDS Holders.....	131
Multi-Fold Towel Dispenser.....	13
Multilingual Safety Signs.....	130
Multi-Purpose Cleaners.....	100 - 101
Multi Roll Toilet Tissue Dispenser.....	11, 13

### N

Nail Brush.....	64
Napkin Bags.....	15
Napkin Dispensers.....	16
Napkin Disposal.....	15
Napkins, Sanitary.....	16
Next Generation Starcarts.....	140
Nifty Nabber Bagger.....	60
Nitrile Gloves.....	132
Non-Para Block & Screen.....	21
Non-Para Super Block.....	24
Non-Para Urinal/Toss Blocks.....	21
Non-Slip Vinyl Safety Tape.....	131

### O

OdoBan Odor Eliminator.....	101
Odour Control.....	1 - 3, 85 - 86, 107
Odor-Out Rug & Room Deodorizer.....	107
Odour Encapsulators.....	86
One Shot Automatic Soap System.....	10
Open Sesame Drain Flush.....	101
OptiLoc Extension Poles.....	126
Ostrich Feather Dusters.....	66
Outdoor Ash Tray.....	81 - 82
Outdoor Receptacles.....	71
Outdoor Storage Containers.....	142
Oval Buckets.....	50
Oven Cleaners.....	83
Omni Gels.....	25

### P

Pad Holders.....	35
Pads, Floor.....	28 - 33
Pads, Hand.....	37 - 38
Pads, Scouring.....	37 - 38
Pads, Soap.....	39
Pads, Steel Wool.....	39
Pads, Utility.....	35
Pail Lid Openers.....	114
Pail Pumps.....	116
Pails, Utility.....	44 - 45
Paint & Graffiti Remover.....	84, 106
Pans, Dust.....	61 - 62
Paper Cup Dispensers.....	12
Paper Toilet Seat Covers.....	16
Paper Towel Dispensers.....	12 - 14
Para Blocks.....	21
Para Urinal Screens.....	21
Pickers & Grabbers.....	60
Peach Burnishing Floor Pads.....	29
Pink Burnishing Floor Pads.....	29
Pink Lotion Hand Cleaners.....	7, 8, 9
Plastic Collector Trucks.....	137
Plastic Dust Pans.....	62
Plastic Funnels.....	114
Plastic Lobby Dust Pans.....	61
Plastic Maid's Baskets.....	136
Plastic Mop Buckets.....	49
Plastic Mop Handles.....	54

Plastic Pails.....	44
Plastic Safety Signs.....	130
Plastic Scouring Pads.....	37
Plastic Soap Dispensers.....	4 - 8
Plastic Squeegees.....	47
Plastic Swing Top Receptacles.....	74
Plastic Toilet Tissue Dispensers.....	11, 13
Plastic Twister Pails.....	50
Plastic Waste Receptacles.....	76
Plungers.....	18
Pneumatic Spreaders.....	143
Pocket Mop, Microfibre.....	40
Pocket Scraper.....	128
Poles, Telescopic.....	126
Polishing Pads, Floor.....	28
Polywool Dusters.....	67
Portable Caddy - Bucket.....	70
Portion Aids.....	115
Powder Free Gloves.....	132
Power Clean, Laundry Detergent.....	101
Premium Looped Dust Mops.....	40
Pro Spin System.....	53
Proxi Stain Remover.....	104
Pucks, Deodorant.....	21
Pumie Scouring Stick.....	17
Pumie Toilet Bowl Ring Remover.....	17
Pump Up Sprayers.....	118 - 119
Pumps, Drum.....	116
Push Brooms.....	57
Pylons, Safety.....	130

### Q

Quick Change Mop Handles.....	54
Quick Wipes.....	94

### R

Rags.....	98
Ranger Mops.....	55
Reach Extension Poles.....	126
Reachers and Pickers.....	60
Receptacle, Sanitary Napkin.....	15
Receptacles, Ash.....	81 - 82
Receptacles, Recycling.....	77 - 81
Receptacles, Waste.....	68 - 76
Rectangular Floor Pads.....	30
Rectangular Pails.....	44
Recycling Containers.....	77 - 81
Recycling Stations.....	80 - 81
Respirator Mask.....	133
Restroom Cleaners.....	101
Rim Cages.....	23
Roll Towel Dispensers.....	12 - 14
Round Wastebaskets.....	76
Rollers, Lint.....	43
Rubber Blade Refills.....	121, 122, 123
Rubber Gloves.....	132
Rug & Room Deodorizer.....	107
Rug & Upholstery Cleaner.....	88, 104

### S

S.O.S Storage Bins.....	142
SDS Information Centre.....	131
Saddle Totes.....	79
Safety Goggles.....	134
Safety Pylons.....	130
Safety Scraper.....	128
Safety Signs.....	130
Salt & Sand Bins.....	142
Sandscreen Floor Pads.....	33
Sandstone Receptacles.....	73
Sanitary Napkin Receptacles.....	15
Sanitary Napkins.....	16
Sanitizer, Hand.....	7, 8, 92
Sanitizing Soap.....	7, 8
Scented Urinal Screens.....	22
Scoop Hoops.....	60
Scoops.....	114

## Index

Scouring Hand Pads .....	37, 38	Surgical Gloves .....	132	Vendors-Napkins/Tampons .....	16
Scouring Sponges.....	36 - 37	Sweatbands .....	133	Vertical Toilet Tissue Dispenser.....	11, 13
Scrapemaster .....	128	Sweepers, Carpets & Floor .....	34	Vinyl Gloves .....	132
Scrapers .....	128	Sweeping Brooms .....	57, 59	Vinyl, Rubber & Leather Cleaners.....	87, 88
Screen Cleaning Wipes.....	127	Swing Top Receptacles, Plastic .....	72, 74	Visa Versa Window Washer .....	124
Screens, Urinal .....	21 - 22	Swivel Scrub Brush .....	63		
Scrub Brush .....	63 - 64	Synthetic Moss Squeegees .....	46 - 47	<b>W</b>	
Scrubber Sponges .....	36 - 37	Synthetic Yacht Mops.....	55	Wall Ash Trays .....	81
Scrubbers, Window .....	125			Wall Blocks (Para).....	24
Scrubbing Pads .....	37, 38	<b>T</b>		Wall Brackets.....	114
Scrubs In A Bucket .....	93	Tampico Push Brooms .....	57	Wall Mop Heads .....	40
Seamless Stainless Steel Pail.....	45	Tampons.....	16	Wall Mount Swing Top Receptacles.....	27, 72
Seat Cover Dispenser .....	16	Tank Soap Dispenser .....	4, 6	Wall Mounted Ash Receptacles .....	81
Seat Covers .....	16	Tank Sprayers .....	118, 120	Wall Mount Wipes Brackets .....	94
Service Carts.....	135	Tanks, Mopping .....	50	Wall Tool Holder .....	58
Shampoo, Hair & Body.....	8	Tape Remover .....	105	Wall Washer Pads.....	40
Sharps Containers .....	134	Tapered Handles .....	58	Wall Washer .....	40
Sheila Shine .....	88, 102	TCell Odor Control System .....	25	Warehouse Brooms .....	57, 59
Shop Towels.....	98	Telescopic Dusters .....	66, 67	Wash Guns.....	119
Shower Sweep Squeegee.....	123	Telescopic Poles .....	127	Washers, Glass.....	124 - 125
Side Press Wringer .....	49, 50	Terminator 2 Disinfectant .....	99	Washers, Window & Glass .....	124 - 125
Sideward Pressure Combo .....	49, 50	Terry Towel Cloths.....	98	Waste Baskets .....	76
Signs, Wet Floor.....	130	Textured Receptacles.....	73	Waste Digester .....	103 - 104
Silicone Spray .....	91	Thin Bins & Lids .....	73	Waste Receptacles .....	68 - 75
Single Fold Towel Dispensers .....	12	Threaded Handles.....	58	Water Cup Dispensers .....	12
Siphon Pumps .....	116	Tile & Grout Brushes .....	65	Waterless Hand Cleaner Dispenser.....	4 - 8
Slim Bin .....	73	Tile & Grout Repair .....	65	Wave Urinal Screen .....	1
Slim Line Carpet Bonnets .....	34	Tile Spray Cleaning System.....	43	Wax & Finish Mops .....	56
Smazer Trigger Sprayers.....	111	Tilt Trucks.....	140	Wax Applicators .....	56
Smoke Conqueror Odor Counteractant .....	107	Tilt n' Wheel Container .....	77	Wax Removers.....	84
Smoke Sponges.....	39	Toilet & Urinal Floor Mats .....	20	Wax Strippers.....	108
Smoke Urns .....	81 - 82	Toilet Bowl Blocks .....	23	Waxed Liner Bags.....	15
Smoker's Cease Fire .....	82	Toilet Bowl Brushes.....	17	Wet Floor Signs.....	130
Smoking Stand.....	81 - 82	Toilet Bowl Caddies.....	17	Wet Mop Handles.....	54
Snap on Dust Mop Frames .....	41	Toilet Bowl Cleaners.....	23, 101	Wet Mops .....	55
Soap Dispensers.....	4 - 10	Toilet Plungers.....	18	Wheeled Spray Wagon .....	120
Soap Pads.....	39	Toilet Seat Cover Dispenser.....	16	Whisk Brooms.....	62, 146
Specialty Lubricants .....	91	Toilet Seat Covers .....	16	WHMIS Bottles .....	113
Speed Change Mop Handles .....	54	Toilet Seat Wipes Dispenser .....	92	Window Brush .....	146
Spigots .....	115	Toilet Tissue Dispensers.....	11, 13	Window Cleaning Bucket .....	127
Spill Absorbent .....	109	Tool Holders .....	58	Window Scrapers.....	128
Sponge Mops.....	53	Toss Blocks .....	21	Window Squeegees .....	121 - 124
Sponge, Erasers .....	39	Total Release Air Fresheners .....	86	Window Washing Brushes .....	146
Sponge, Microfibre .....	36	Total Release Insecticide .....	89	Window Washing Equipment .....	121 - 127
Sponges .....	36	Touchless Fixtures .....	10	Wipes Dispenser Stands.....	94
Spot Remover .....	104	Towel Dispensers .....	12, 13, 14	Wipes, Wall Mount Brackets .....	94
Spray Bottles .....	113	Toy Brooms .....	61	Wipes, Alcohol Free .....	92
Sprayers, Industrial .....	118 - 120	Traffic Cones .....	130	Wipes, Disinfectant .....	92
Sprayers, Triggers .....	110 - 112	Trash Cans .....	68 - 75	Wipes, Graffiti Remover .....	95
Spreader, Ice Melter.....	143	Trash Picker .....	60	Wipes, Hand Cleaners & Sanitizers.....	92, 93
Spring Platforms.....	139	Trigger Sprayers.....	110 - 112	Wipes, Metal Cleaner & Polish.....	95
Squeegee Handles.....	47	TriVu Safety Sign .....	130	Wringers, Metal .....	50
Squeegees, Floor.....	46 - 47	Trucks, Hand.....	137		
Squeegees, Window .....	121 - 124	Trucks, Tilt.....	140	<b>X Y Z</b>	
Stain Removers.....	104	Trunk Buddy .....	144	Yacht Mops .....	55
Stain-Sorb .....	109				
Stainless Steel Ash Tray .....	81	<b>U</b>			
Stainless Steel Cleaner.....	88, 95, 102	Ultra High Speed Floor Pads .....	29		
Stainless Steel Pail .....	45	Ultra Steel Wool Floor Pads.....	33		
Stainless Steel Toilet Tissue Dispenser.....	11	Under Desk Container.....	79		
Stainless Steel Window Squeegees .....	122	Universal Gels.....	25		
Starcarts.....	139, 140, 141	Upside Down Trigger .....	111		
Steel Wool Floor Pads .....	33	Urinal & Toilet Floor Mats .....	20		
Steel Wool Hand Pads .....	39	Urinal Blocks/Pucks .....	21		
Step Ladders, Extension .....	138	Urinal Screens .....	21 - 22		
Step Stand .....	138	Utility Brushes .....	63		
Step-On Receptacles, Metal .....	74	Utility Carts.....	139 - 141		
Storage Containers .....	142	Utility Hooks .....	58		
Street Brooms .....	57	Utility Pads & Holder .....	35		
Strip Washers.....	125	Utility Pails .....	44 - 45		
Stripping Boots.....	43	Utility Star Carts .....	139		
Stripping Pads.....	32	Utility Wipers .....	97 - 98		
Suction Cup Reacher .....	60			<b>V</b>	
Super 20lb Para Block .....	24	Vandalism Mark Remover .....	84, 106		
Super Bucket.....	127	VanGuard Receptacles .....	71		
Super Scraper.....	128	Vehicle Brushes .....	146		
Super Sorb.....	109				



# Our business is making your business more successful.

At RDA Advantage, we know that you work hard to provide on-time delivery, easy ordering and great customer service. It's why we work tirelessly to provide the same to you – all at a very competitive price. Because when you succeed, so do we.

**RDA advantage™**  
There's no better way to buy.

[www.rdaadvantage.com](http://www.rdaadvantage.com)



[www.GeorgianBayChemical.com](http://www.GeorgianBayChemical.com)



**519-470-6000**  
**1-855-470-6001**

# **Georgian Bay Chemical**

---

**121 Jason Street, Owen Sound, ON N4K 5N7 (Springmount Business Park)**  
**[www.GeorgianBayChemical.com](http://www.GeorgianBayChemical.com) Fax : 866-370-2527**  
**[info@georgianbaychemical.com](mailto:info@georgianbaychemical.com)**